



US00D415687S

United States Patent [19]

Lai et al.

[11] Patent Number: **Des. 415,687**

[45] Date of Patent: **** Oct. 26, 1999**

[54] CONTAINER

[75] Inventors: **John W. Lai**, San Francisco, Calif.;
Peter Simpson, Glencoe; **Thomas J. Melk**, Chicago, both of Ill.

[73] Assignee: **Outer Circle Products, Ltd.**, Chicago, Ill.

[**] Term: **14 Years**

[21] Appl. No.: **29/098,979**

[22] Filed: **Jan. 8, 1999**

Related U.S. Application Data

[63] Continuation of application No. 29/071,263, May 21, 1997.

[51] LOC (6) Cl. **09-01**

[52] U.S. Cl. **D9/523; D9/522**

[58] Field of Search **D9/523, 572, 575, D9/526, 522; 215/382, 383**

[56] References Cited

U.S. PATENT DOCUMENTS

D. 194,071 11/1962 Anderson D9/523

Primary Examiner—Lucy Lieberman

Attorney, Agent, or Firm—Trexler, Bushnell, Giangiorgi & Blackstone, Ltd.

[57] CLAIM

The ornamental design for a container, as shown and described.

DESCRIPTION

FIG. 1 is a perspective view of the container showing the design with a threaded neck shown in broken line, this broken line element is provided for illustrative purposes only and forms no part of the claimed design;

FIG. 2 is a front elevational view thereof, a rear elevational view is not provided as it is a mirror image of the front elevational view;

FIG. 3 is a right side elevational view thereof;

FIG. 4 is a left side elevational view thereof;

FIG. 5 is a top plan view thereof;

FIG. 6 is a bottom plan view thereof; and,

FIG. 7 is a top, front and left side perspective view of a second embodiment of the container.

The second embodiment differs from the first embodiment only in the changes in proportions that are shown in FIG. 7. The broken lines in the drawings are for illustrative purposes only and do not form part of the claimed design.

1 Claim, 3 Drawing Sheets

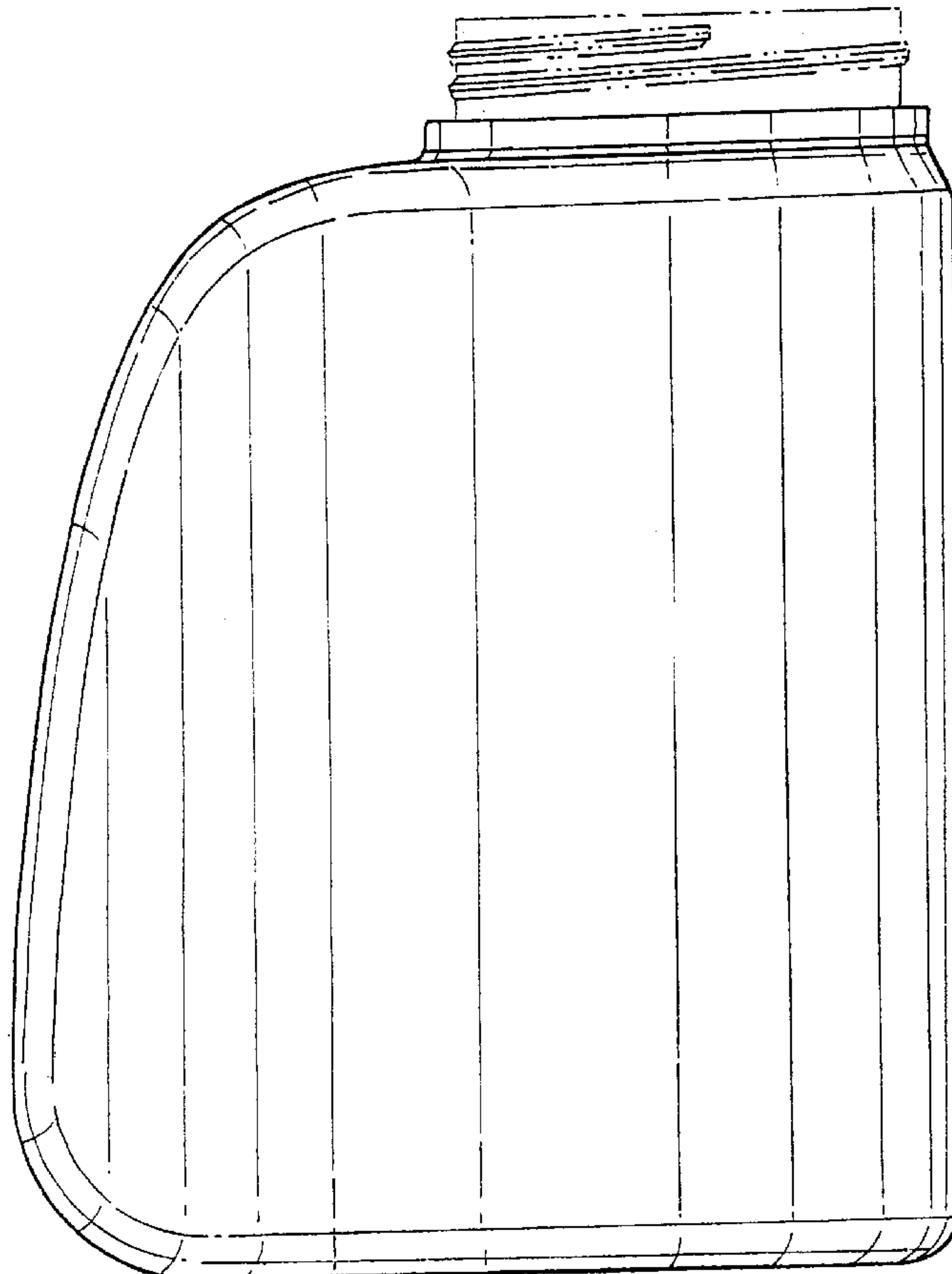

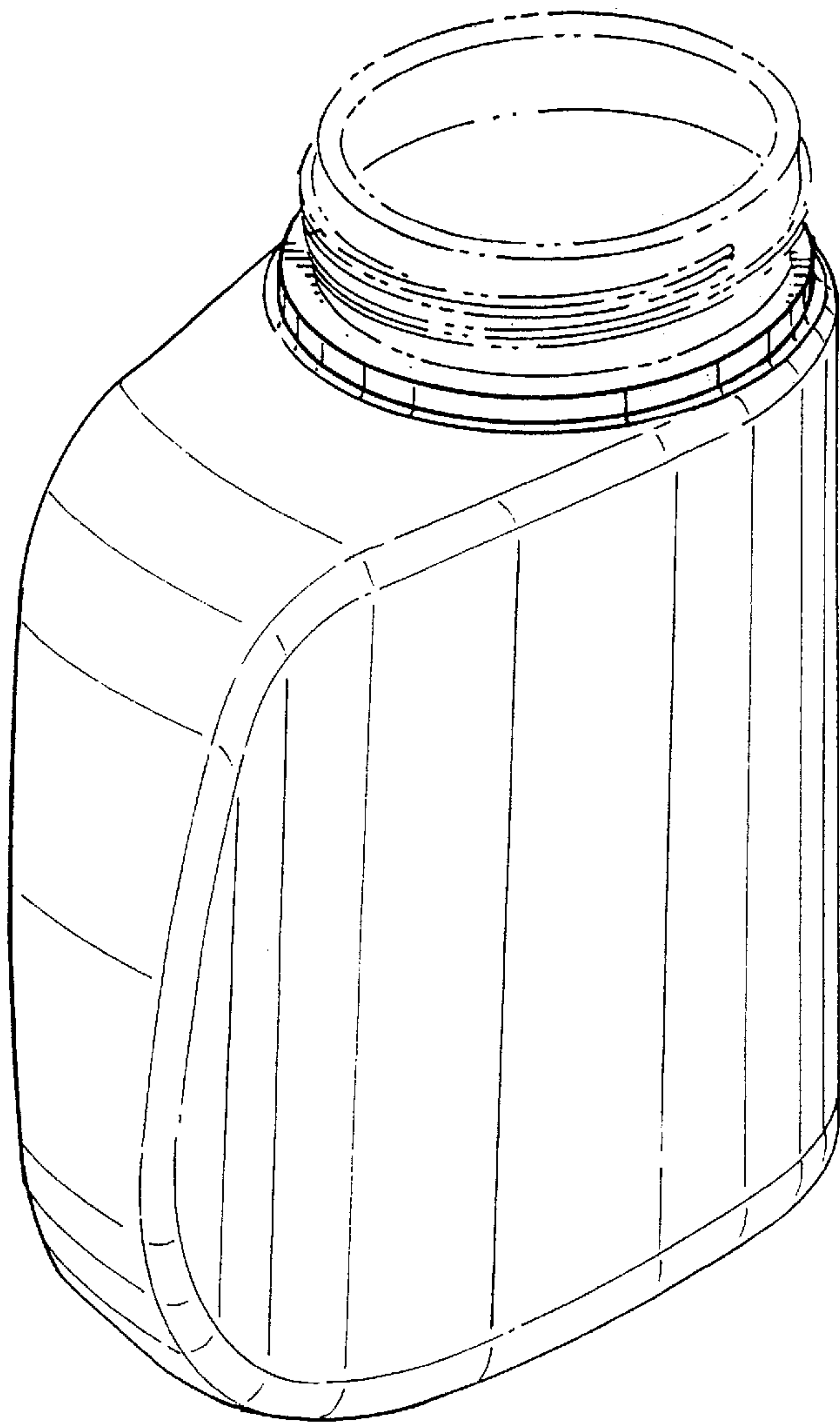

FIG. 1

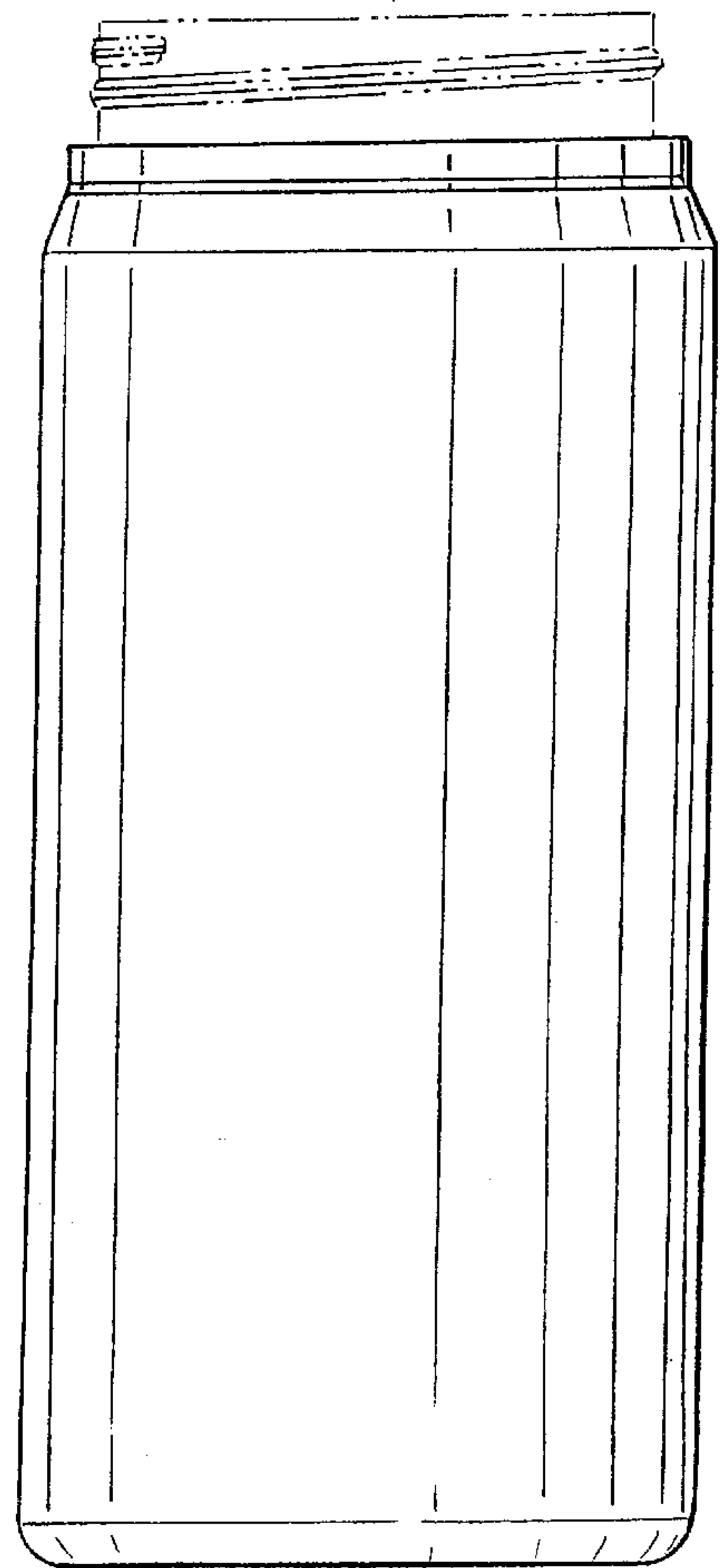

FIG. 3

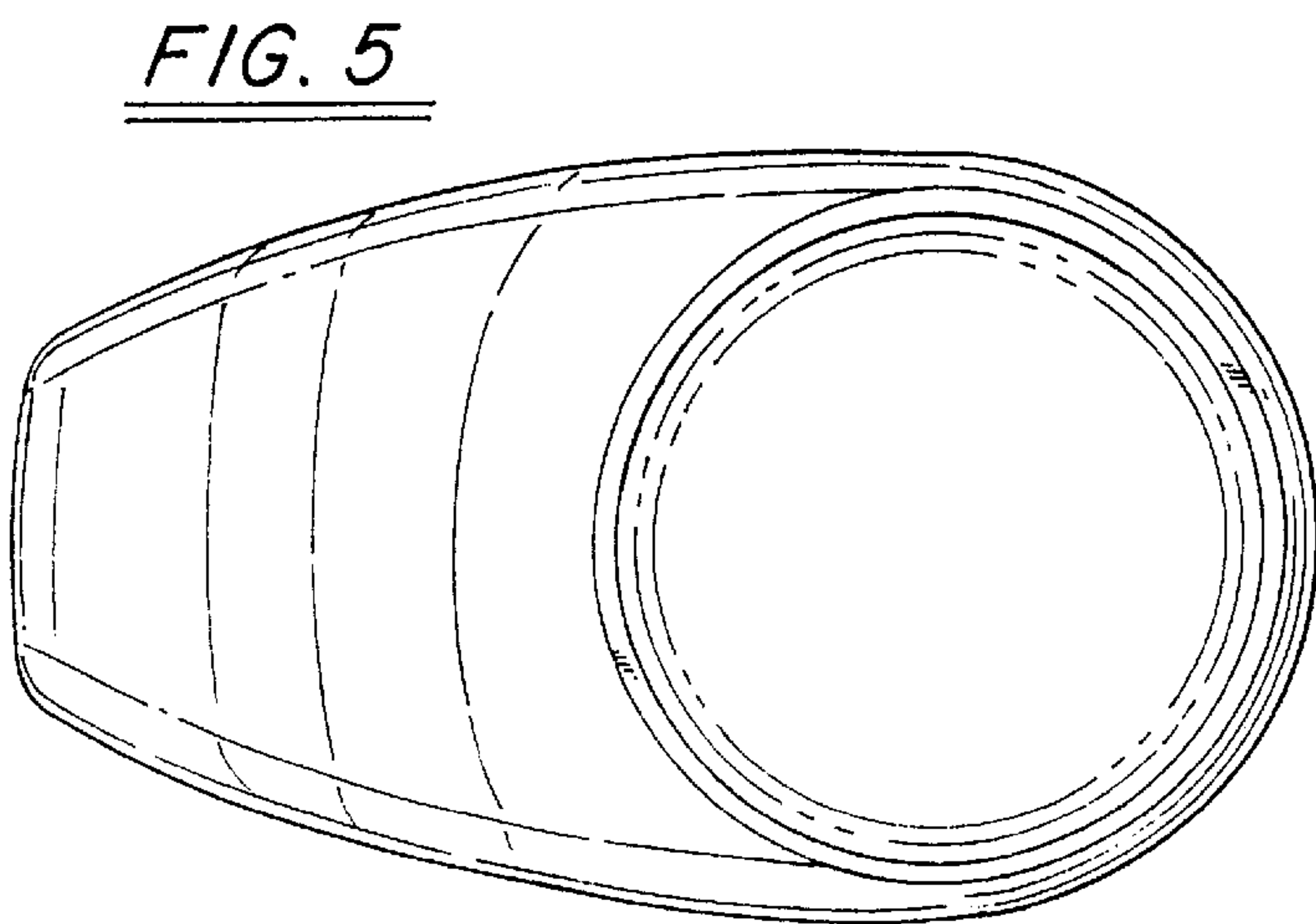

FIG. 5

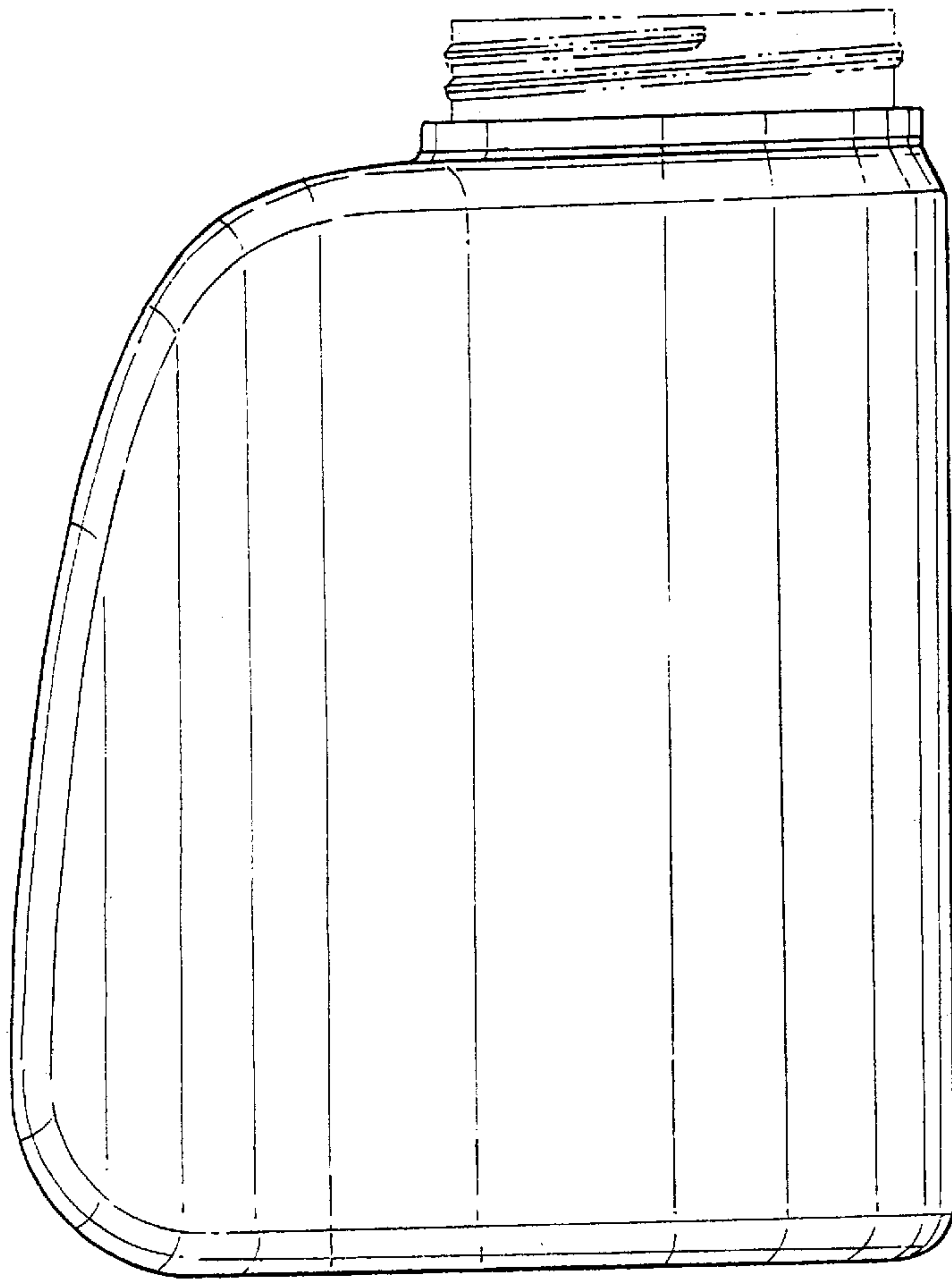

FIG. 2

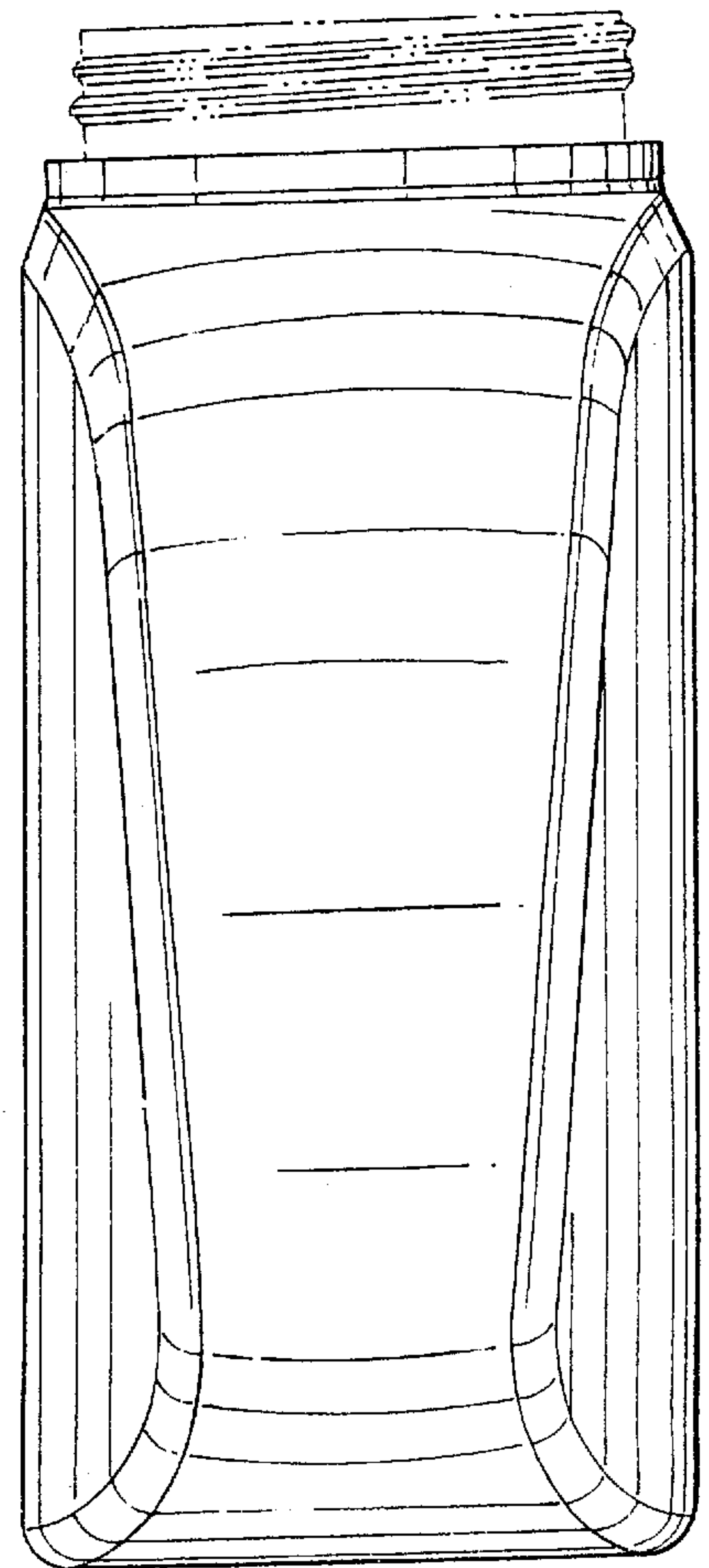

FIG. 4

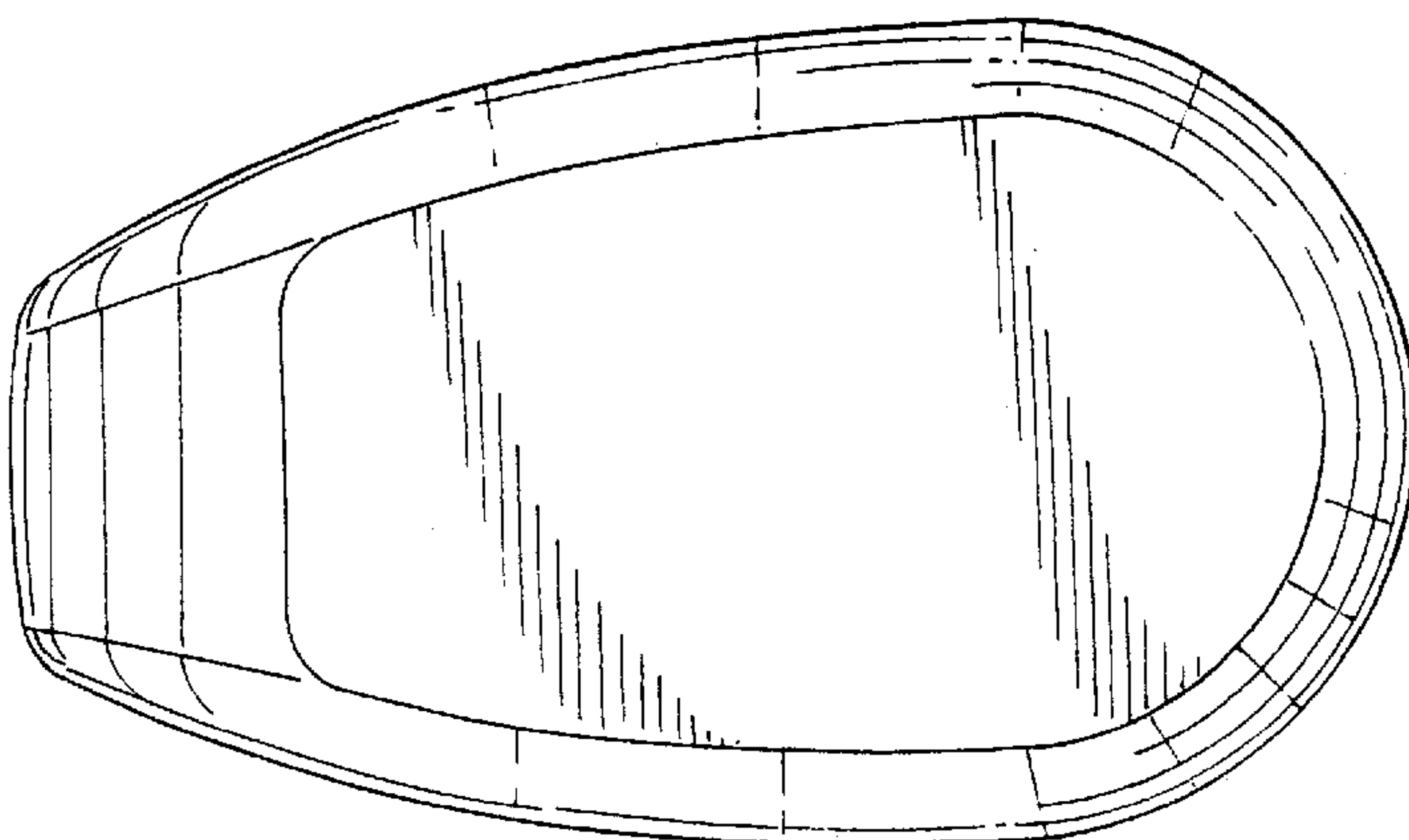

FIG. 6

FIG. 7

