



US00D415547S

United States Patent [19]

[11] **Patent Number: Des. 415,547**

Klima, Jr. et al.

[45] **Date of Patent: ** Oct. 19, 1999**

[54] **CONCENTRATE CARTRIDGE**

[75] Inventors: **Walter F. Klima, Jr.**, Travelers Rest, S.C.; **William L. Klima**, Spotsylvania, Va.

865,853	9/1907	Bailey	102/469
2,811,922	11/1957	Vaiden	102/469
3,675,576	7/1972	Whitney	102/469
5,157,219	10/1992	Calsson et al.	102/470

[73] Assignee: **Sprayex, Inc.**, Travelers Rest, S.C.

Primary Examiner—Doris Clark
Assistant Examiner—Monica A. Weingart
Attorney, Agent, or Firm—Klima & Pezzlo, P.C.

[**] Term: **14 Years**

[57] **CLAIM**

[21] Appl. No.: **29/086,410**

The ornamental design for a concentrate cartridge, as shown and described.

[22] Filed: **Apr. 13, 1998**

DESCRIPTION

[51] **LOC (6) Cl.** **22-03**

[52] **U.S. Cl.** **D22/116; D22/115**

[58] **Field of Search** **D22/115, 116; 102/469, 470**

FIG. 1 is a perspective view of the present invention.
FIG. 2 is a side elevational view.
FIG. 3 is a top planar view.
FIG. 4 is a bottom planar view.
FIG. 5 is a vertical cross-section view of the concentrate cartridge taken on line 5—5 of FIG. 3; and,
FIG. 6 is a center vertical cross-section view of the concentric cartridge taken along line 6—6 of FIG. 3.

[56] **References Cited**

U.S. PATENT DOCUMENTS

98,439	12/1869	Smith	102/470
D. 204,608	5/1966	Sobelewski	D22/116
855,958	6/1907	Loeble	102/470

1 Claim, 2 Drawing Sheets

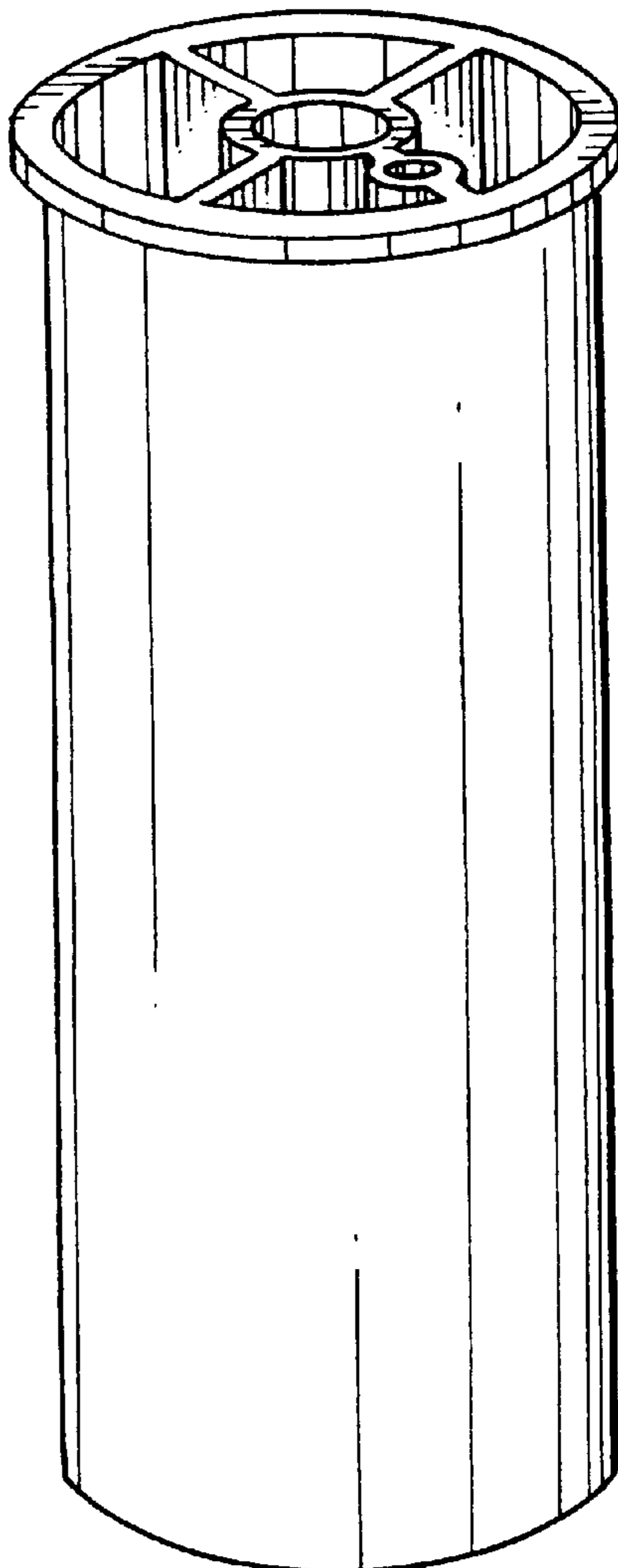

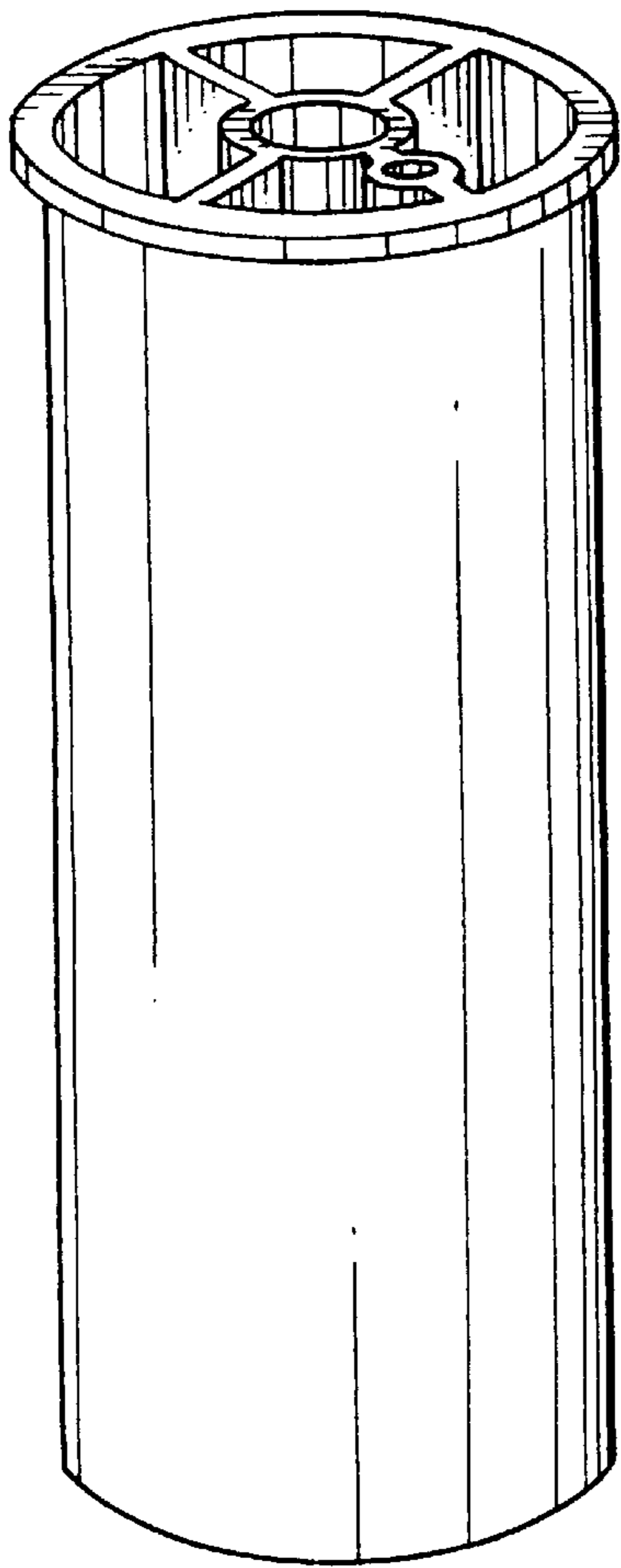

FIG. 1

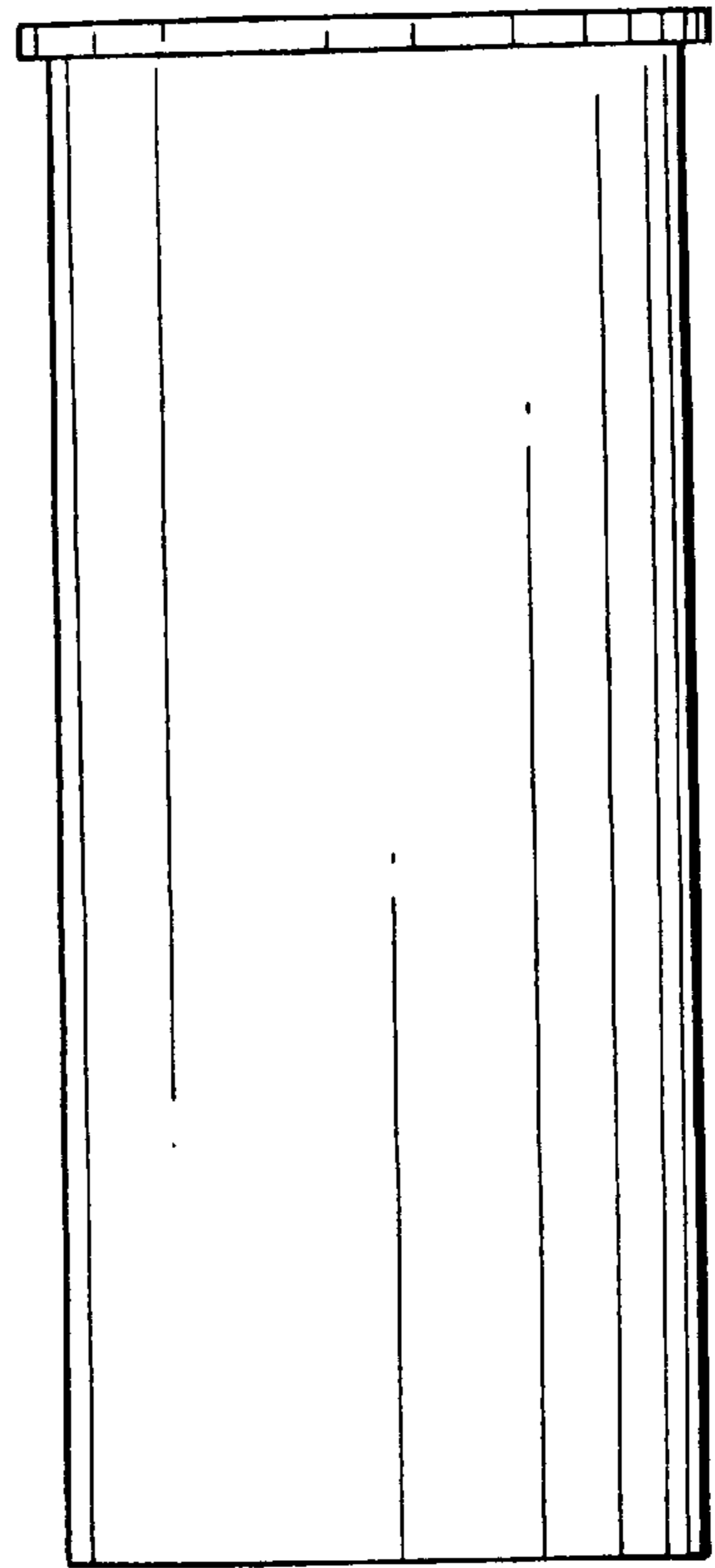

FIG. 2

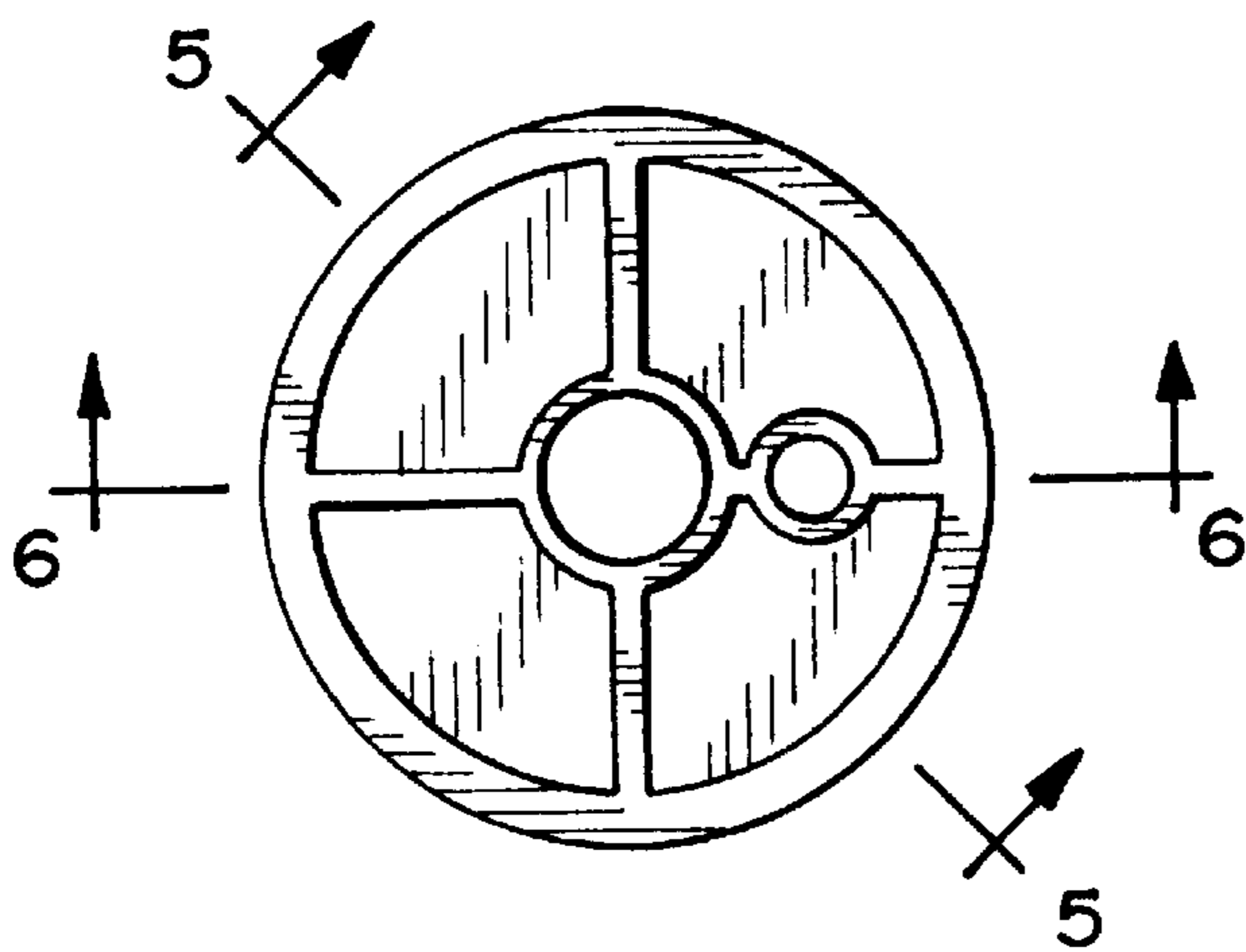

FIG. 3

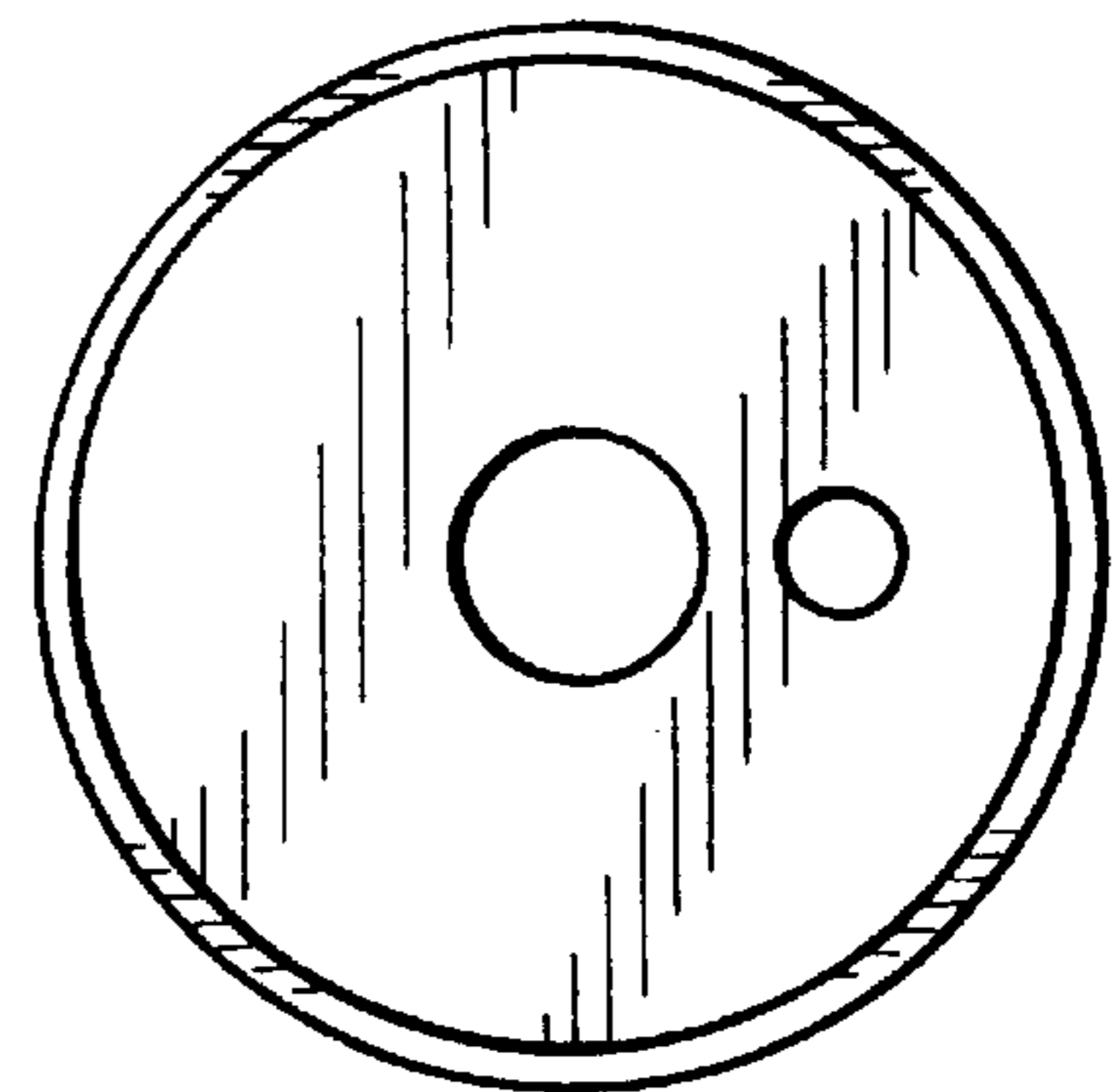

FIG. 4

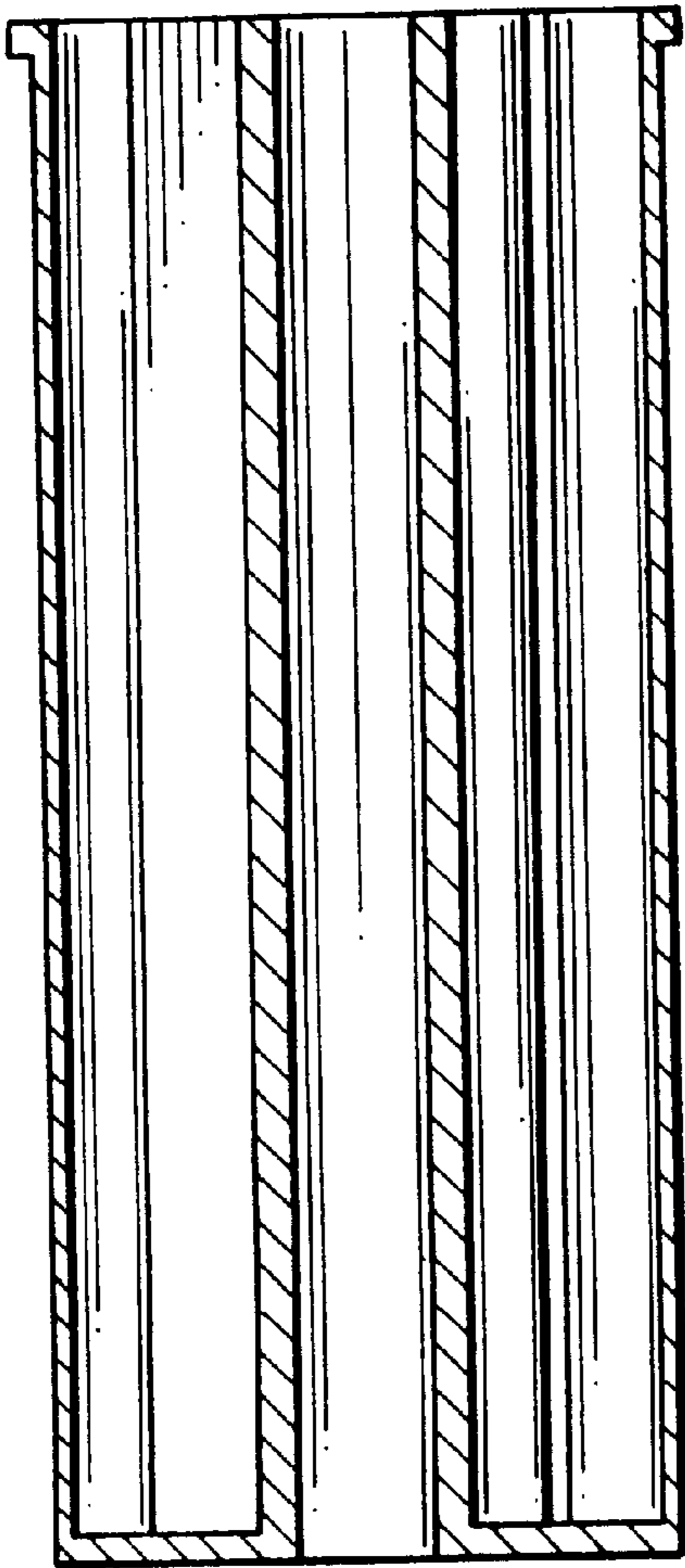

FIG. 5

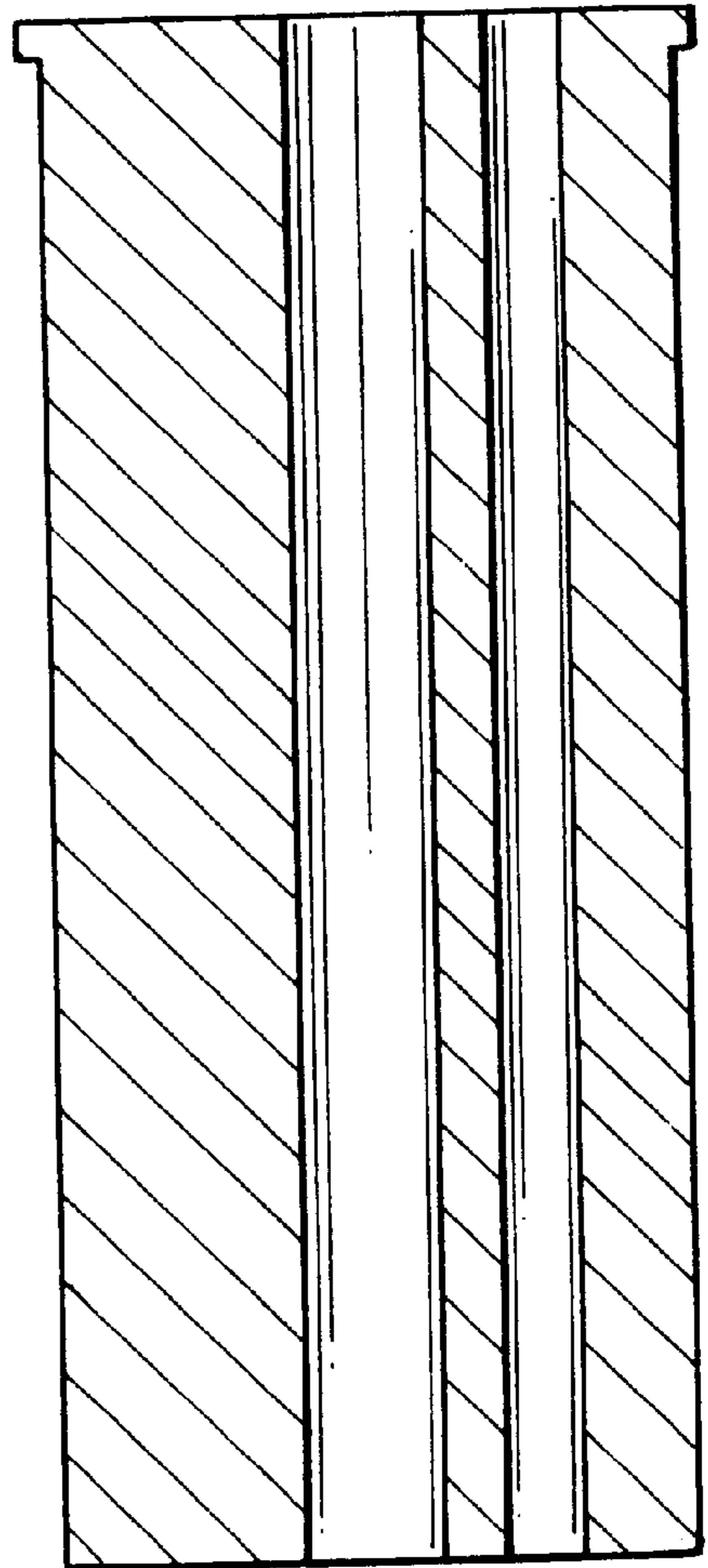

FIG. 6