



US00D415522S

United States Patent [19] Ostrander

[11] **Patent Number: Des. 415,522**

[45] **Date of Patent: ** Oct. 19, 1999**

[54] **BINDER LOCKING CLIP**

2,484,453 10/1949 Halverson 211/46
2,835,950 5/1958 Sonntag 402/23

[75] Inventor: **Jerry B. Ostrander**, St. Louis, Mo.

Primary Examiner—Martie K. Holtje

[73] Assignee: **U.S. Ring Binder Corp.**, New Bedford, Mass.

Attorney, Agent, or Firm—Polster, Lieder, Woodruff & Lucchesi, L.C.

[**] Term: **14 Years**

[57] CLAIM

[21] Appl. No.: **29/075,075**

The ornamental design for binder locking clip, as shown and described.

[22] Filed: **Aug. 12, 1997**

DESCRIPTION

[51] **LOC (6) Cl.** **19-04**

FIG. 1 is a front perspective view of a binder locking clip showing my new design;

[52] **U.S. Cl.** **D19/32; D19/65**

FIG. 2 is a left side elevational view;

[58] **Field of Search** 211/46; D19/26,

FIG. 3 is a right side elevational view;

D19/27, 32, 65, 99, 100; D8/343, 382,

FIG. 4 is a rear elevational view;

394, 395; 411/452, 920, 923; 402/2, 6,

FIG. 5 is a front elevational view;

4, 19, 20-26, 27, 70, 31, 73, 46-48, 74,

FIG. 6 is a bottom plan view;

64, 75, 80 R; 24/67.1-67.9, 555, 67.11,

FIG. 7 is a top plan view;

67 R, 265 A, 2, 543, 546, 563, 710.5, DIG. 8,

FIG. 8 is a second front elevational view;

119; 40/666; 281/2, 6, 15.1, 21.1, 27.1-28

FIG. 9 is a second left side elevational view;

[56] References Cited

FIG. 10 is a left side elevational view of a second embodiment of my design of FIG. 1;

U.S. PATENT DOCUMENTS

FIG. 11 is a right side elevational view of FIG. 10;

461,143 10/1891 Randall 24/546 X

FIG. 12 is a front elevational view of FIG. 10;

498,664 5/1893 Leathers 24/710.5

FIG. 13 is a rear elevational view of FIG. 10; and,

843,960 2/1907 McCallum 24/265 A

FIG. 14 is a top plan view of FIG. 10.

1,019,256 3/1912 Irvin 24/555

The binding structure depicted by means of broken lines in

1,245,936 11/1917 Loveland 24/67.9

FIGS. 1, 8 and 9 has been shown for illustrative purposes

1,488,594 4/1924 Gaschke 24/543

only and forms no part of the claimed design.

1,653,465 12/1927 Montan et al. 24/710.5

1 Claim, 2 Drawing Sheets

2,111,845 3/1938 Dunham 402/4

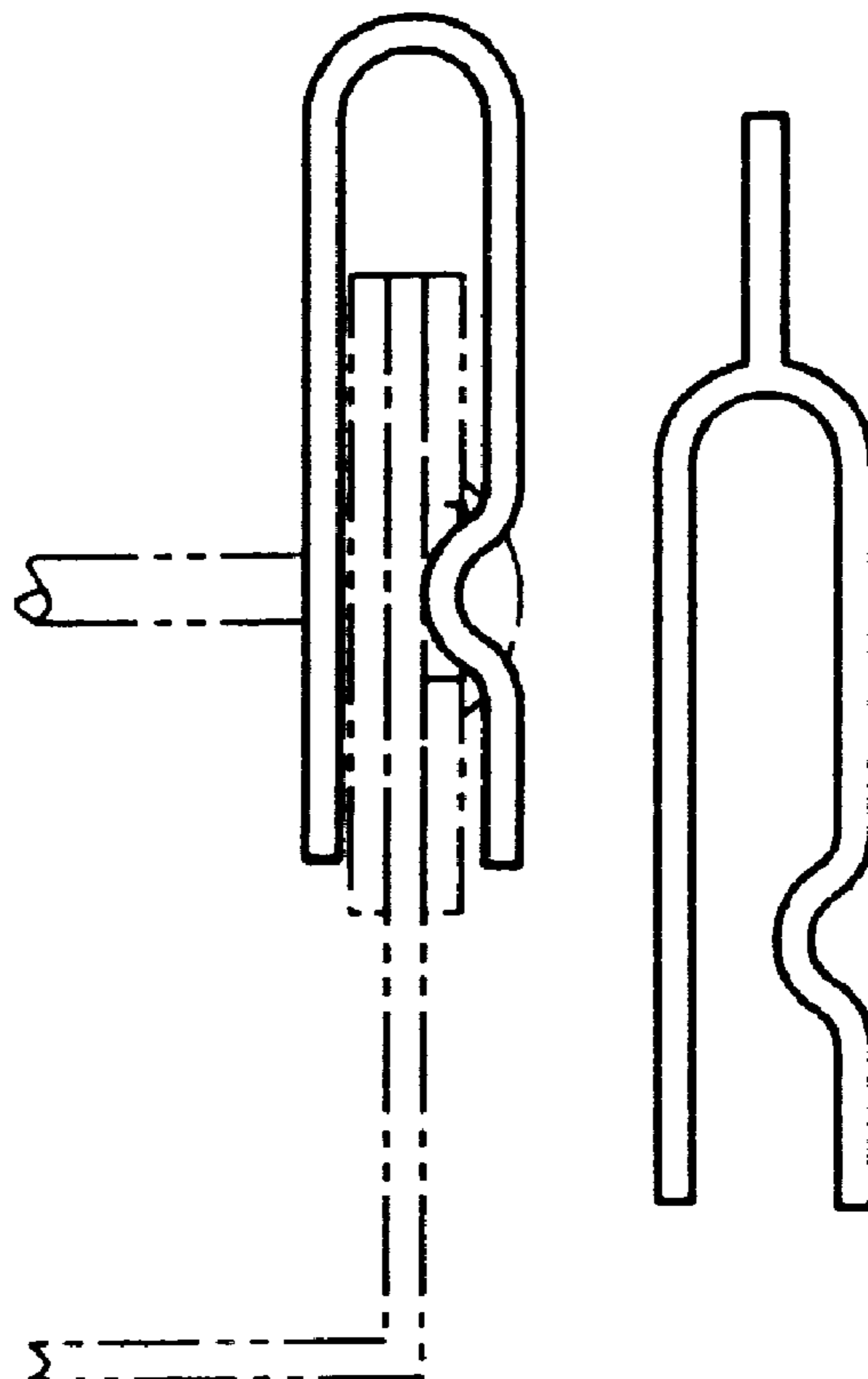

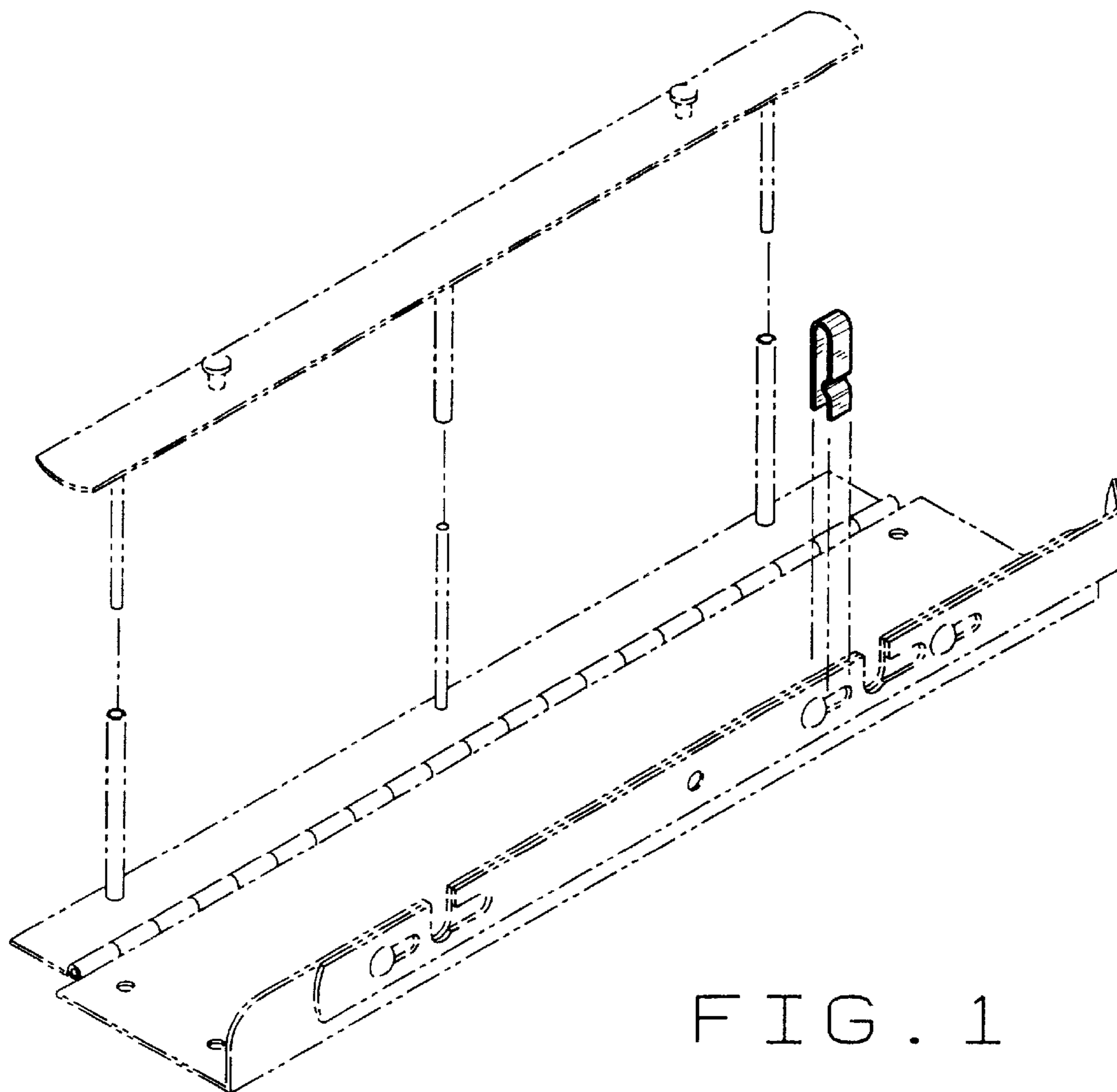

FIG. 1

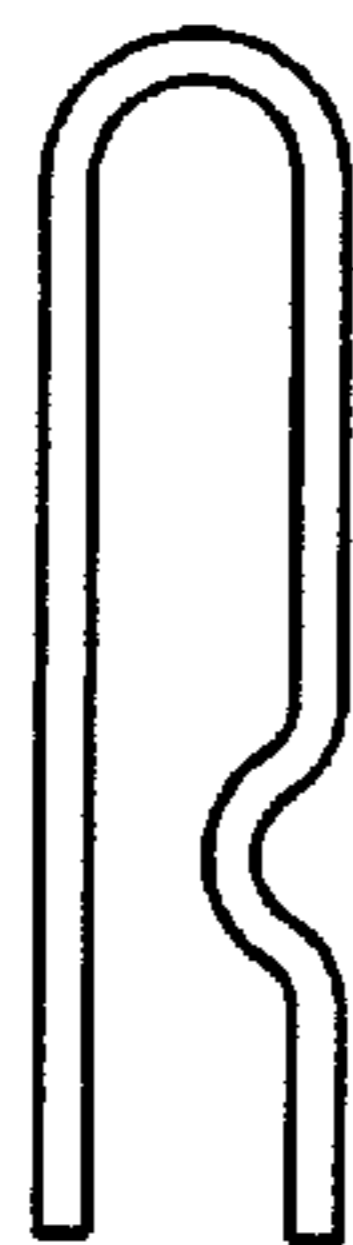

FIG. 2

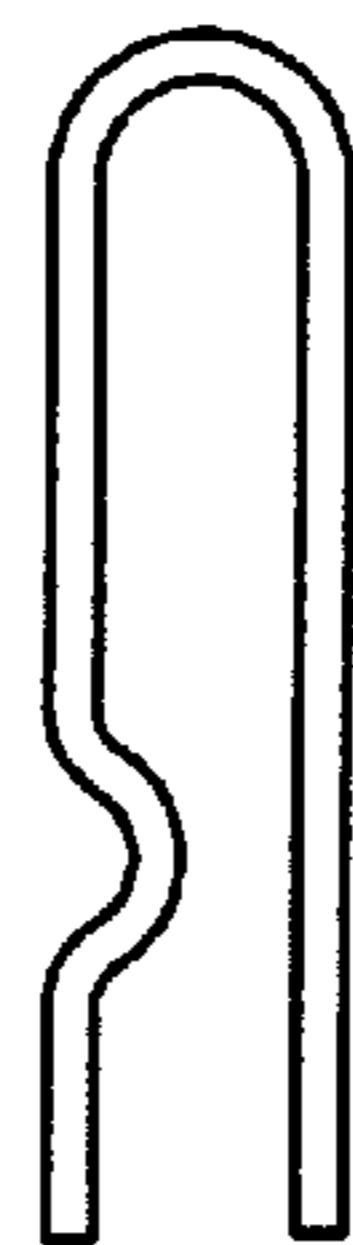

FIG. 3

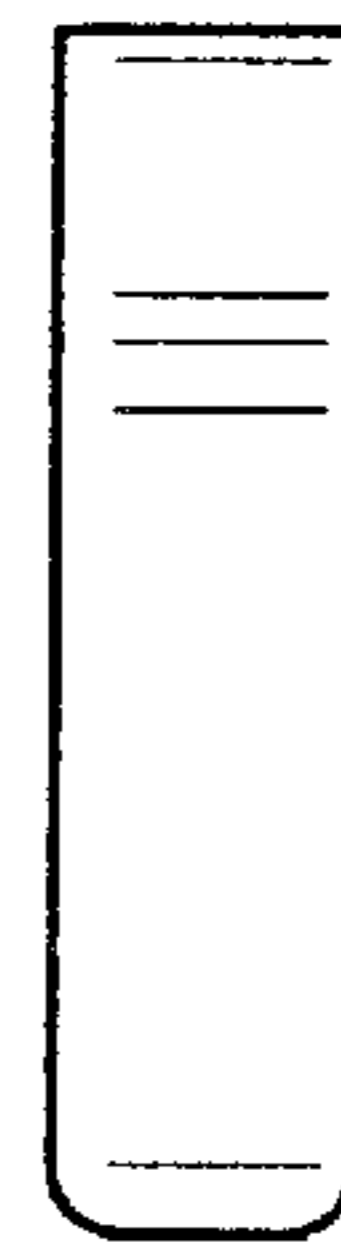

FIG. 4

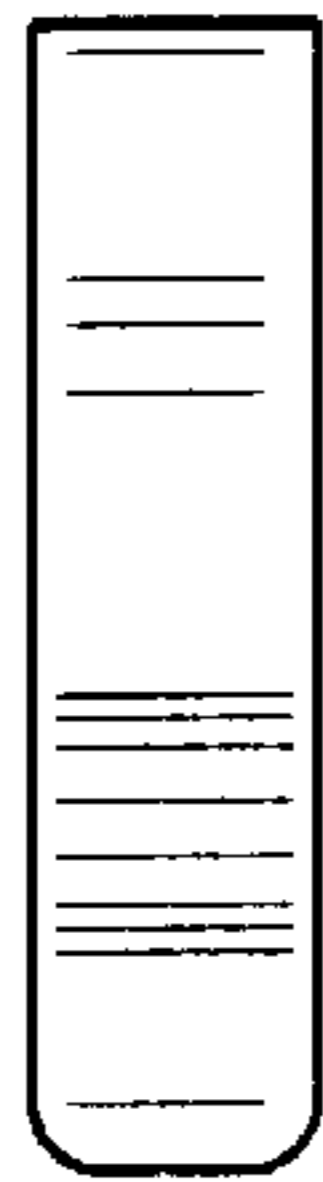

FIG. 5



FIG. 6



FIG. 7

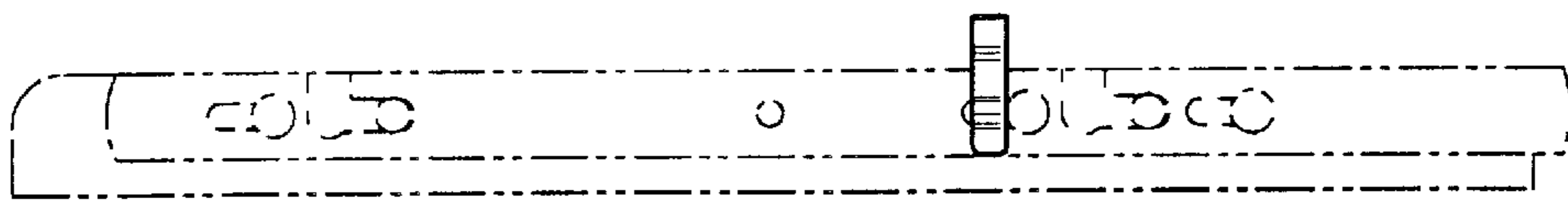

FIG. 8

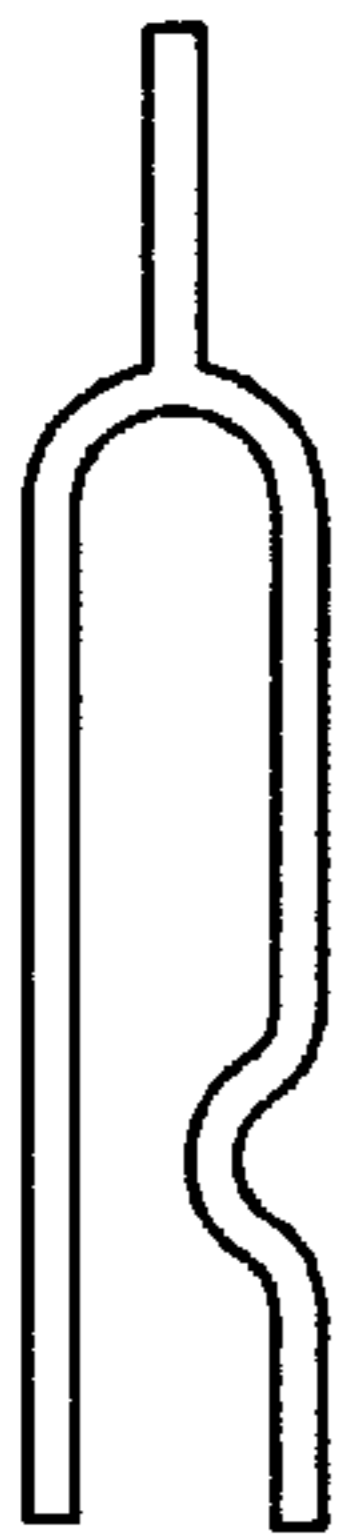

FIG. 10

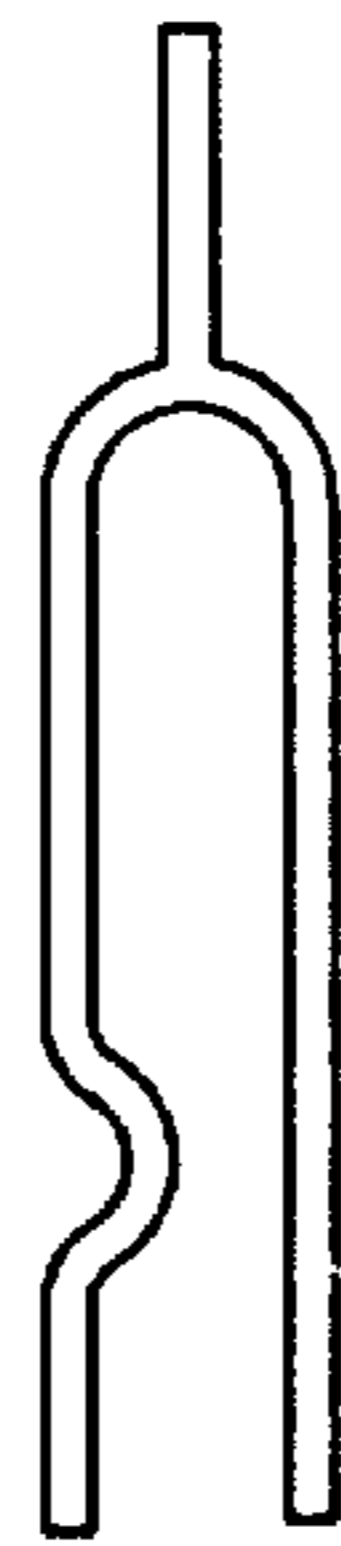

FIG. 11



FIG. 12

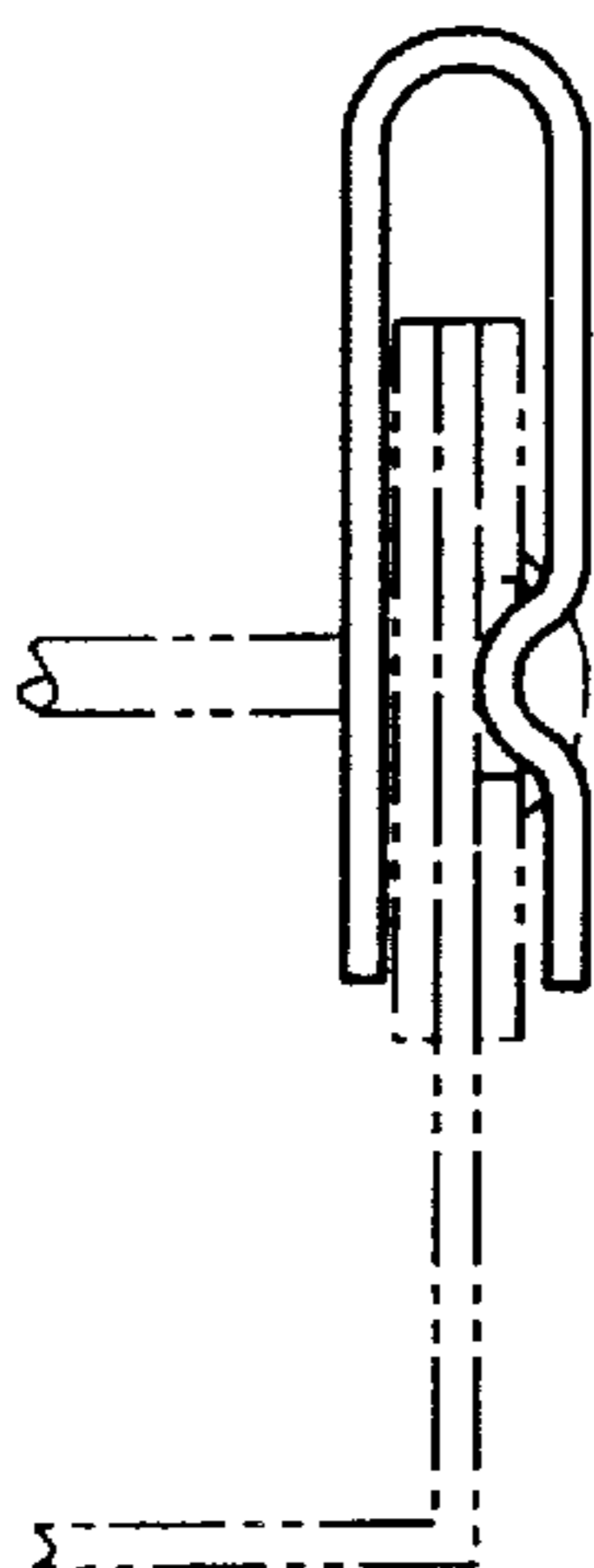

FIG. 9

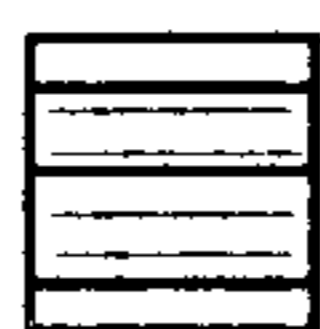

FIG. 13

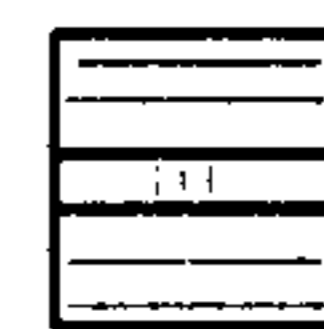

FIG. 14