



US00D415491S

# United States Patent [19]

Yano et al.

[11] Patent Number: **Des. 415,491**

[45] Date of Patent: **\*\* Oct. 19, 1999**

[54] **COMBINED DISC PLAYER AND RADIO RECEIVER**

5,459,702 10/1995 Greenspan ..... D14/188 X

[75] Inventors: **Ken Yano; Akira Yamazaki**, both of Tokyo, Japan

[73] Assignee: **Sony Corporation**, Tokyo, Japan

[\*\*] Term: **14 Years**

[21] Appl. No.: **29/093,296**

[22] Filed: **Sep. 8, 1998**

[30] **Foreign Application Priority Data**

Mar. 6, 1998 [JP] Japan ..... 10-6280

[51] **LOC (6) Cl.** ..... **14-01**

[52] **U.S. Cl.** ..... **D14/168; D14/156; D14/197**

[58] **Field of Search** ..... D14/124, 135-136, D14/156-157, 162, 164, 168, 193-198, 239, 257-260, 265, 299; 312/7.1; 455/6.1, 344, 347, 350, 351

[56] **References Cited**

**U.S. PATENT DOCUMENTS**

- D. 328,747 8/1992 Ito et al. .... D14/188
- D. 351,167 10/1994 Yun ..... D14/156
- D. 367,275 2/1996 Ito et al. .... D14/188
- D. 372,915 8/1996 Ito et al. .... D14/188

**OTHER PUBLICATIONS**

Sony Catalog, "88", p. 176, (Mar., 1998).

*Primary Examiner*—Nanda Bondade  
*Attorney, Agent, or Firm*—Foley & Lardner

[57] **CLAIM**

The ornamental design for a combined disc player and radio receiver, as shown and described.

**DESCRIPTION**

FIG. 1 is a perspective view of a combined disc player and radio receiver showing our new design; FIG. 2 is a top plan view thereof; FIG. 3 is a left side elevational view thereof; FIG. 4 is a front elevational view thereof; FIG. 5 is a bottom plan view thereof; FIG. 6 is a right side elevational view thereof; and FIG. 7 is a rear elevational view thereof; and, FIG. 8 is a perspective view thereof, wherein the panel portion is in the open position; the undisclosed inside portions of the combined disc player and radio receiver form no part of the claimed design.

The broken line showing of the inside of the combined disc and radio receiver is for illustrative purposes only and forms no part of the claimed design.

**1 Claim, 5 Drawing Sheets**

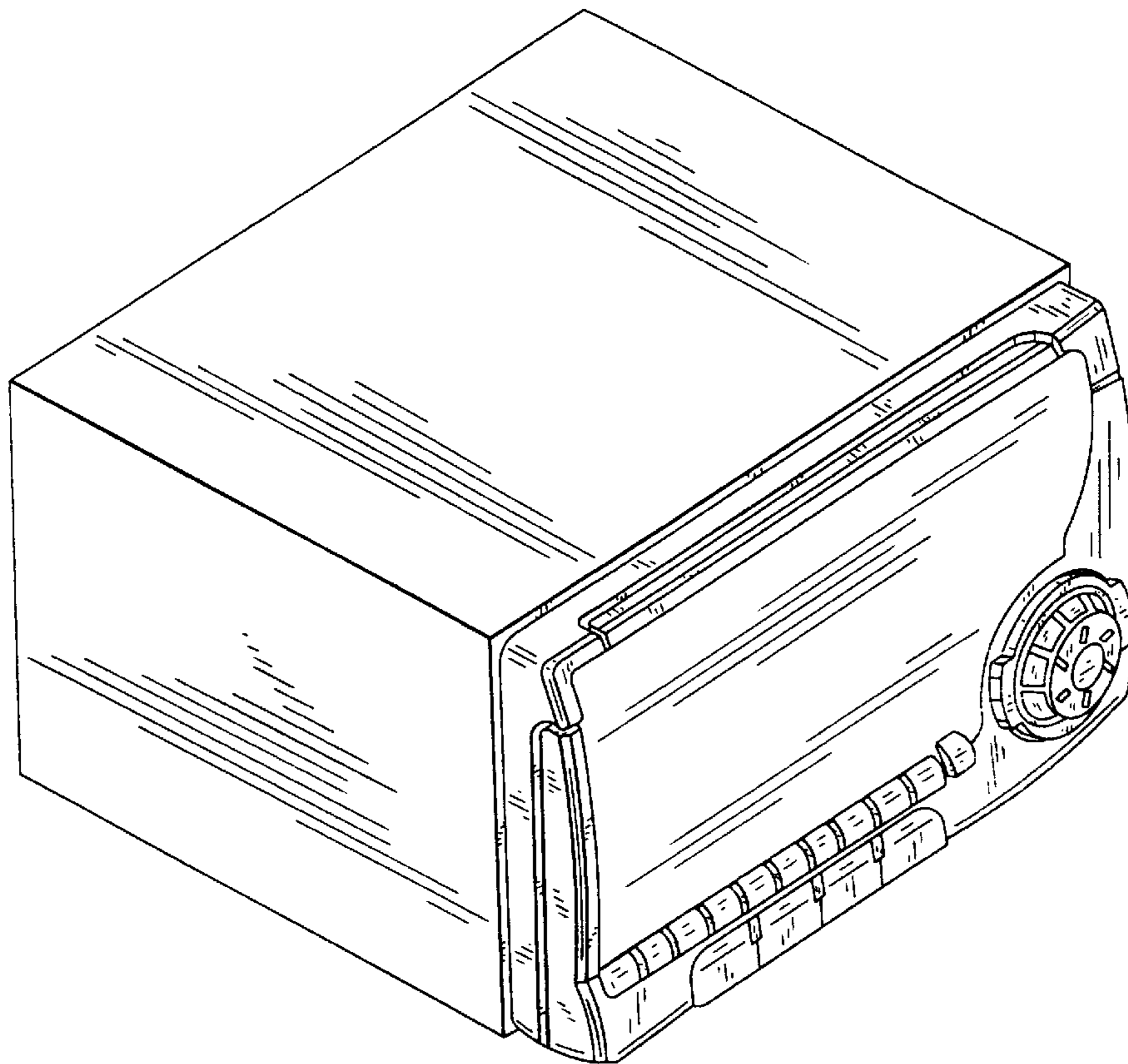

FIG. 1

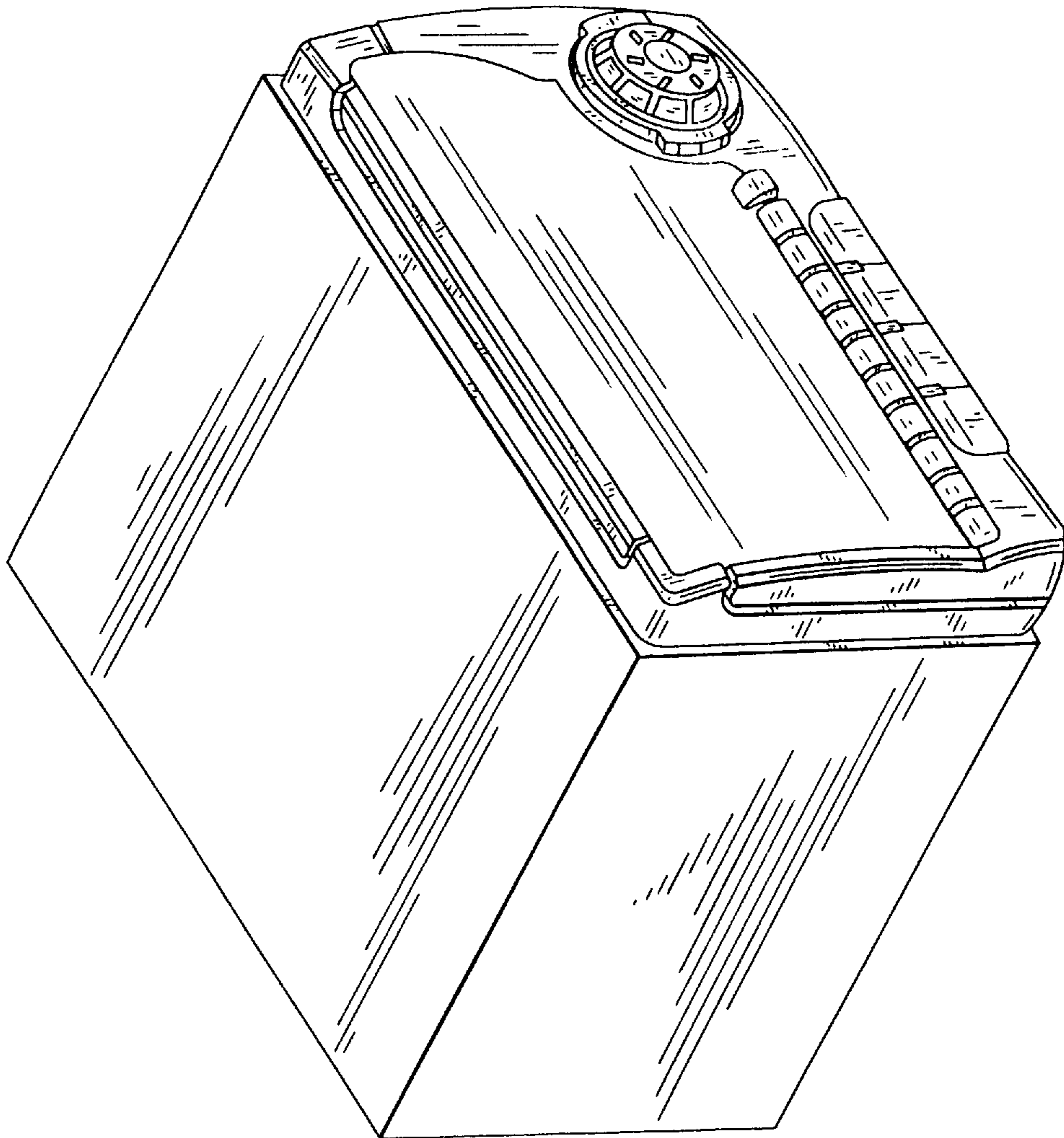

FIG. 2

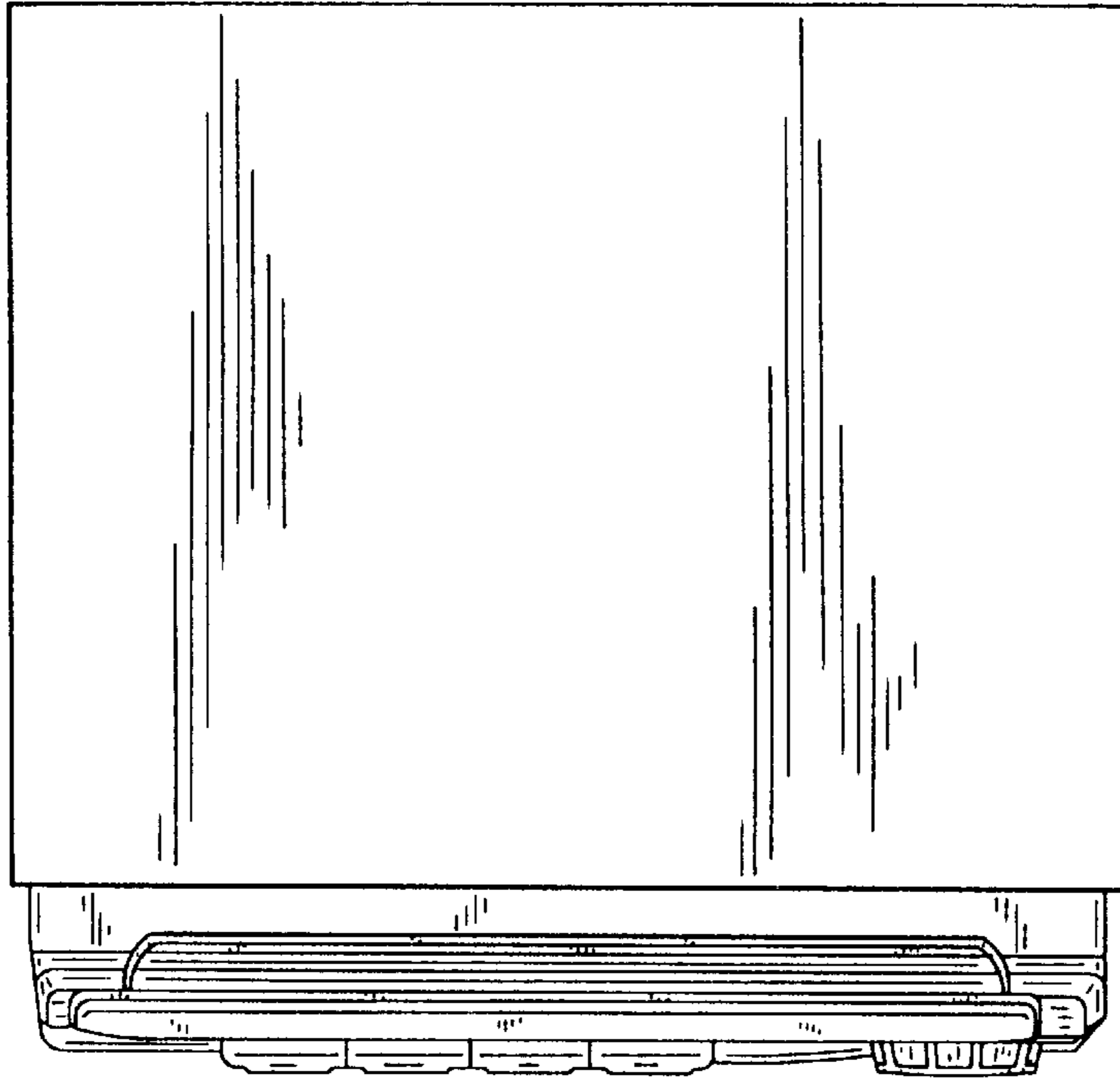

FIG. 5

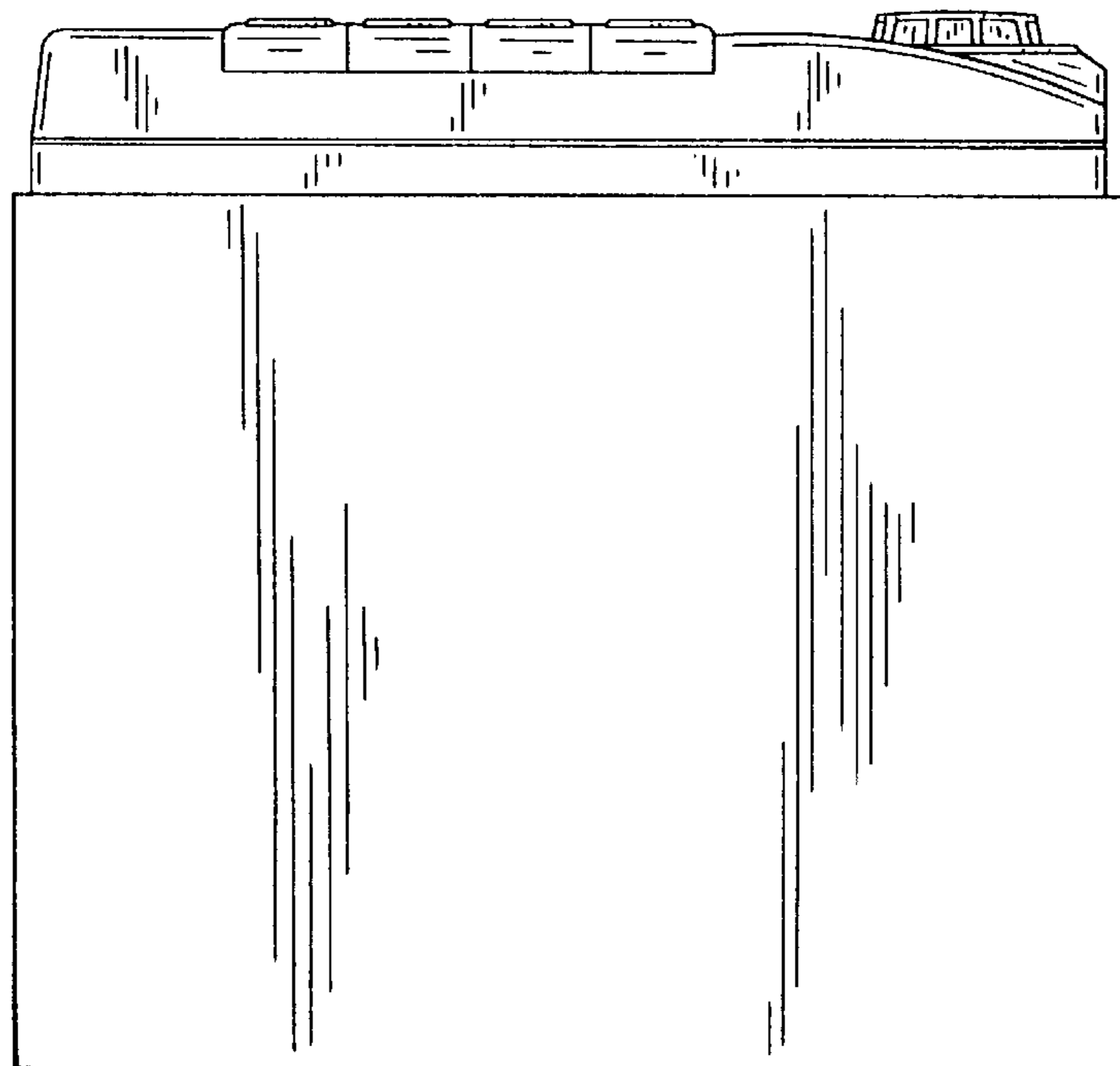

FIG. 3

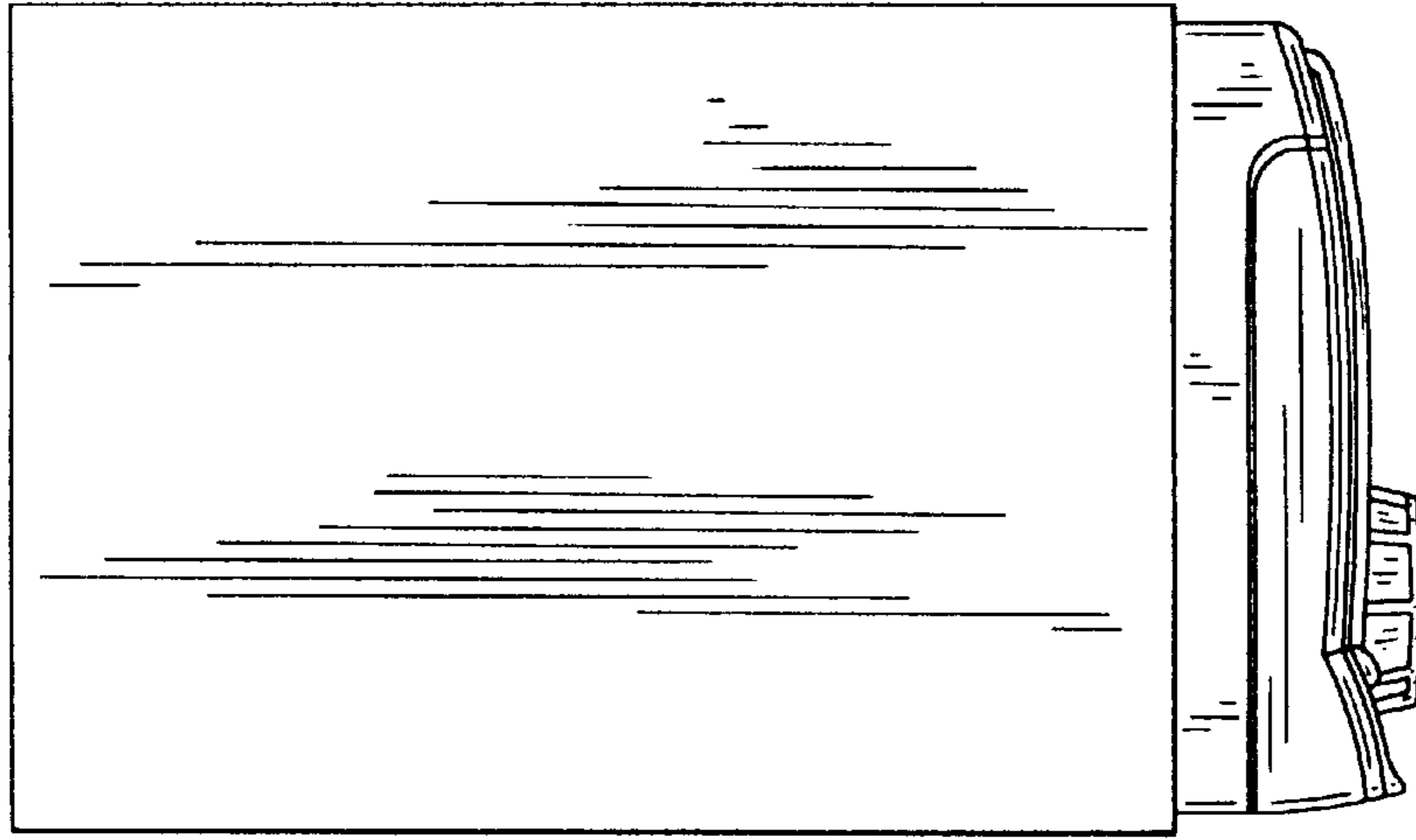

FIG. 4

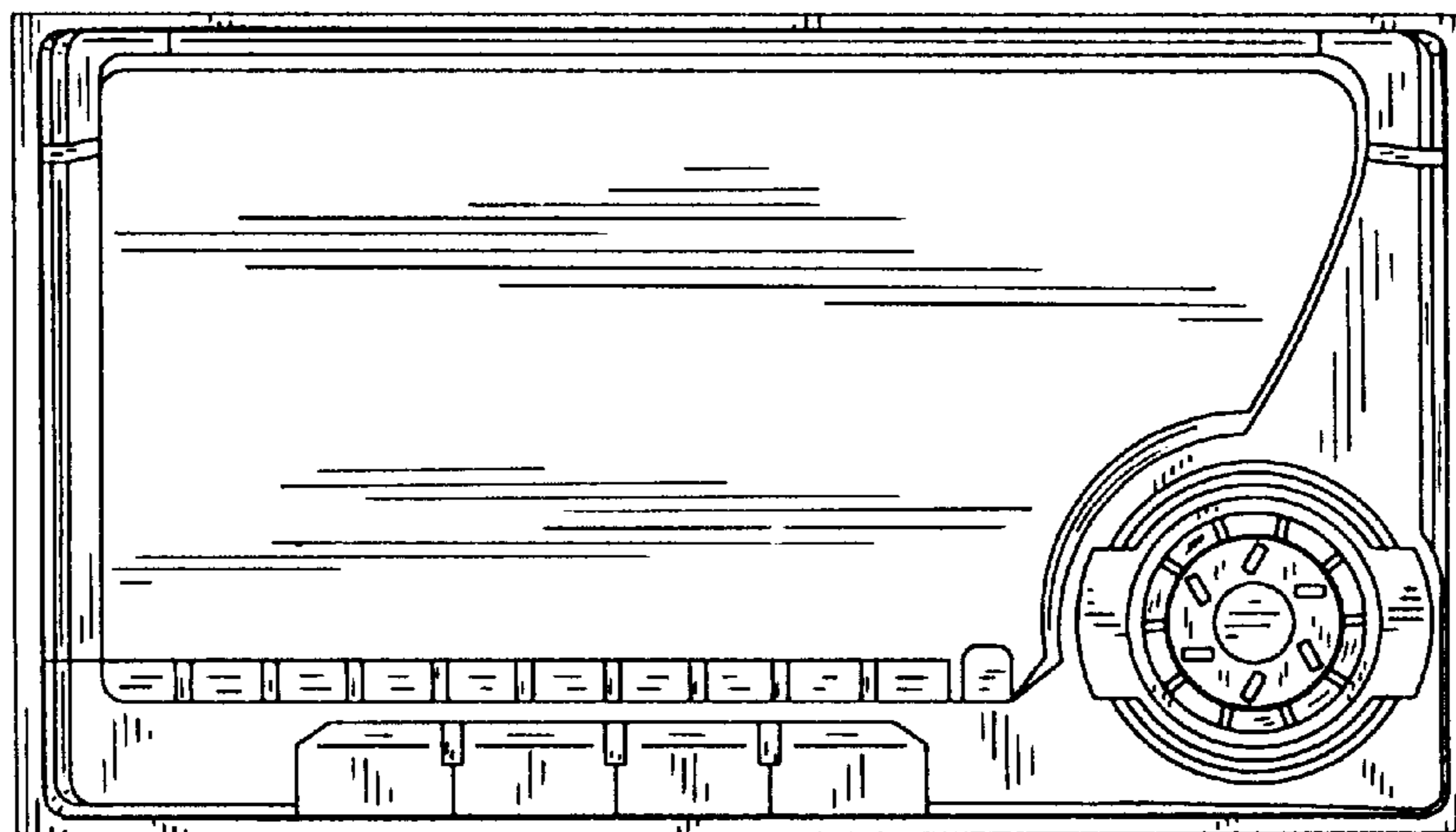

FIG. 6

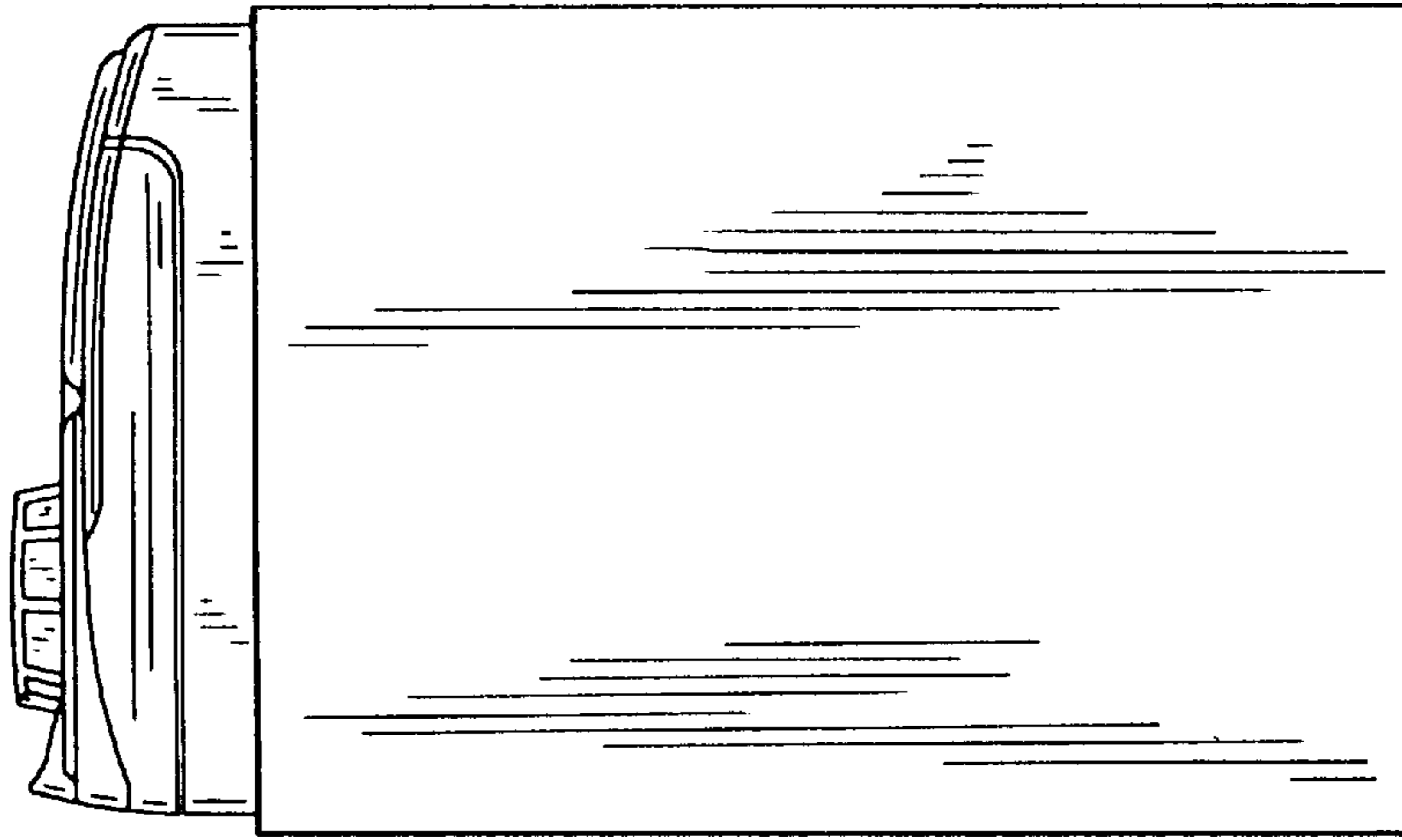

FIG. 7

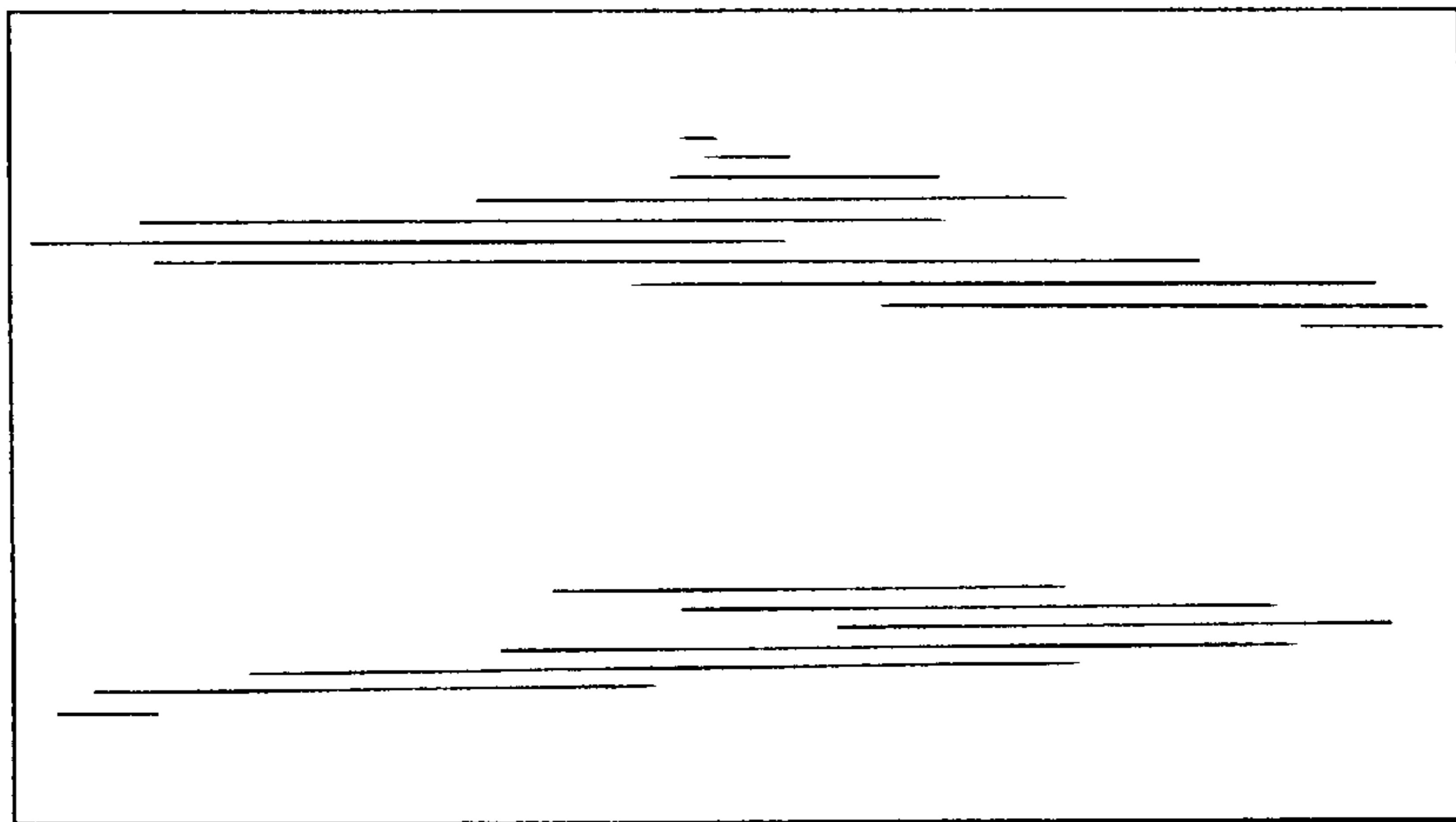

FIG. 8

