



US00D415365S

United States Patent [19] Nicklas

[11] **Patent Number: Des. 415,365**

[45] **Date of Patent: ** Oct. 19, 1999**

[54] **LARGE WORKSHOP TABLE**

[75] Inventor: **Mike Nicklas**, Luneburg, Germany

[73] Assignee: **Knürr-Mechanik für die Elektronik
Aktiengesellschaft**, München, Germany

[**] Term: **14 Years**

[21] Appl. No.: **29/071,693**

[22] Filed: **Jun. 4, 1997**

[30] **Foreign Application Priority Data**

Dec. 5, 1996 [DE] Germany M96 10 561

[51] **LOC (6) Cl.** **06-04**

[52] **U.S. Cl.** **D6/400**

[58] **Field of Search** D6/396-397, 399,
D6/400, 422-428, 474, 480, 484; 144/285,
286.1, 286.5

[56] **References Cited**

U.S. PATENT DOCUMENTS

- D. 170,329 9/1953 Miller D6/397 X
- D. 175,543 9/1955 Godden D6/397

- D. 215,162 9/1969 Robichand D6/399
- D. 343,534 1/1994 Holsapple D6/436
- D. 348,573 7/1994 Ewald D6/400
- D. 379,724 6/1997 Lo D6/436
- 1,459,930 6/1923 Riehle 144/285
- 1,582,100 4/1926 Troppman 144/286.5
- 4,161,974 7/1979 Patterson 144/286.1 X

Primary Examiner—Carmen H. Vales-Lado
Attorney, Agent, or Firm—Evenson, McKeown, Edwards & Lenahan, PLLC

[57] **CLAIM**

The ornamental design for a large workshop table, as shown and described.

DESCRIPTION

FIG. 1 is a front, top and side perspective view of a large workshop table showing my new design; FIG. 2 is a front elevational view thereof; FIG. 3 is a top plan view thereof; FIG. 4 is a bottom plan view thereof; FIG. 5 is a right side elevational view thereof, the left side elevational view being a mirror image thereof; and, FIG. 6 is a rear elevational view thereof.

1 Claim, 3 Drawing Sheets

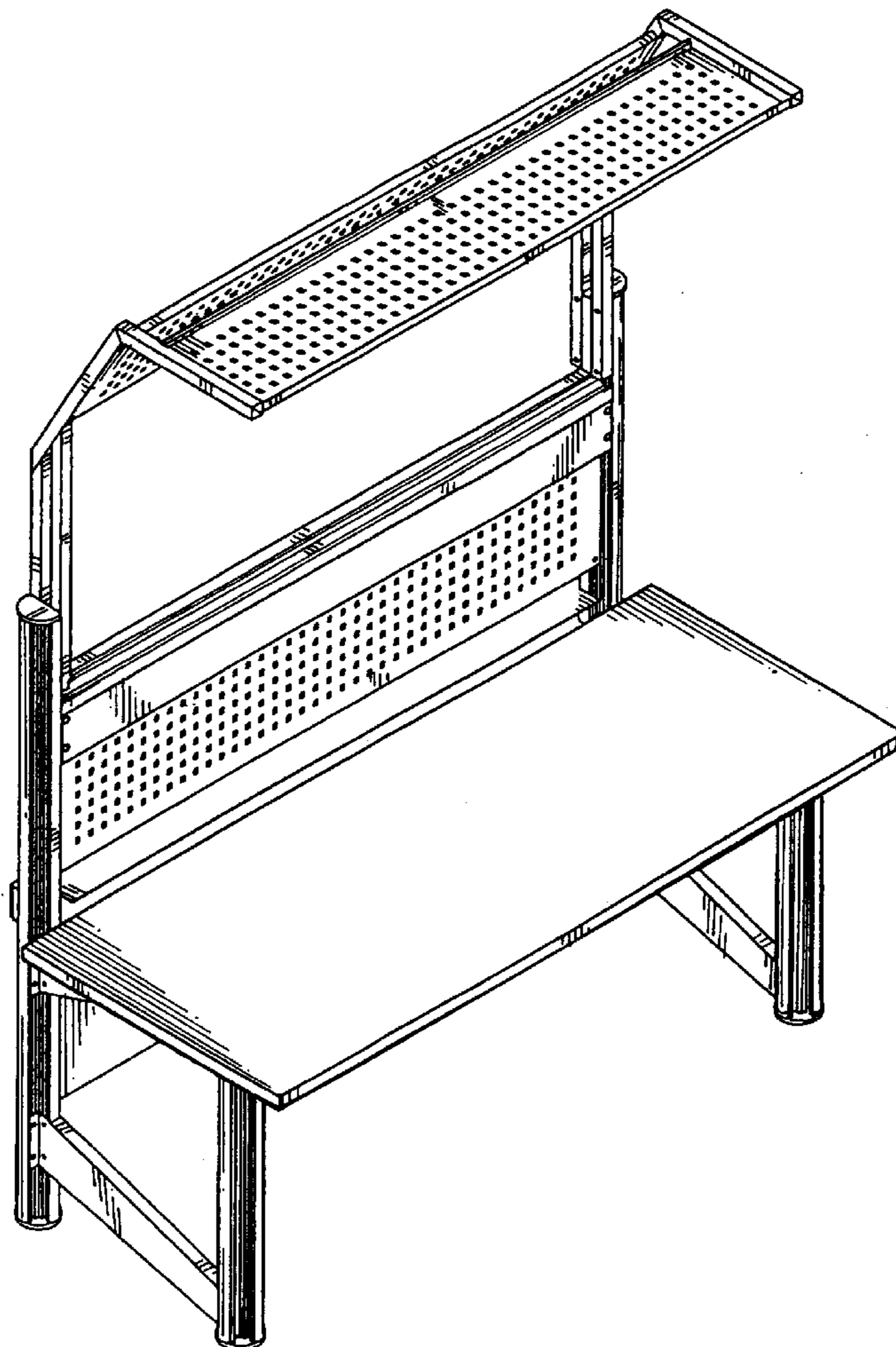

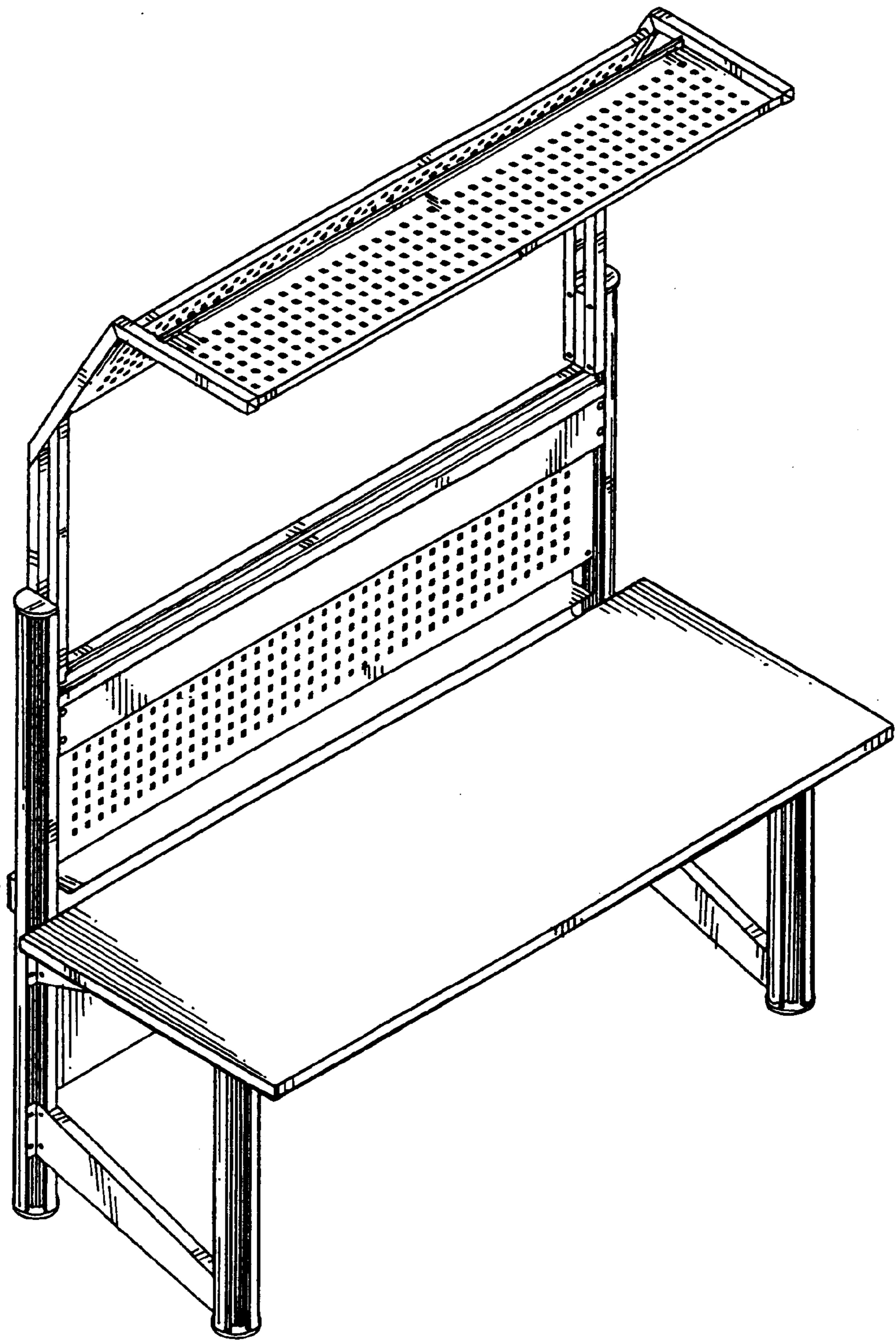

Fig. 1

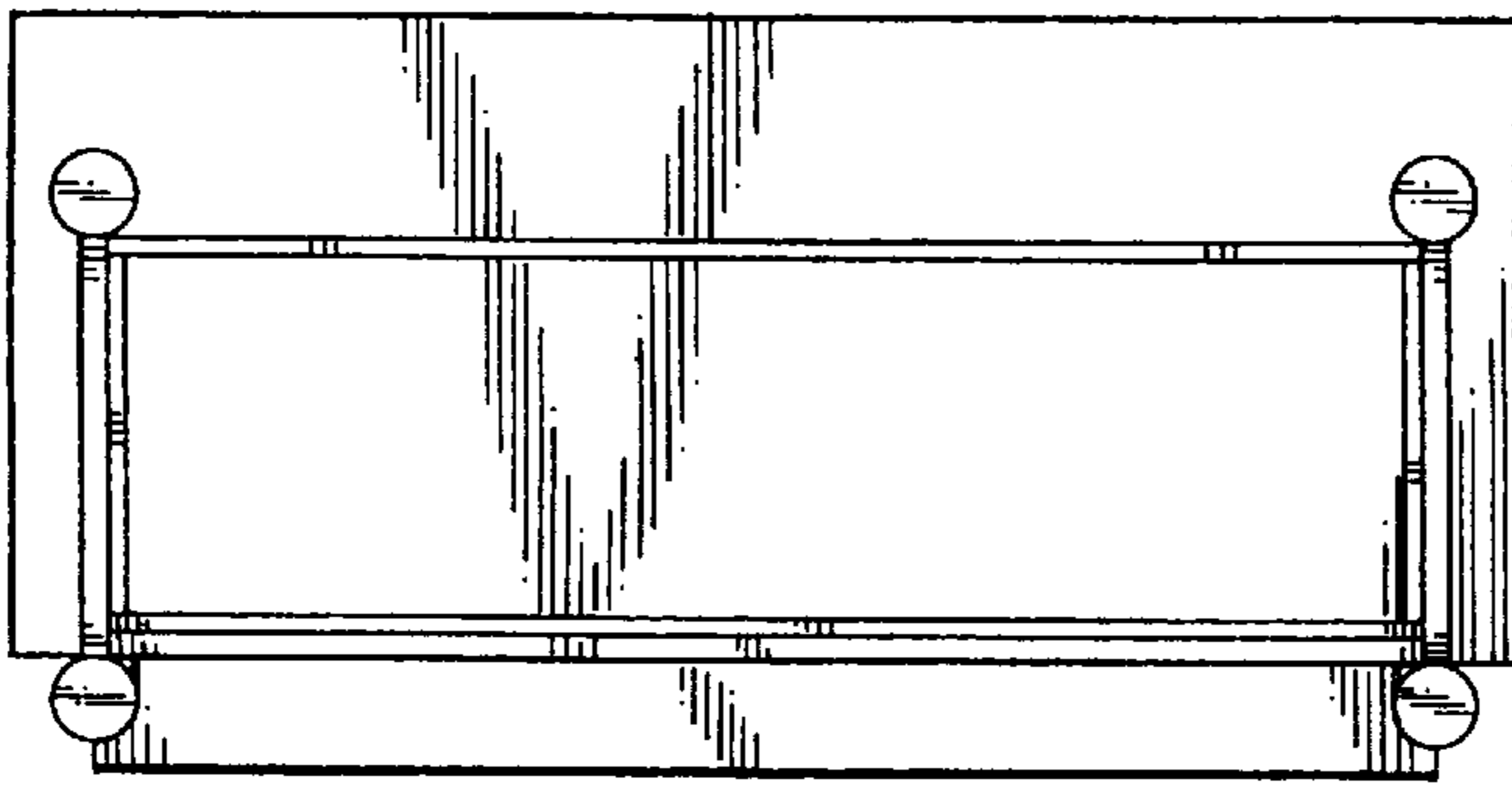

Fig. 4

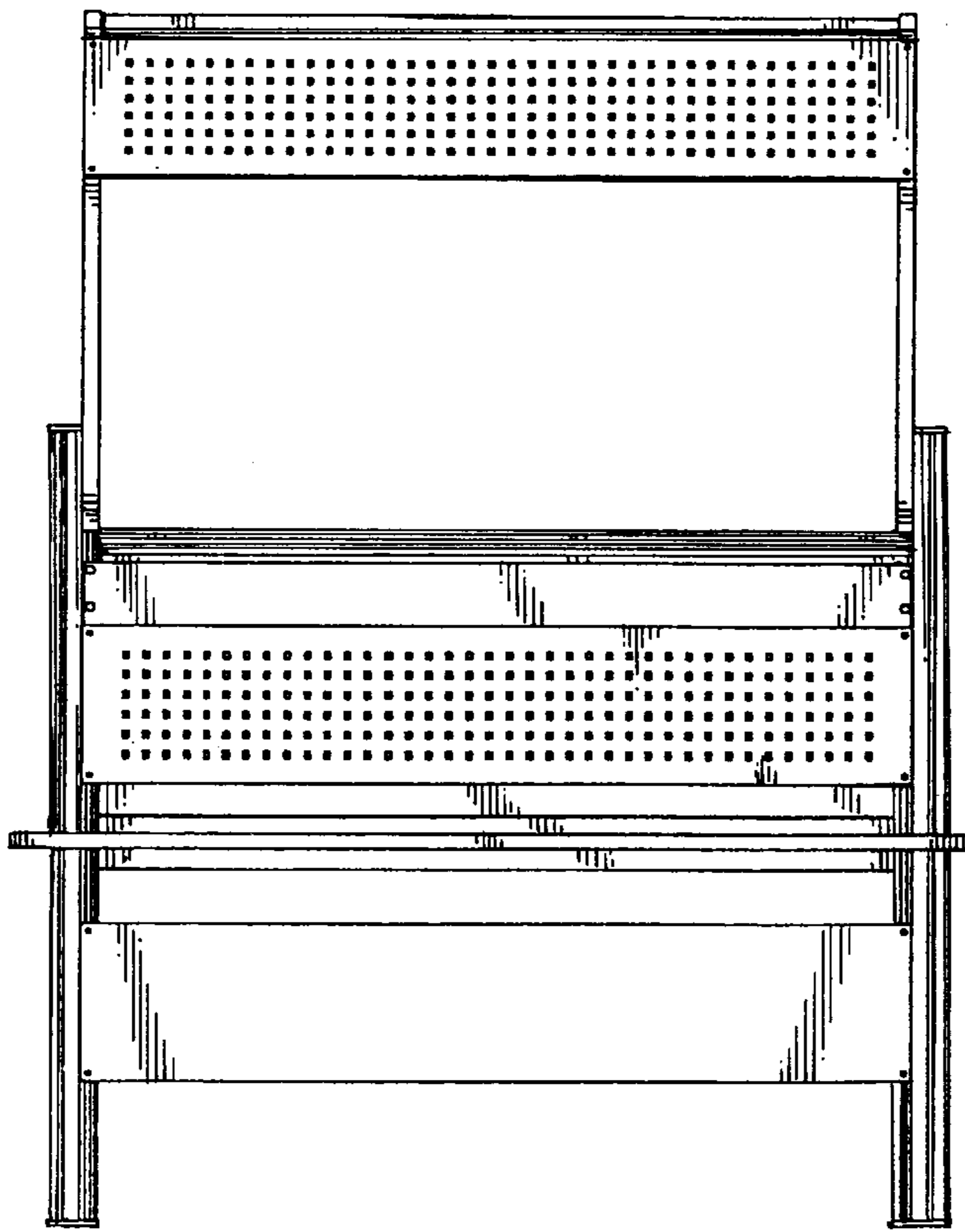

Fig. 2

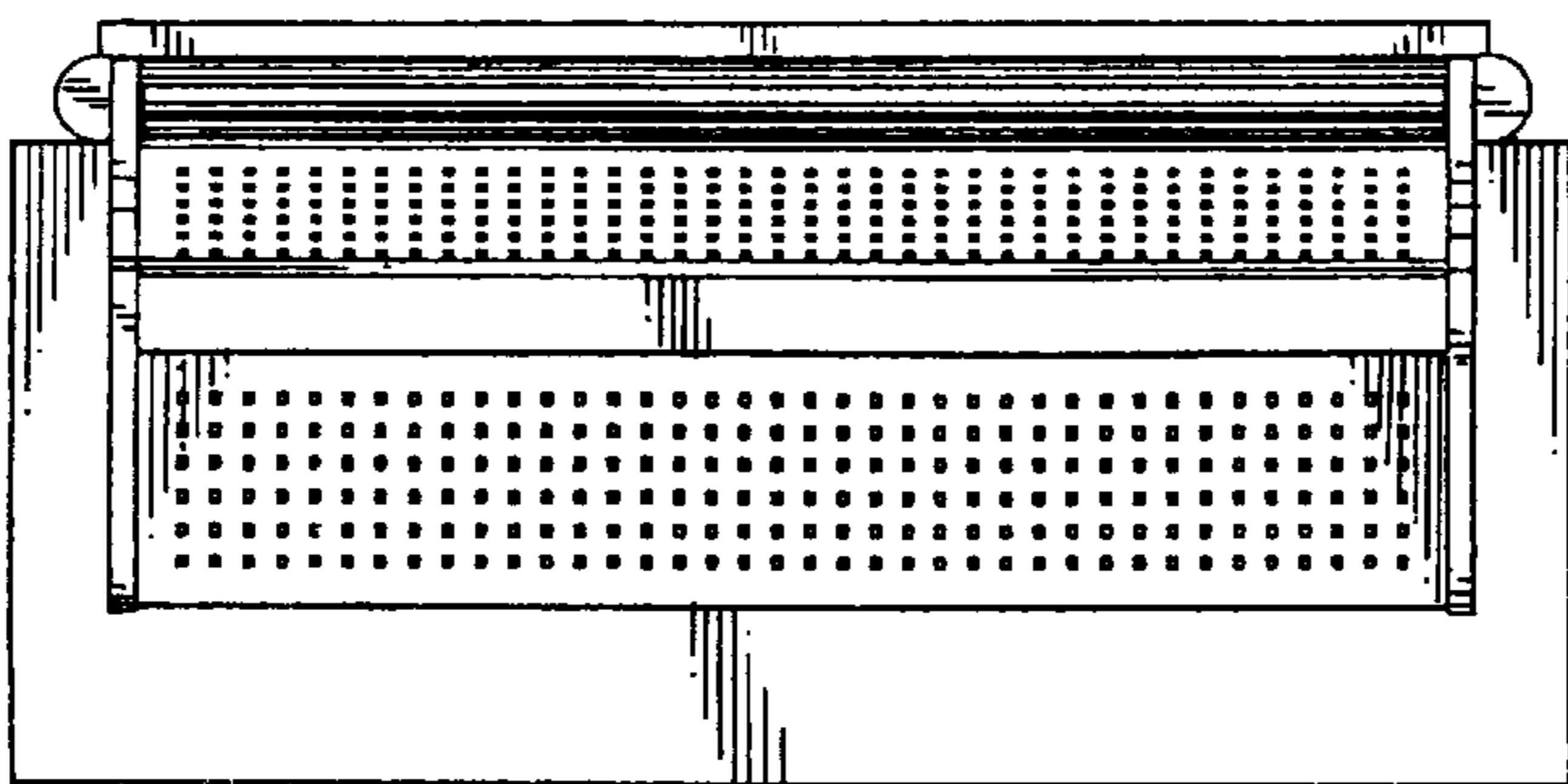

Fig. 3

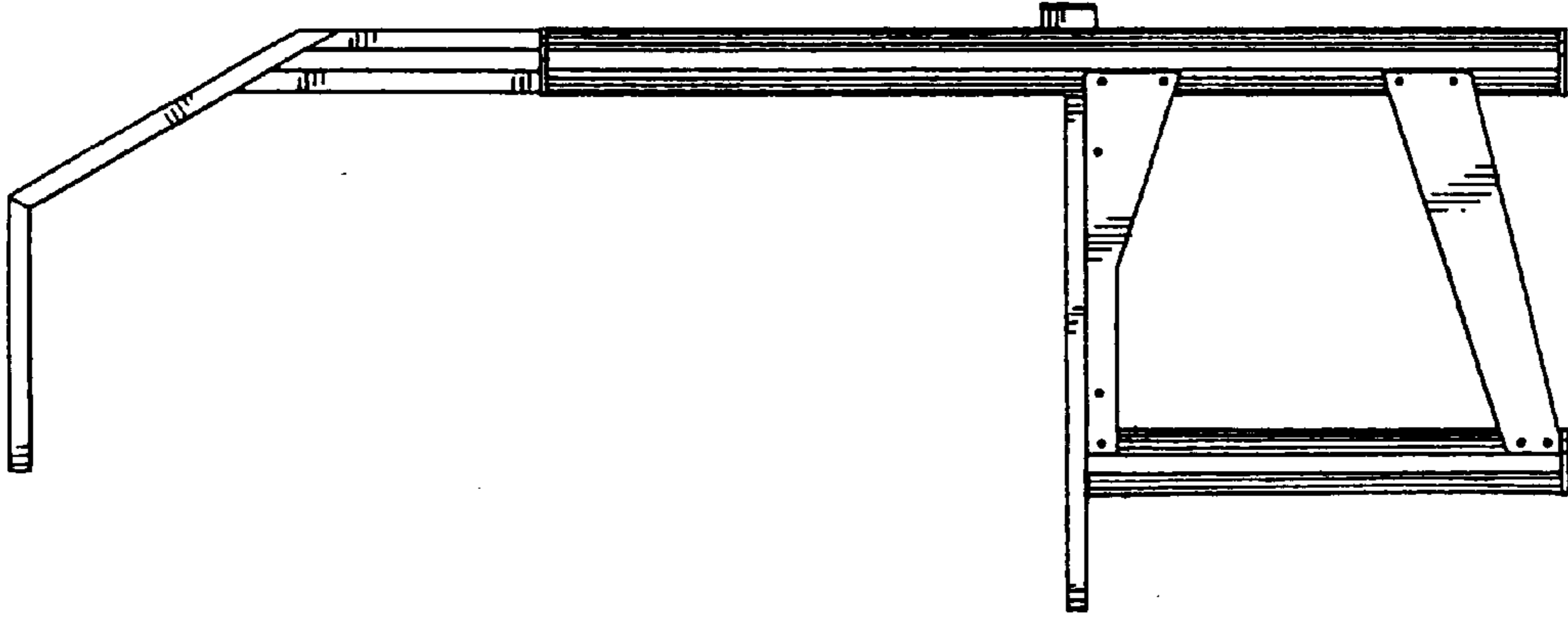

Fig. 5

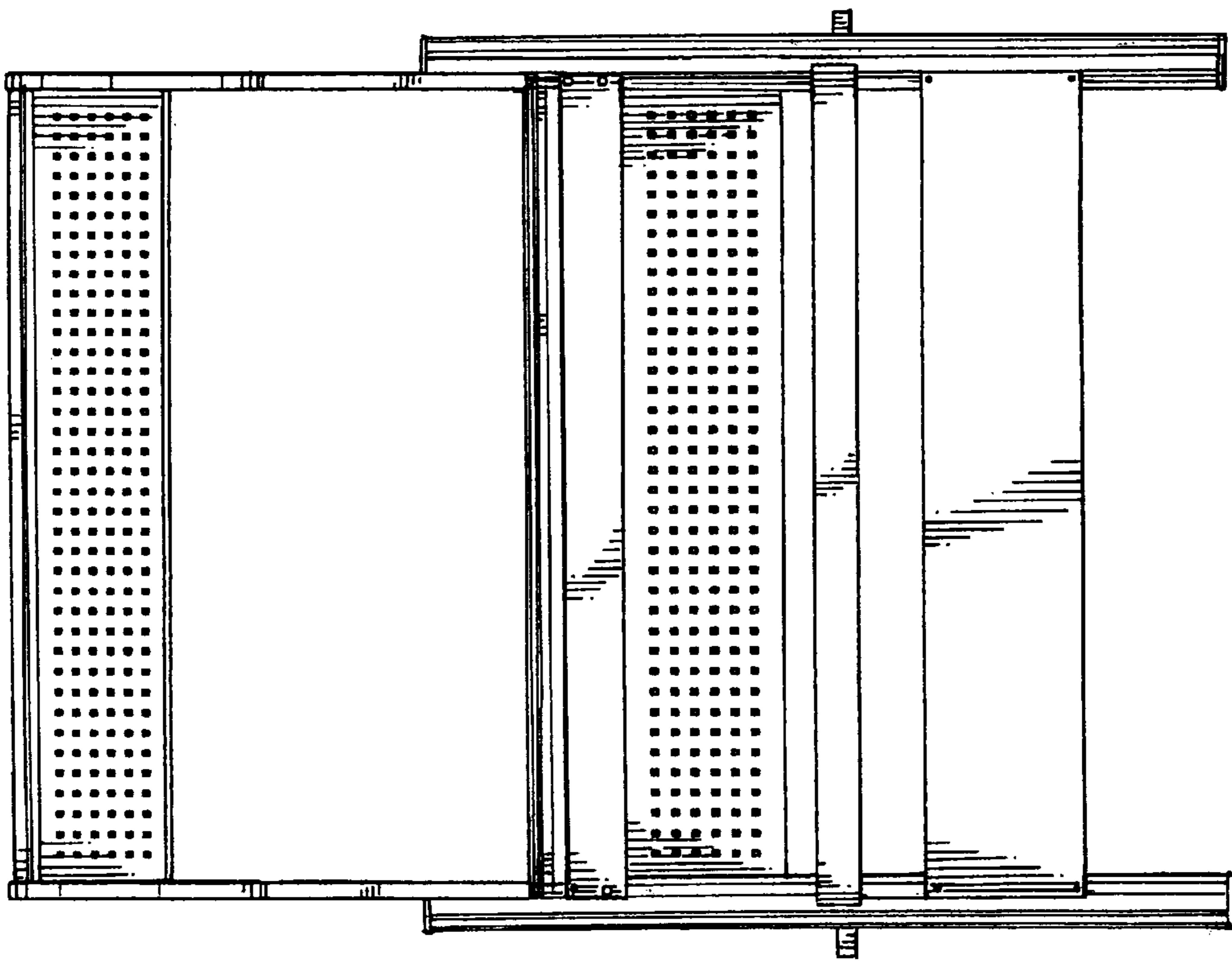

Fig. 6