



US00D414981S

United States Patent [19]

[11] Patent Number: Des. 414,981

Roskind et al.

[45] Date of Patent: ** Oct. 12, 1999

[54] FRY PAN WITH SLANTED COOKING SURFACE

[76] Inventors: **Robert A. Roskind; Harley J. Levitt**, both of 117 Creekview Cir., Carrboro, N.C. 27510

[**] Term: **14 Years**

[21] Appl. No.: **29/090,533**

[22] Filed: **Jul. 10, 1998**

[51] LOC (6) Cl. **07-02**

[52] U.S. Cl. **D7/359**

[58] Field of Search D7/323, 354-361; 220/573.1, 574, 912; 99/324, 339, 422, 445, 446, 448; 126/390

[56] References Cited

U.S. PATENT DOCUMENTS

D. 29,714	11/1898	Hall	D7/359
D. 297,604	9/1988	Hagberg et al.	D7/359
D. 373,285	9/1996	Coroama et al.	D7/359
D. 380,645	7/1997	Perlini	D7/359
676,479	6/1901	Wagner	99/445
1,707,532	4/1929	Moon	99/339
2,534,407	12/1950	Branberry	126/390
5,628,426	5/1997	Doyle et al.	220/608

Primary Examiner—Caron D. Veynar

Attorney, Agent, or Firm—Sand & Sebolt

[57] CLAIM

The ornamental design for a fry pan with slanted cooking surface, as shown and described.

DESCRIPTION

FIG. 1 is a top perspective view of the fry pan with slanted cooking surface showing our new design;
 FIG. 2 is a top plan view of the fry pan of FIG. 1;
 FIG. 3 is a bottom plan view of the fry pan of FIG. 1;
 FIG. 4 is a front elevational view of the fry pan of FIG. 2;
 FIG. 5 is a rear elevational view of the fry pan of FIG. 2;
 FIG. 6 is a left side elevational view of the fry pan of FIG. 2;
 FIG. 7 is a right side elevational view of the fry pan of FIG. 2;
 FIG. 8 is a top perspective view of an alternative embodiment of the fry pan;
 FIG. 9 is a top plan view of the fry pan of FIG. 8;
 FIG. 10 is a bottom plan view of the fry pan of FIG. 8;
 FIG. 11 is a front elevational view of the fry pan of FIG. 9;
 FIG. 12 is a rear elevational view of the fry pan of FIG. 9;
 FIG. 13 is a left side elevational view of the fry pan of FIG. 9; and,
 FIG. 14 is a right side elevational view of the fry pan of FIG. 9.

1 Claim, 10 Drawing Sheets

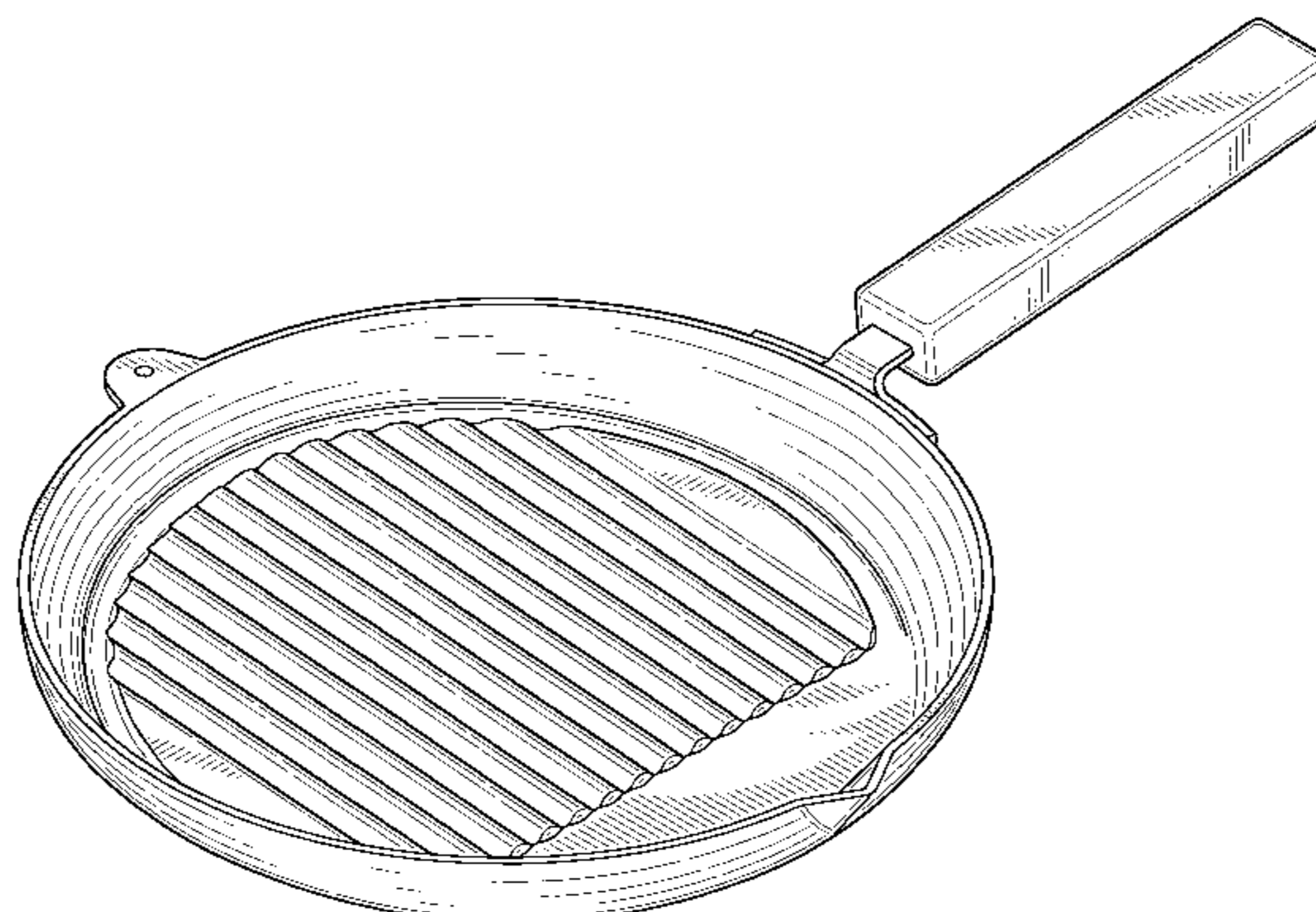
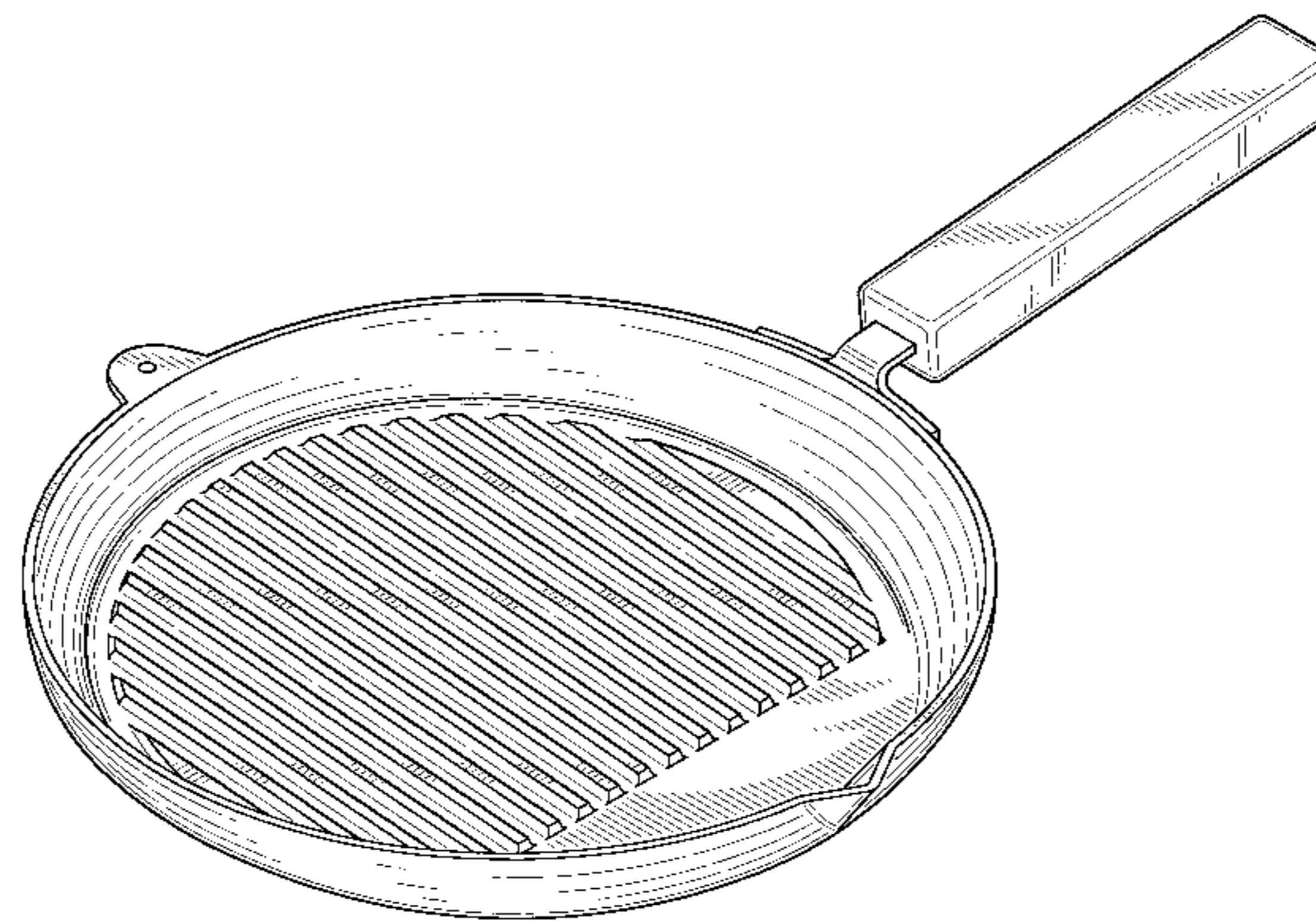

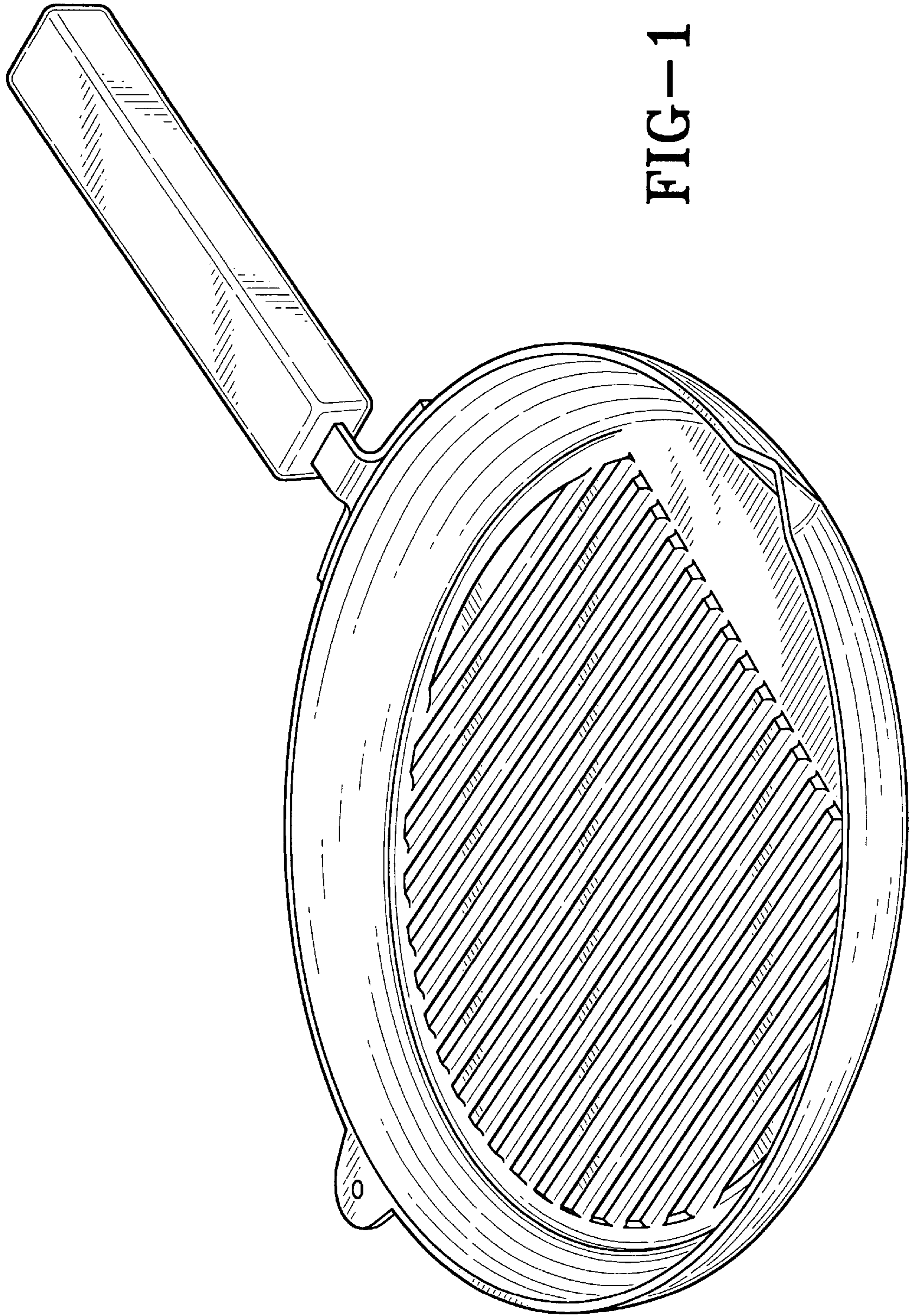

FIG-1

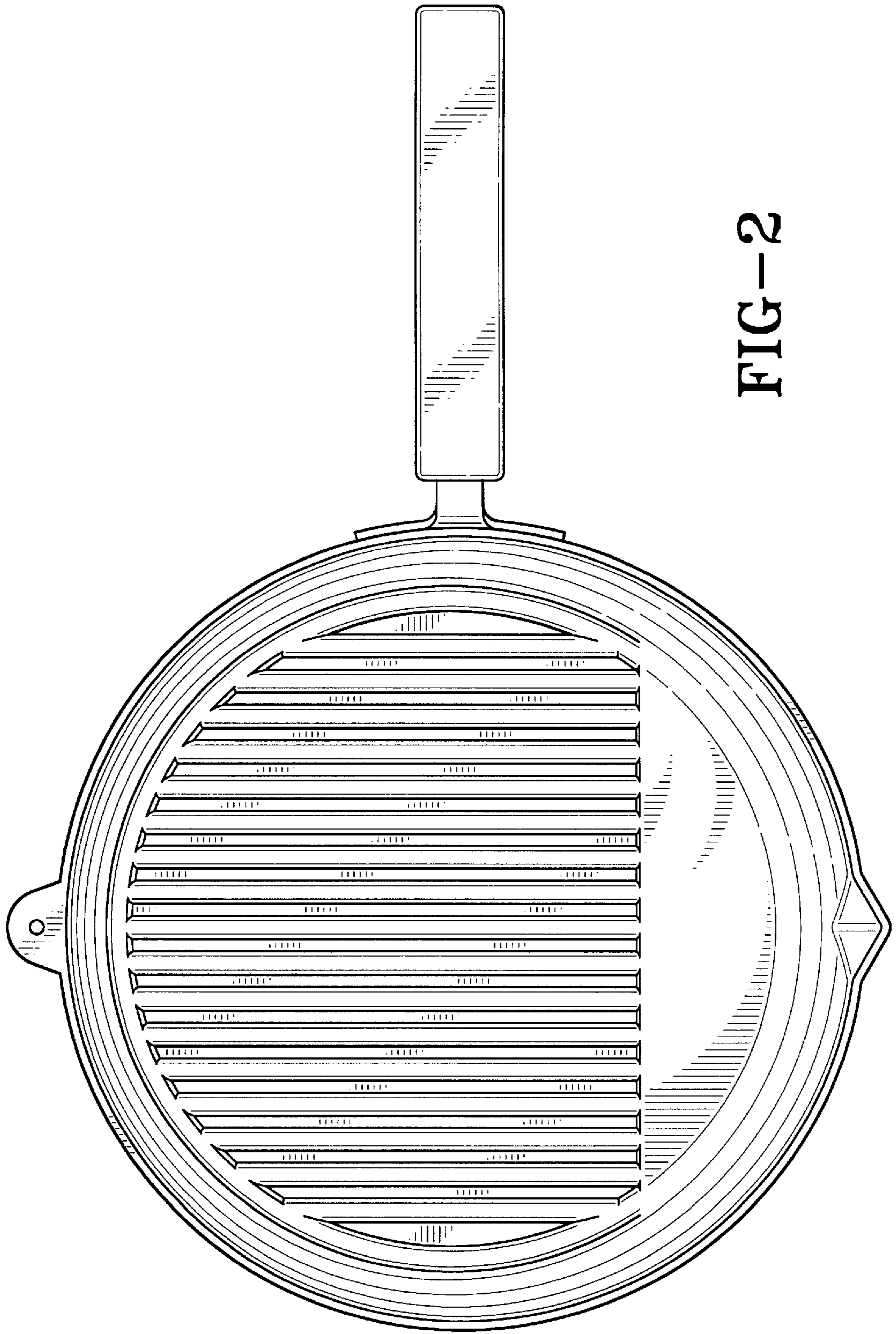

FIG-2

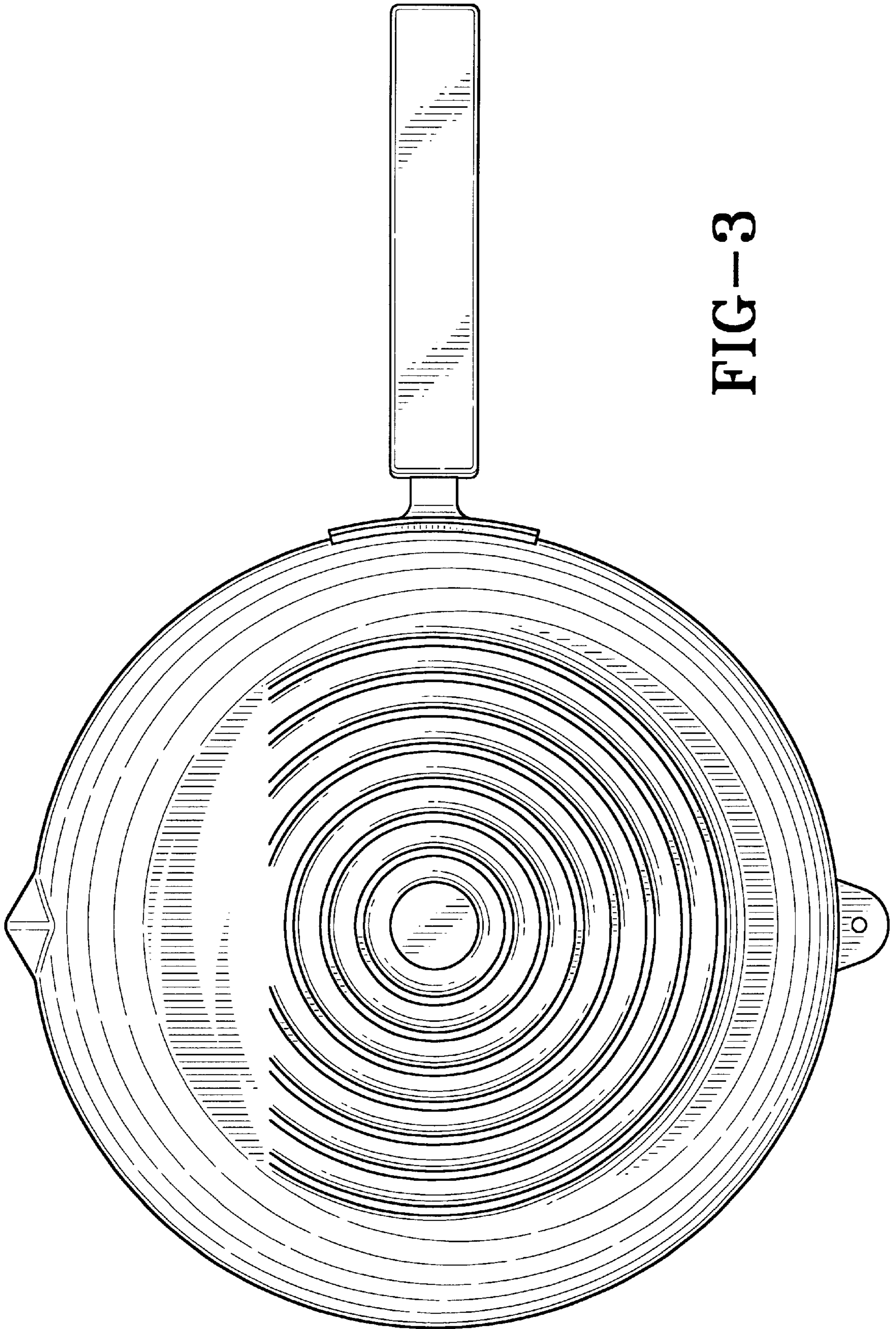

FIG-3

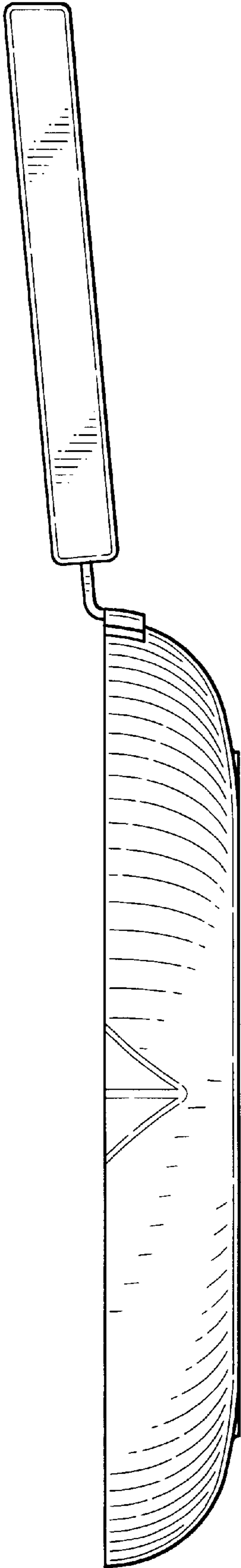

FIG-4

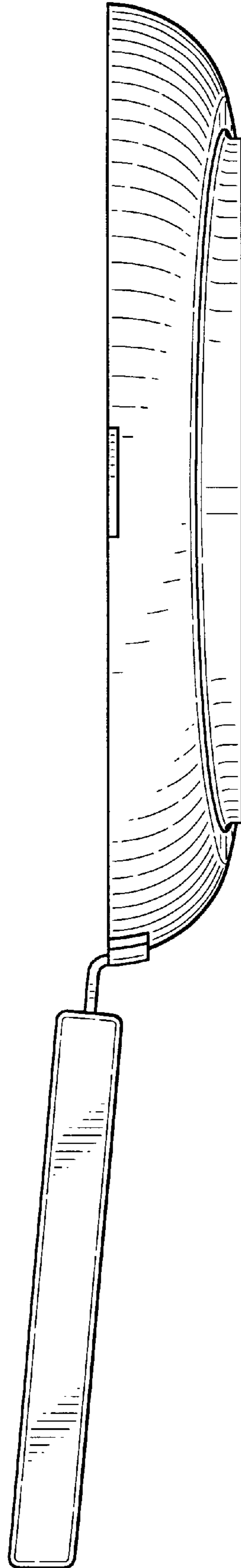

FIG-5

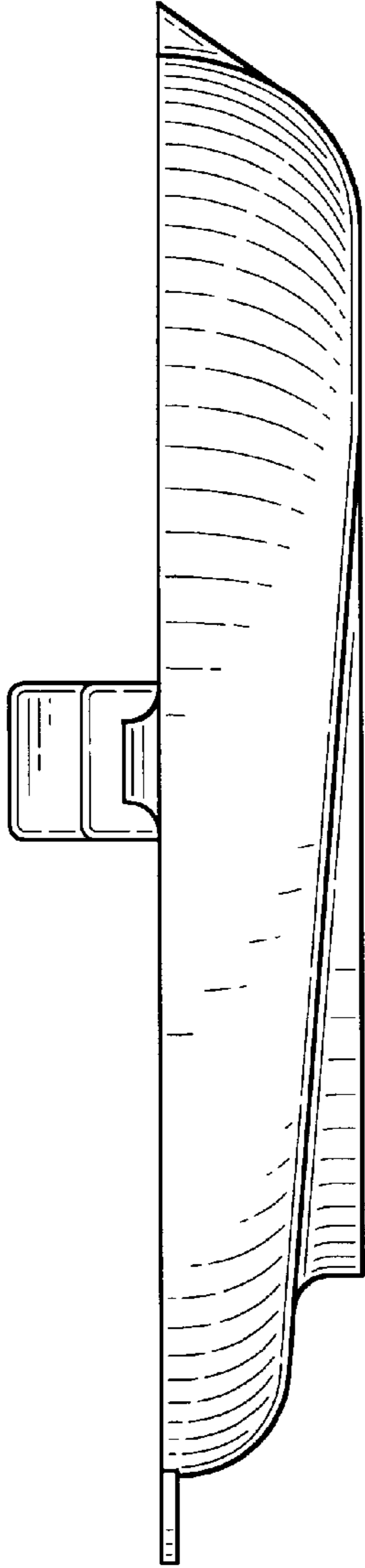

FIG-6

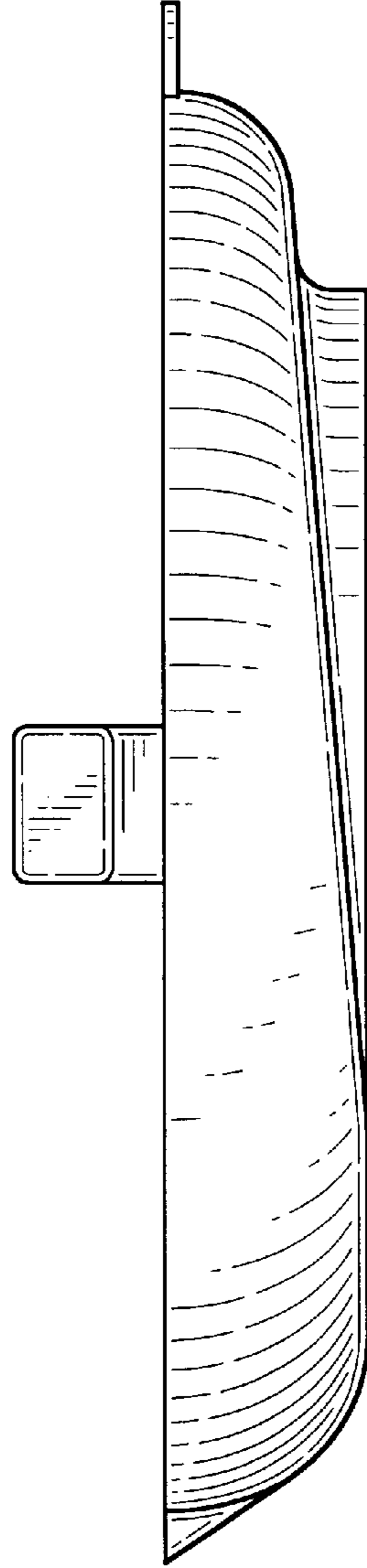

FIG-7

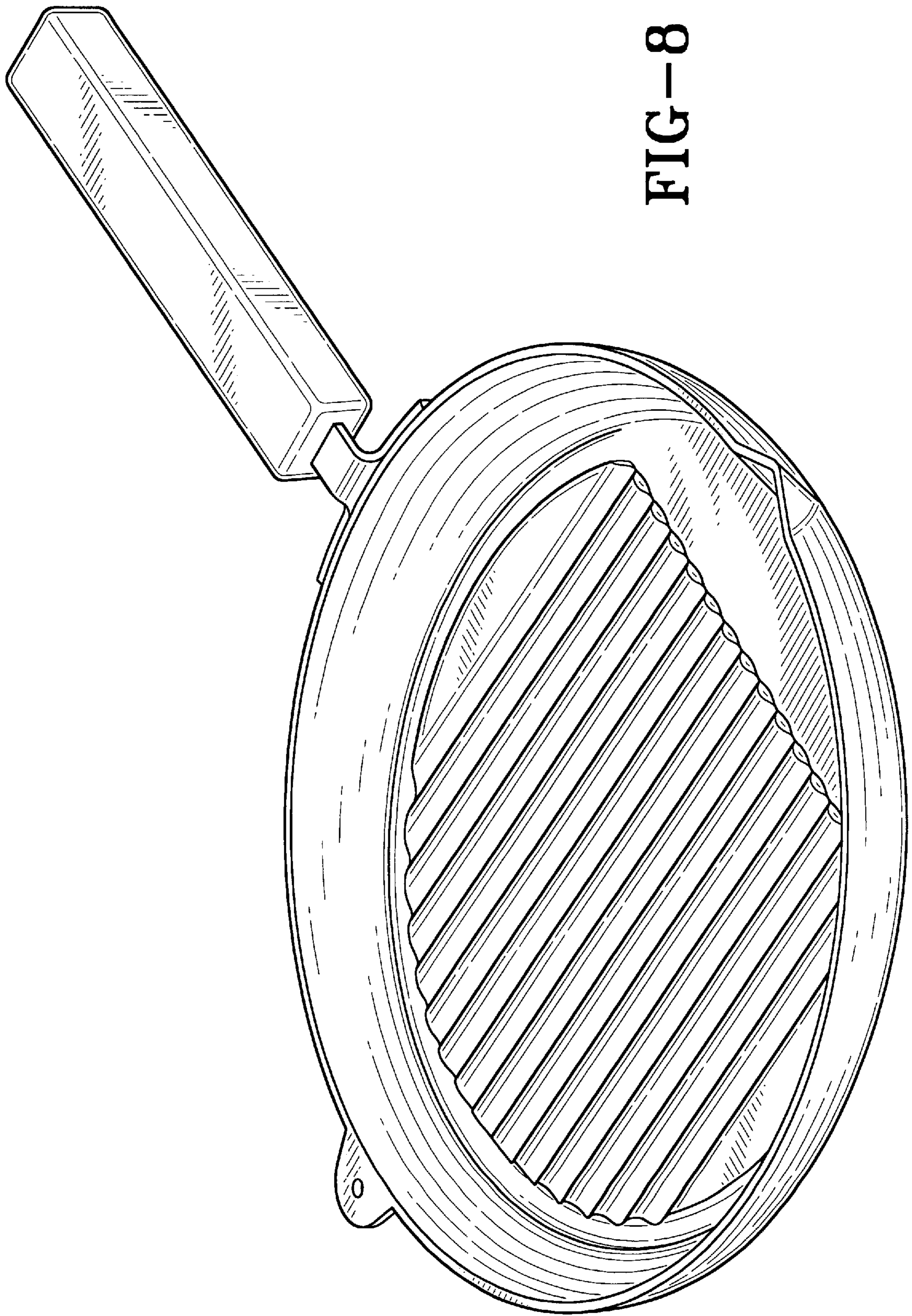

FIG-8

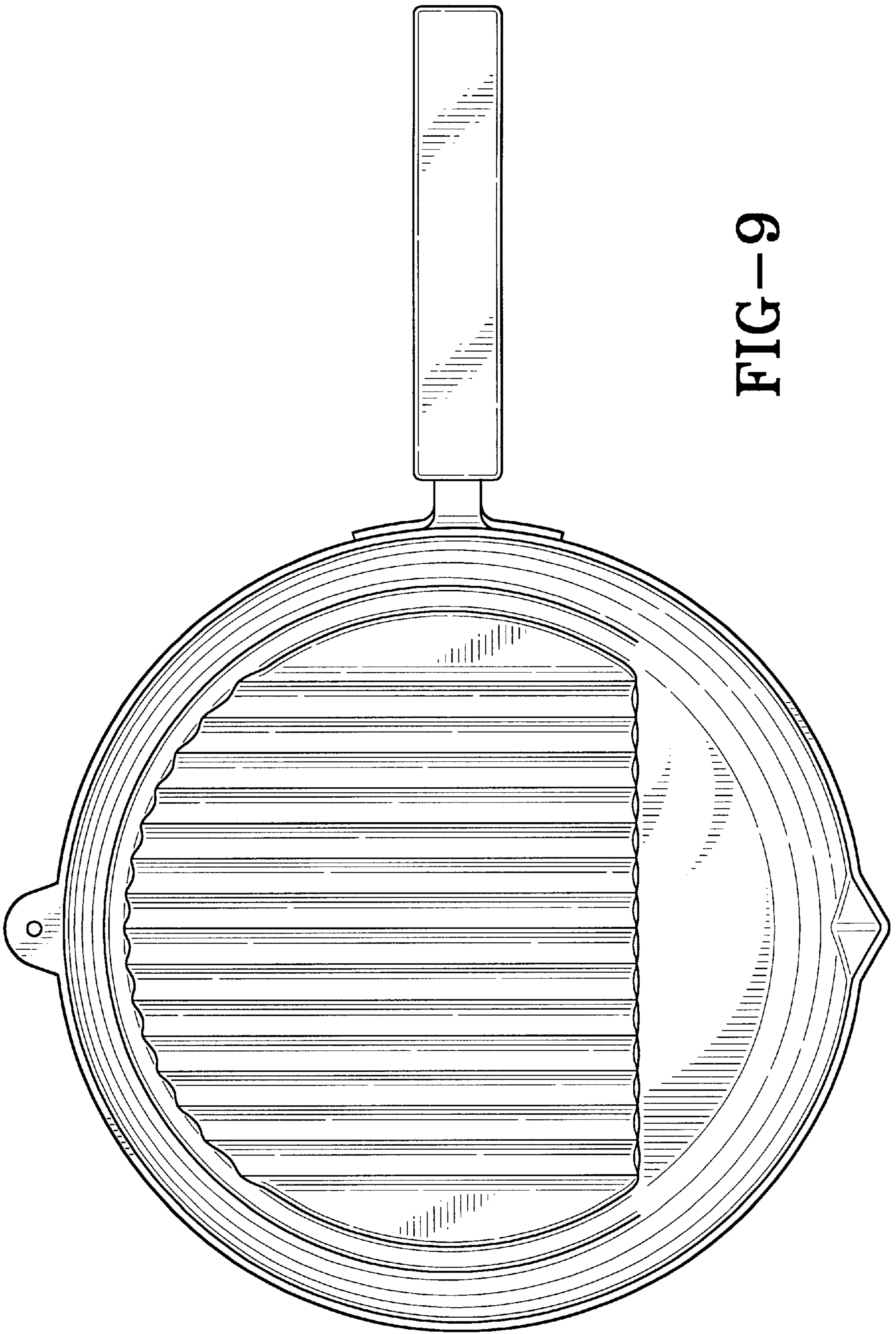

FIG-9

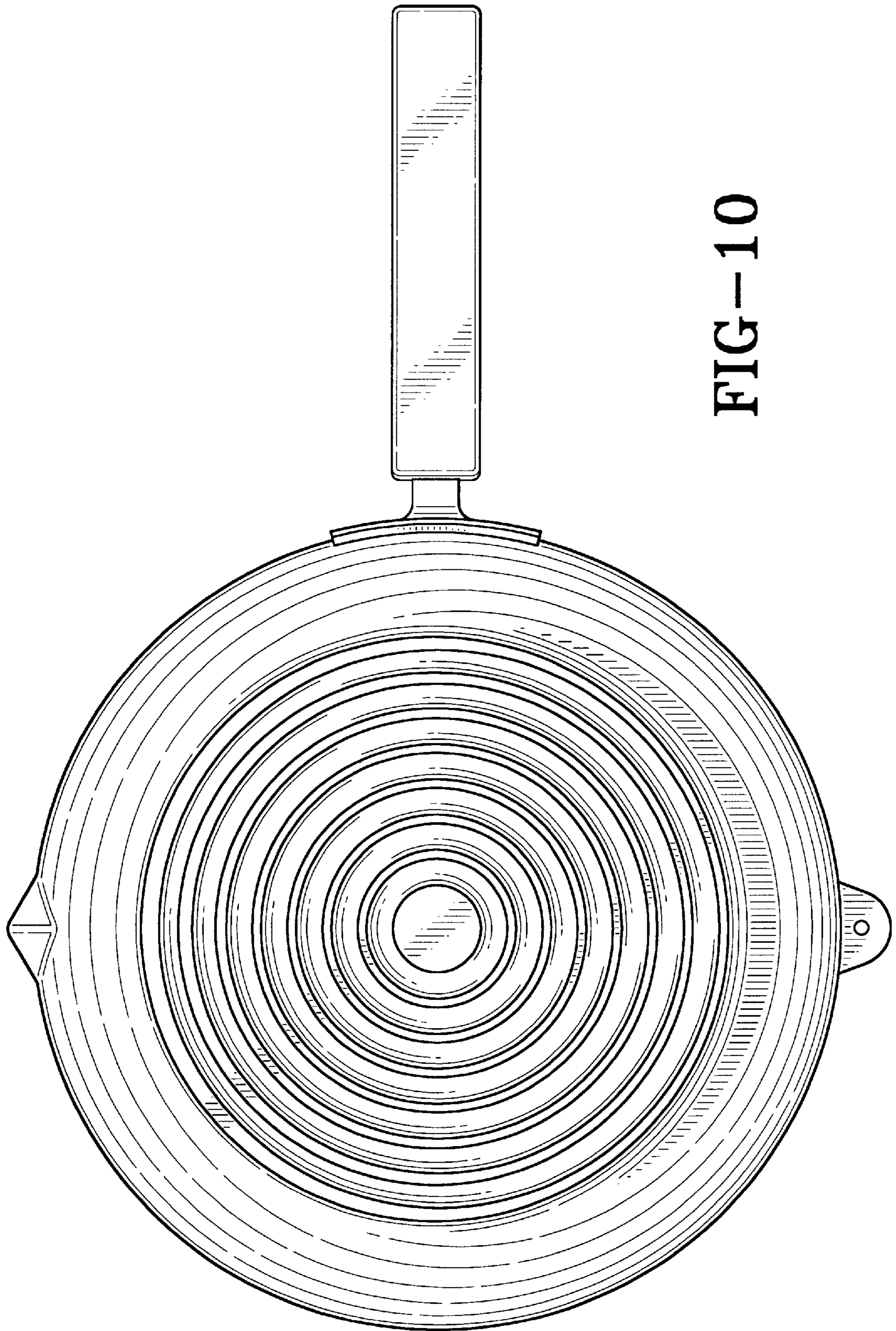

FIG-10

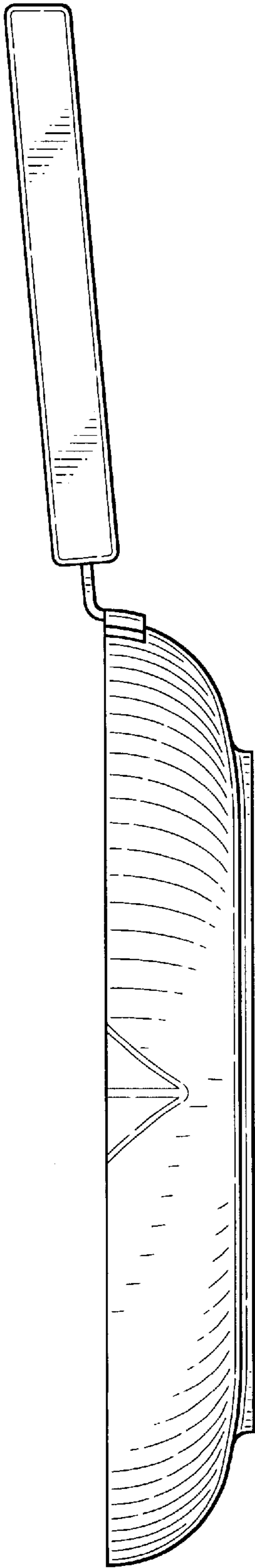

FIG-11

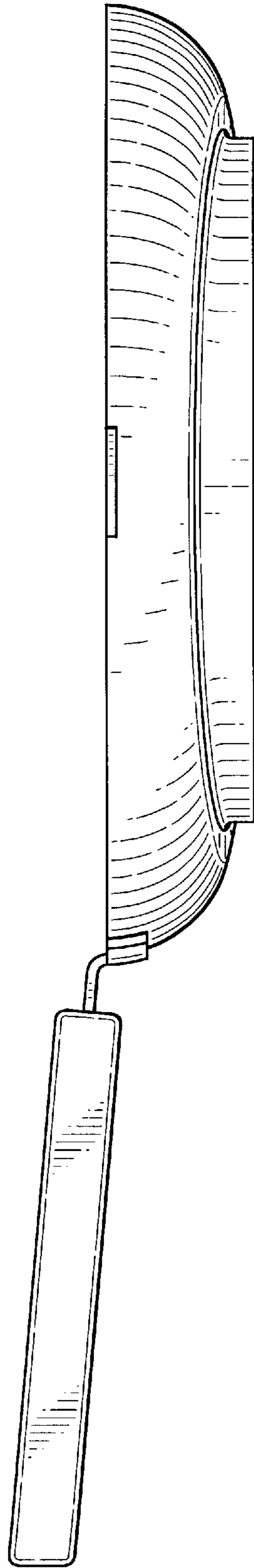

FIG-12

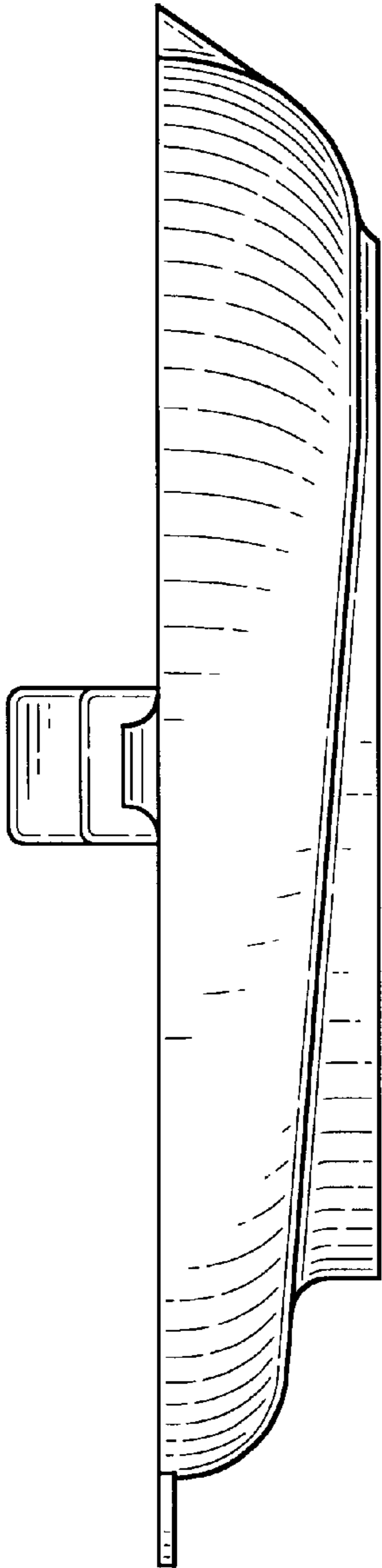

FIG-13

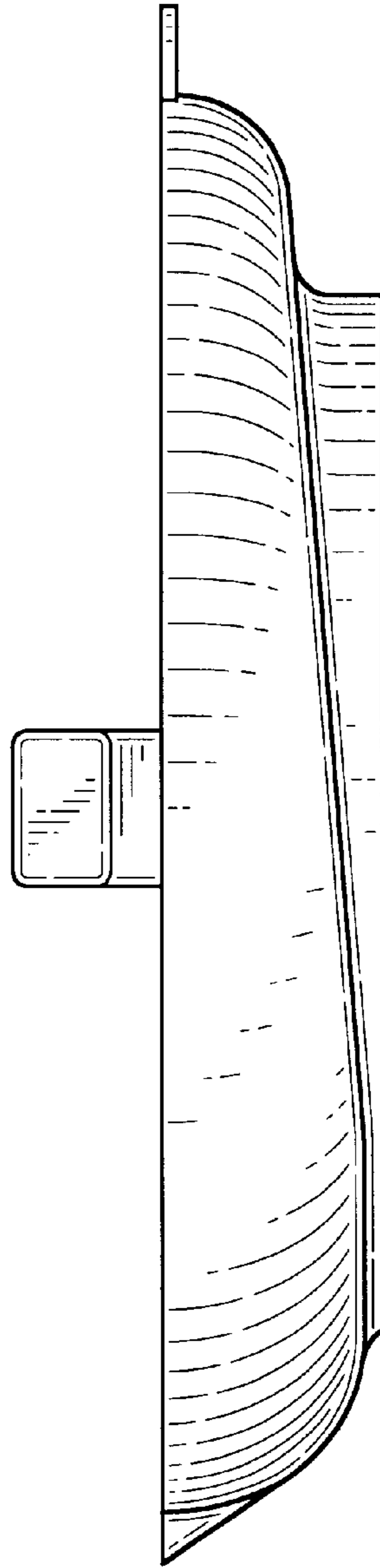

FIG-14