



US00D414978S

United States Patent [19] Brückner

[11] Patent Number: **Des. 414,978**

[45] Date of Patent: **** Oct. 12, 1999**

[54] **FLASK WITH HANDLE**

[75] Inventor: **Andreas Brückner**, Stuttgart, Germany

[73] Assignee: **Dart Industries Inc.**, Orlando, Fla.

[**] Term: **14 Years**

[21] Appl. No.: **29/053,935**

[22] Filed: **Jun. 7, 1996**

[51] **LOC (6) Cl.** **07-01**

[52] **U.S. Cl.** **D7/318; D7/317; D7/316**

[58] **Field of Search** D7/316, 317, 318,
D7/319, 622, 300.1, 608, 600, 321, 598;
722/465.1

[56] **References Cited**

U.S. PATENT DOCUMENTS

- D. 48,354 12/1915 Mischler D7/300.1 X
- D. 87,014 5/1932 McDonald D7/598
- D. 220,773 5/1971 Dilyard D7/317
- D. 244,339 5/1977 Wendt D7/317
- D. 302,370 7/1989 Gibert D7/317
- D. 308,926 7/1990 Zivin D7/319
- D. 311,475 10/1990 Durand D7/317
- D. 323,951 2/1992 Inoue D7/317
- D. 325,687 4/1992 Embree .
- D. 326,978 6/1992 Zimmermann D7/318 X
- D. 331,862 12/1992 Minuti D7/598
- D. 338,367 8/1993 Fonville D7/316 X

- D. 338,591 8/1993 Wyatt et al. D7/316 X
- D. 356,004 3/1995 Van Valkenburg et al. D7/316 X
- D. 370,150 5/1996 Huang D7/318 X
- D. 370,384 6/1996 Shamis D7/622 X
- 1,568,691 1/1926 Pierson D7/300.1
- 2,598,747 6/1952 Alex .
- 2,805,561 9/1957 Emmert et al. .
- 2,981,562 4/1961 Long .
- 3,371,807 3/1968 Clouser et al. .
- 5,224,634 7/1993 Graham .

FOREIGN PATENT DOCUMENTS

2039214 8/1989 United Kingdom .

Primary Examiner—M. N. Pandozzi
Attorney, Agent, or Firm—John A. Doninger

[57] **CLAIM**

The ornamental design for a flask with handle, as shown.

DESCRIPTION

FIG. 1 is a top, side and rear perspective view of a flask with handle showing my new design;
FIG. 2 is an exploded perspective view thereof;
FIG. 3 is a left side view thereof;
FIG. 4 is a top plan view thereof;
FIG. 5 is a right side view thereof;
FIG. 6 is a bottom plan view thereof;
FIG. 7 is a rear view thereof; and,
FIG. 8 is a front view thereof.

1 Claim, 4 Drawing Sheets

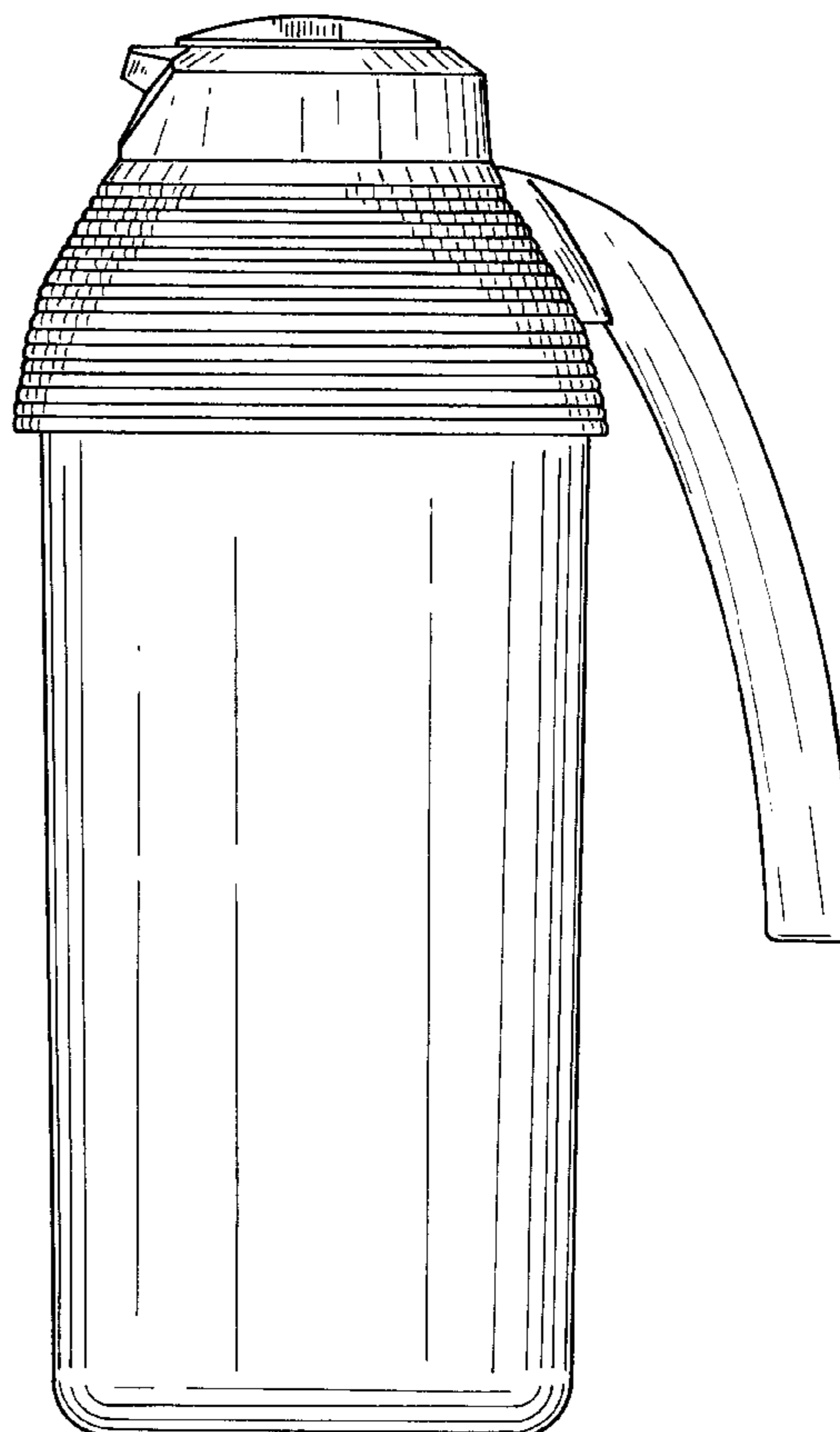
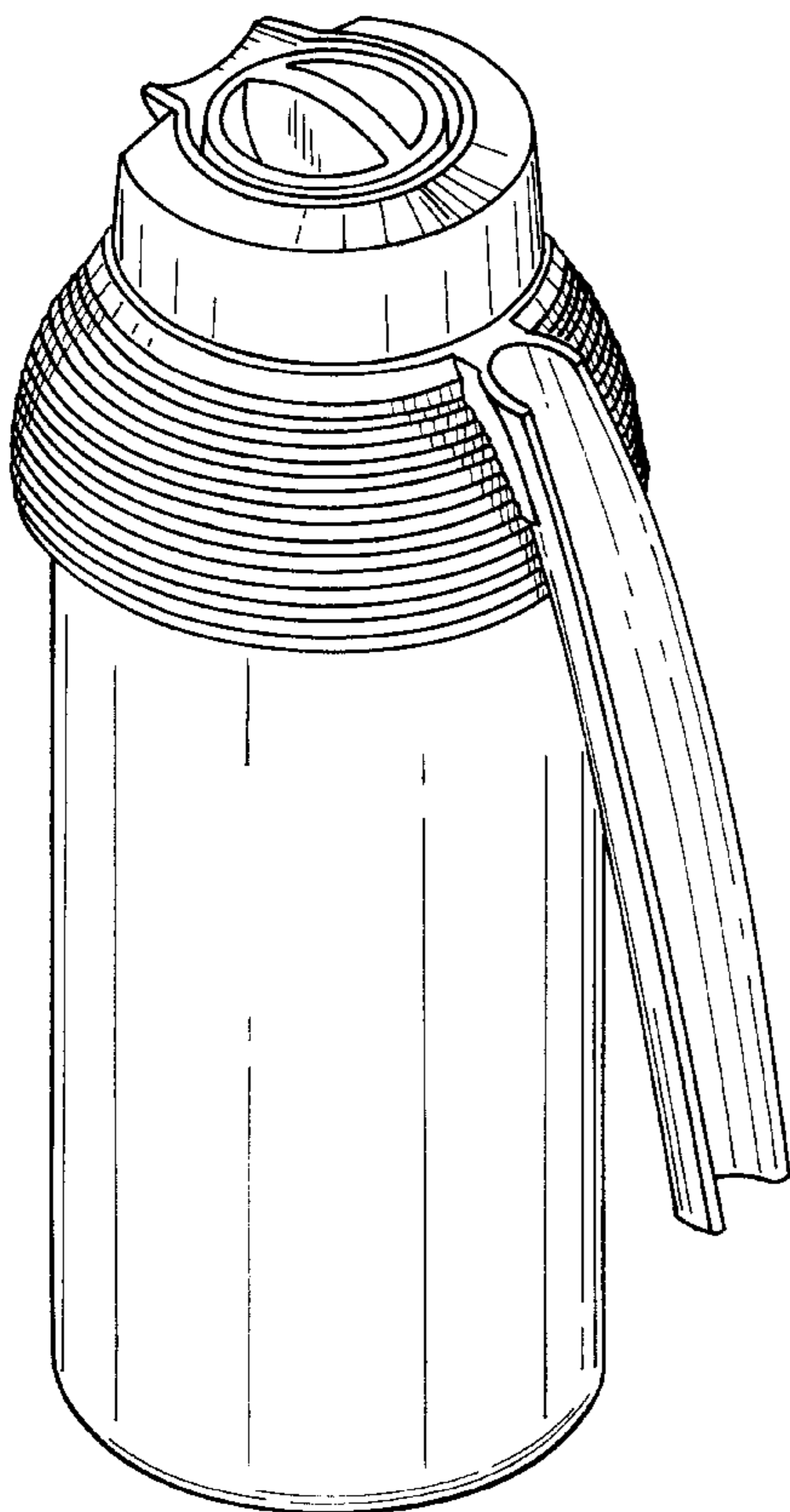

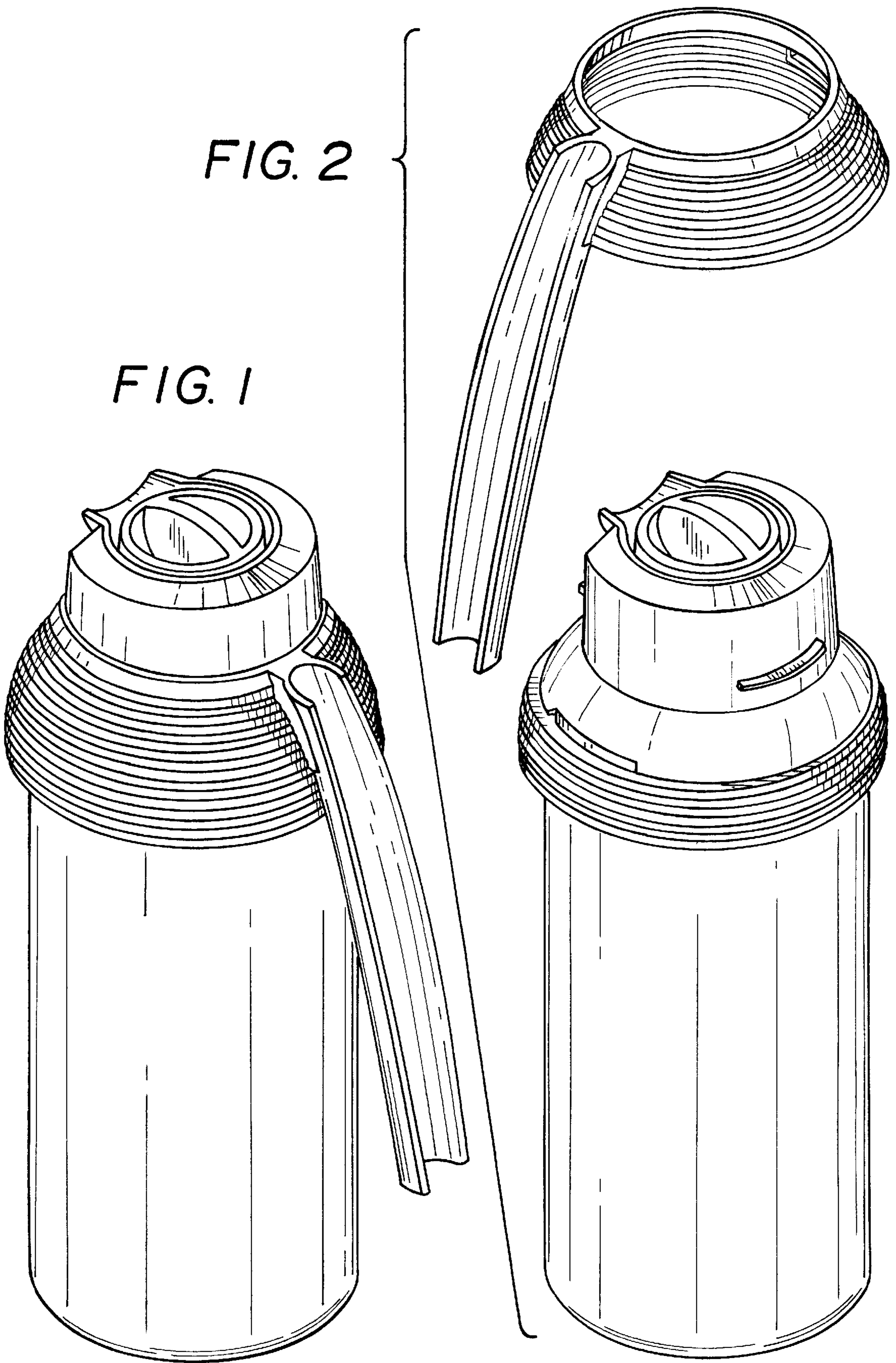

FIG. 2

FIG. 1

FIG. 3

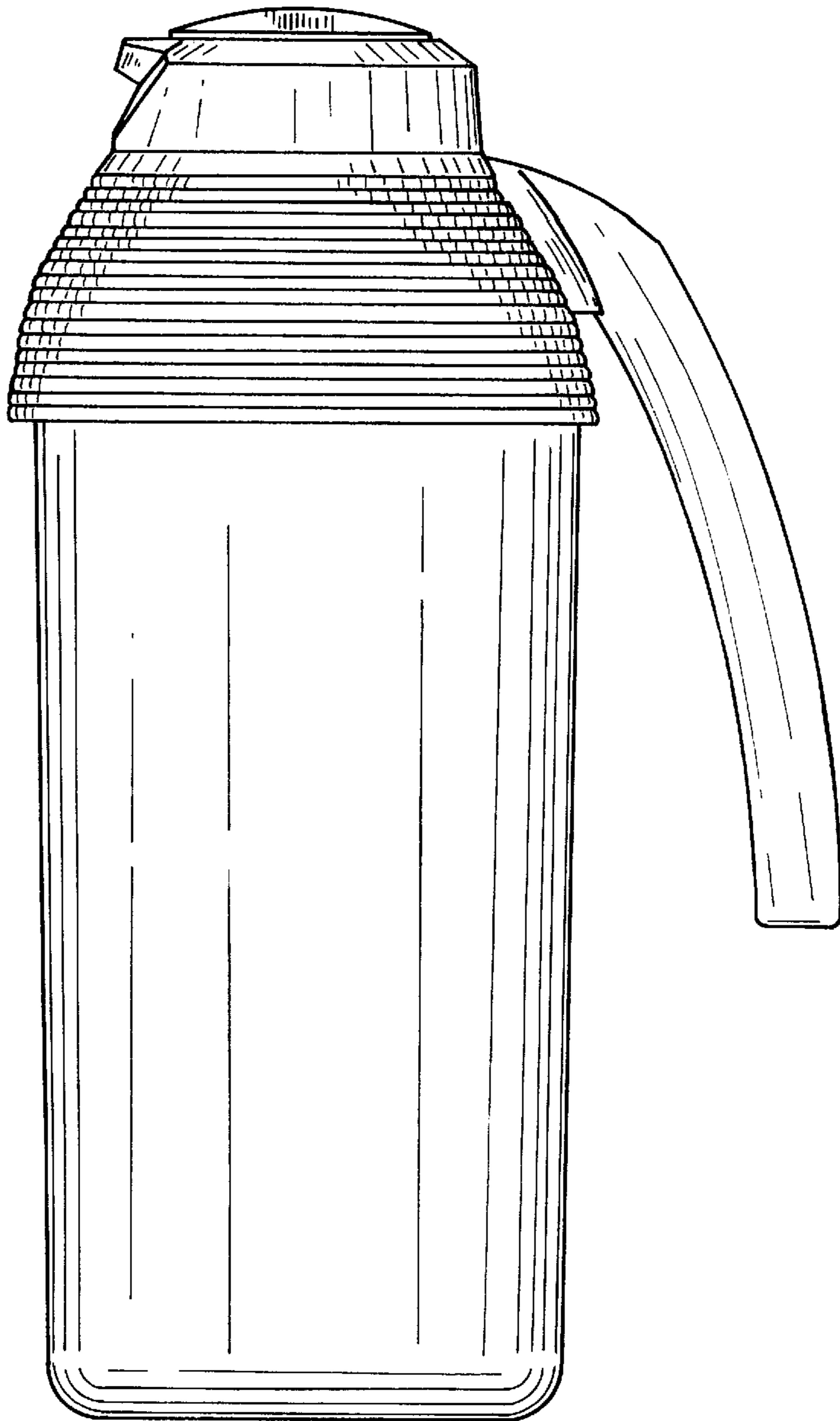
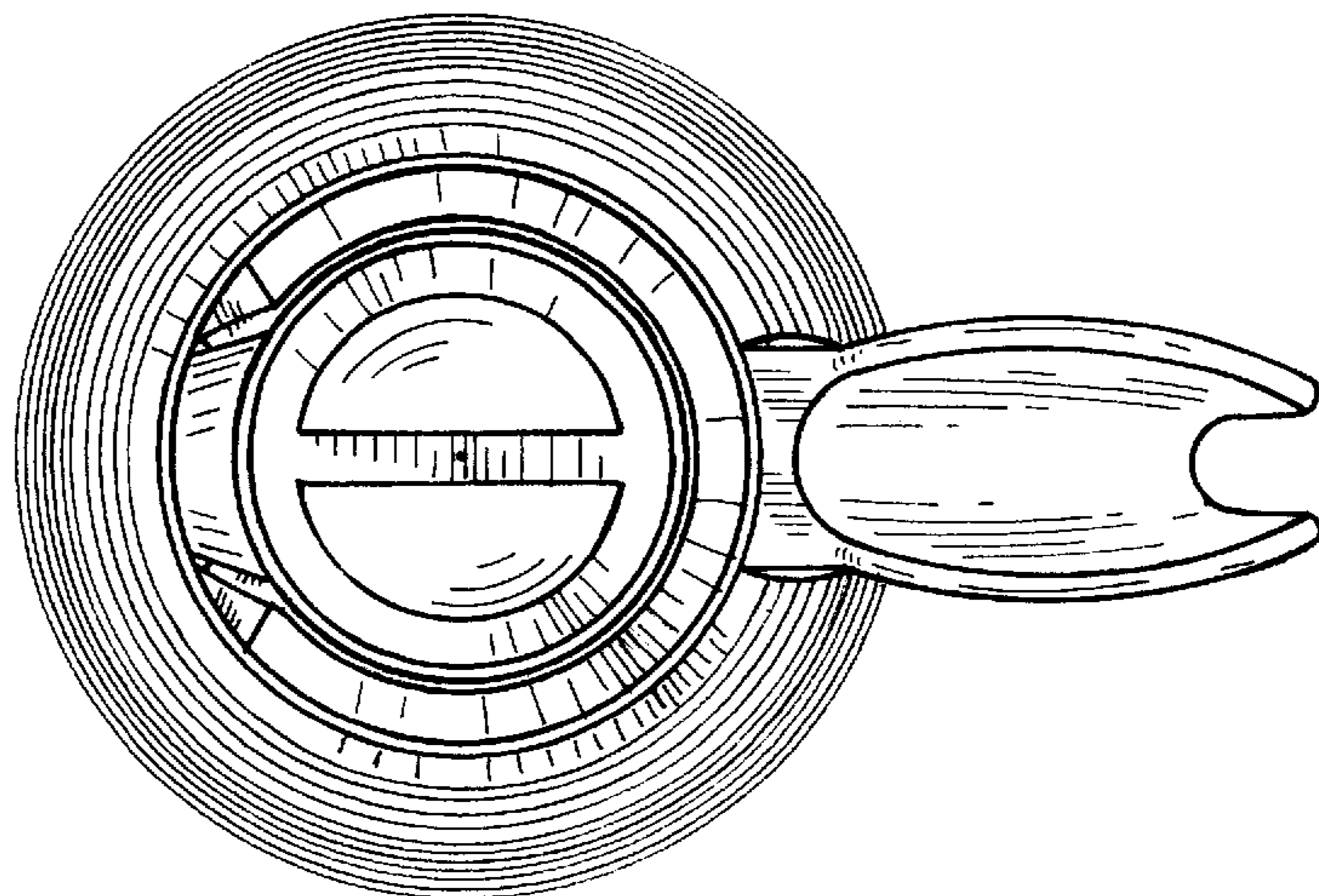

FIG. 4



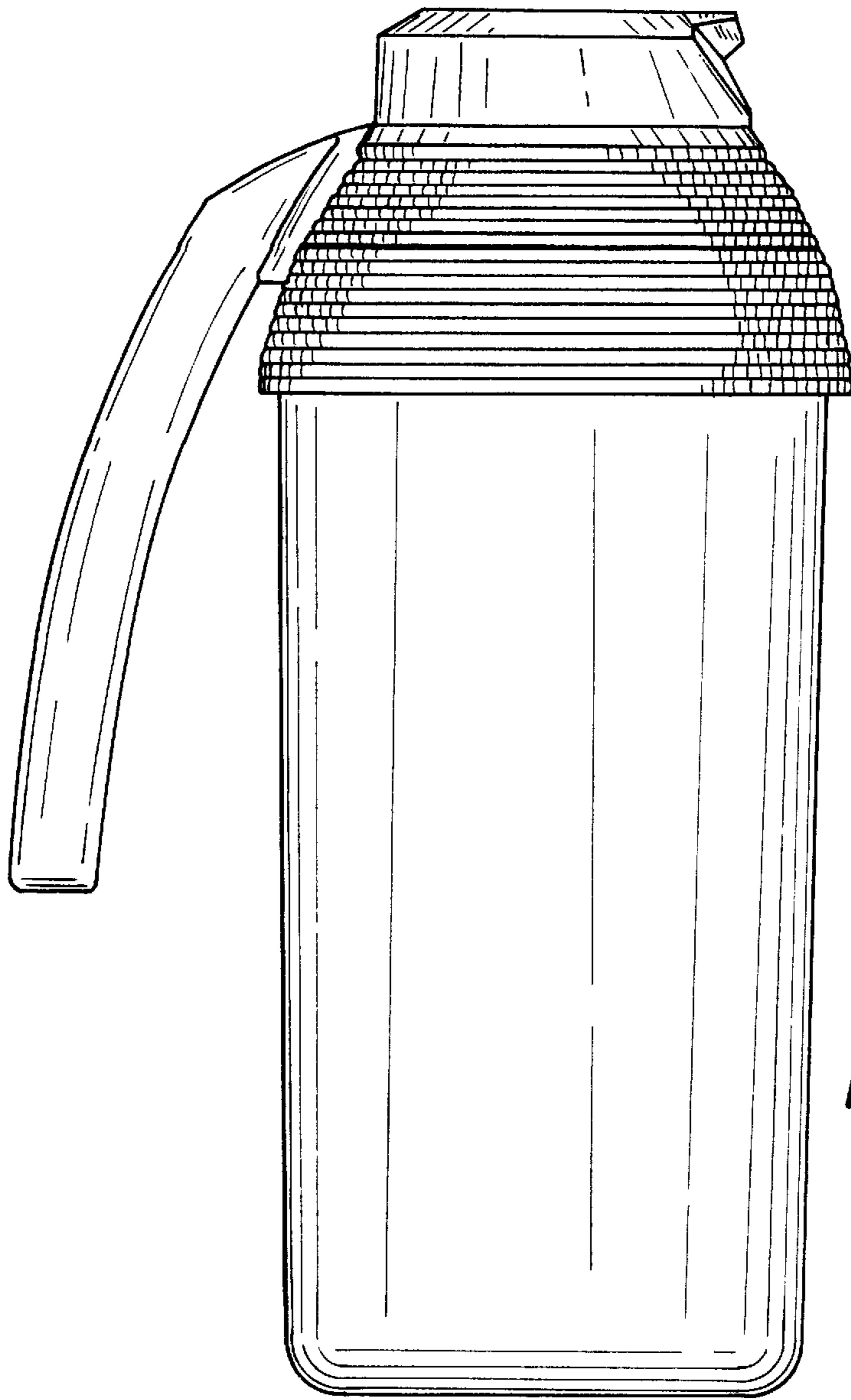
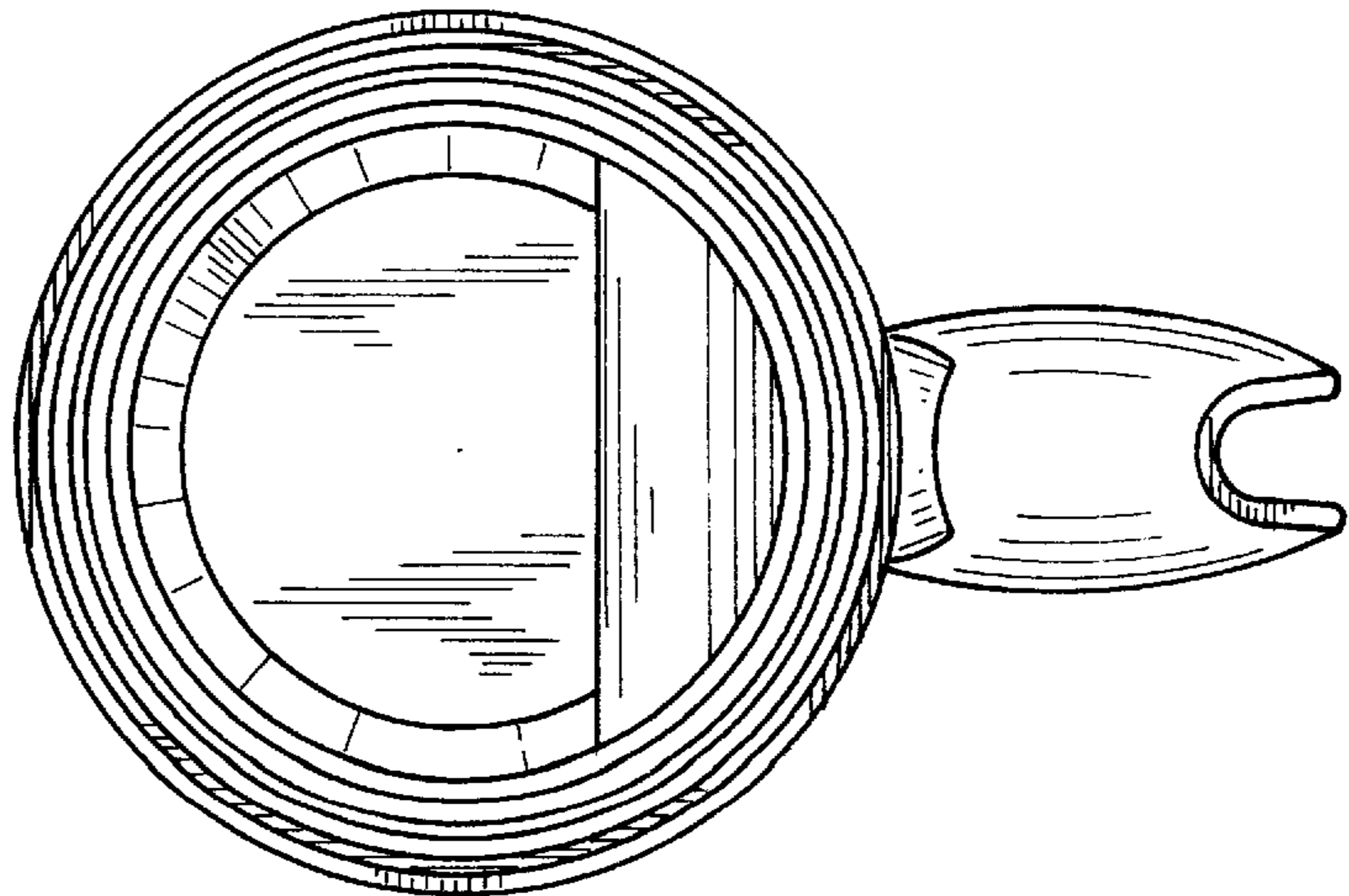

FIG. 5

FIG. 6



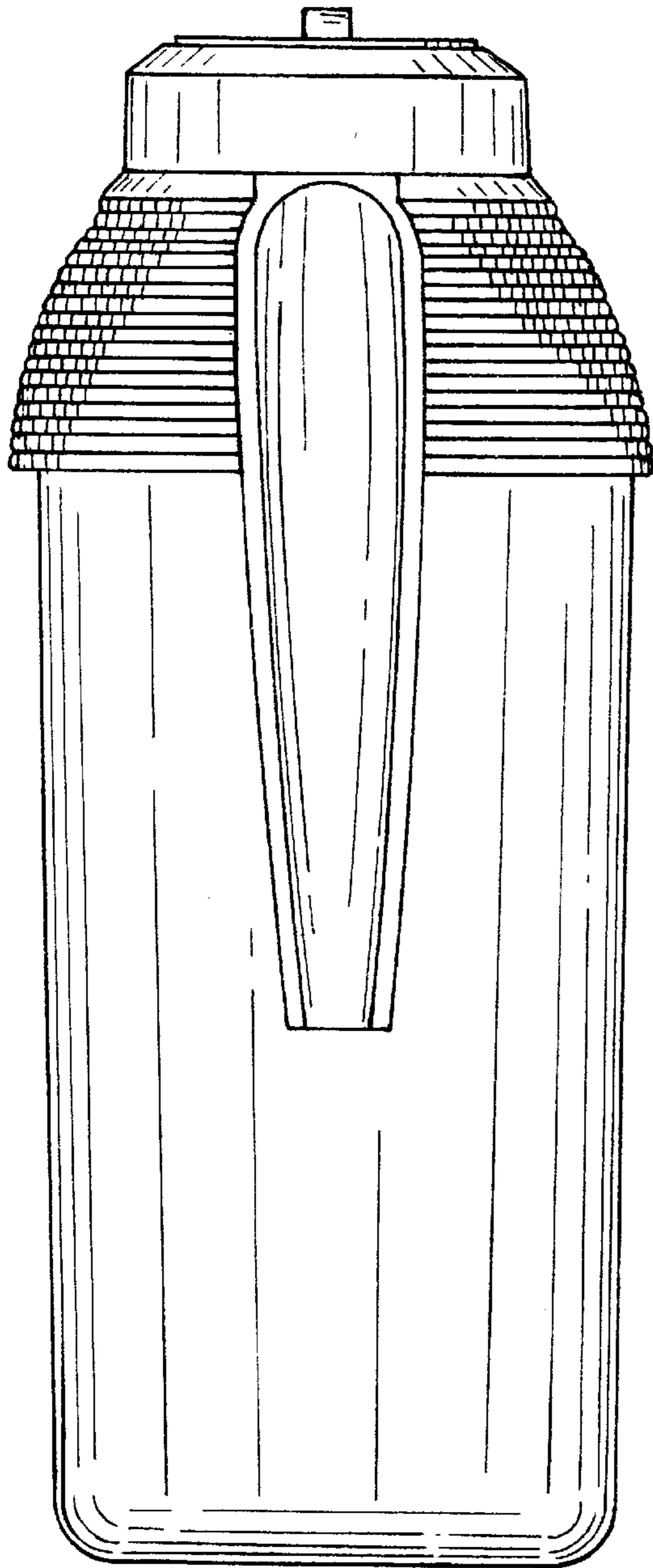

FIG. 7

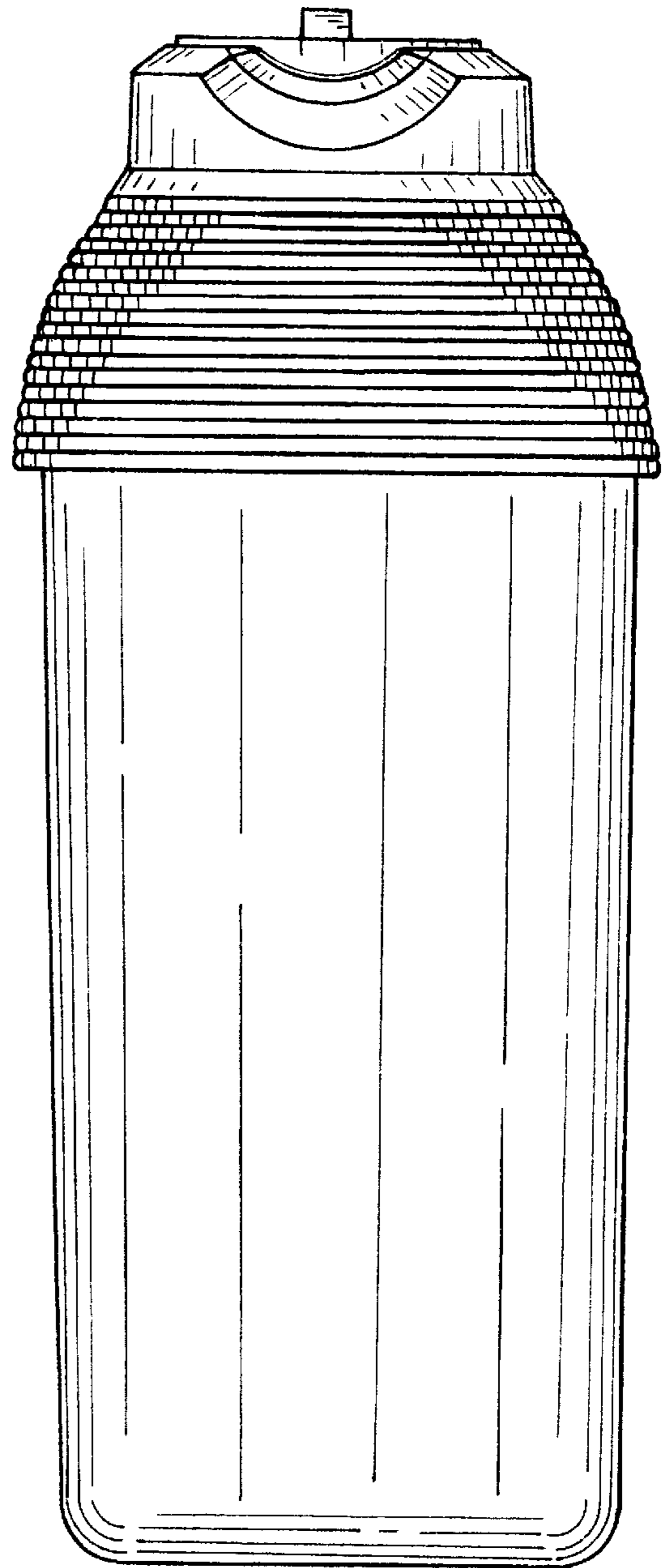

FIG. 8