



US00D414959S

United States Patent [19]

Emerson

[11] **Patent Number: Des. 414,959**

[45] **Date of Patent: ** Oct. 12, 1999**

[54] **TRAY**

[75] Inventor: **Marcia Kim Emerson**, Windsor, Colo.

[73] Assignee: **Journey, Inc.**, Windsor, Colo.

[**] Term: **14 Years**

[21] Appl. No.: **29/103,106**

[22] Filed: **Apr. 8, 1999**

[51] **LOC (6) Cl. 06-04**

[52] **U.S. Cl. D6/418**

[58] **Field of Search** D6/509-511, 336;
D7/552.1; D19/86, 92; 297/135, 160, 161;
211/88.01, 90.01, 133.6, 126.1, 186; 108/42,
152, 157, 13, 157.11; 248/239, 245, 235,
250

[56] **References Cited**

U.S. PATENT DOCUMENTS

D. 186,181 9/1959 Silkenat D7/552.1

D. 292,352 10/1987 Hampshire D6/418
D. 293,404 12/1987 Murphy D6/418 X
D. 366,170 1/1996 Temple D6/511

Primary Examiner—Doris V. Coles
Assistant Examiner—Linda Brooks
Attorney, Agent, or Firm—Dean P. Edmundson

[57] **CLAIM**

The ornamental design for a tray, as shown and described.

DESCRIPTION

FIG. 1 is a front perspective view of a tray of my design;
FIG. 2 is a front elevational view thereof;
FIG. 3 is a left side elevational view thereof, the right side
elevational view being a mirror image thereof;
FIG. 4 is a rear elevational view thereof;
FIG. 5 is a top plan view thereof; and,
FIG. 6 is a bottom plan view thereof.

1 Claim, 6 Drawing Sheets

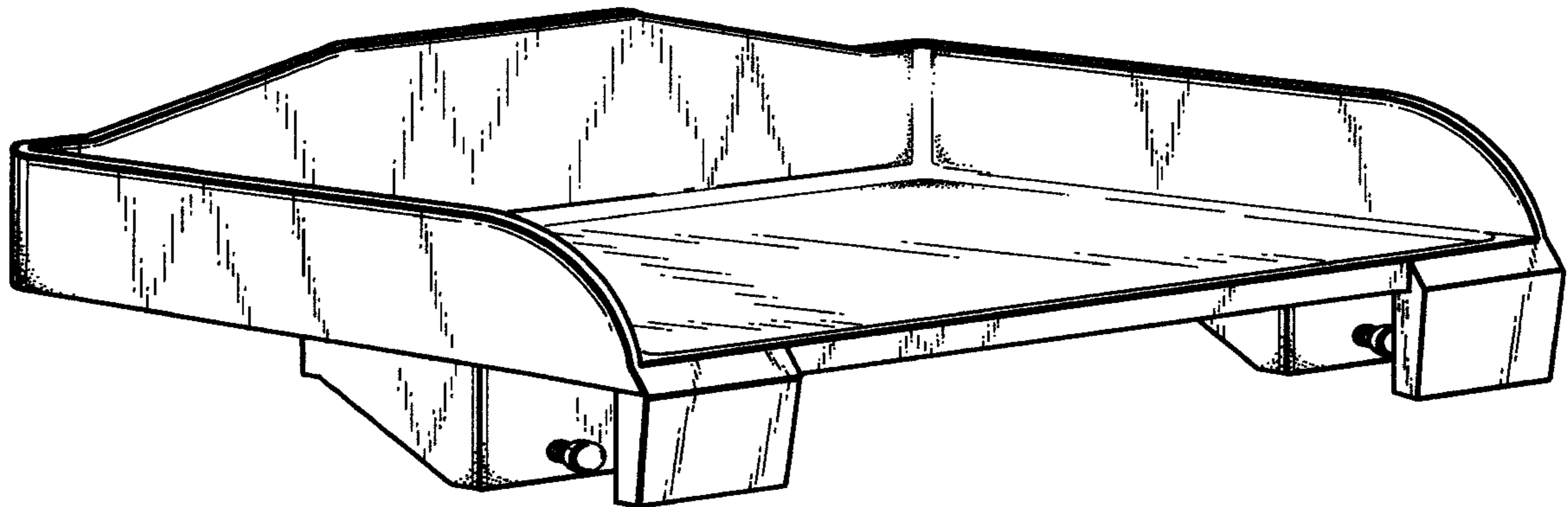

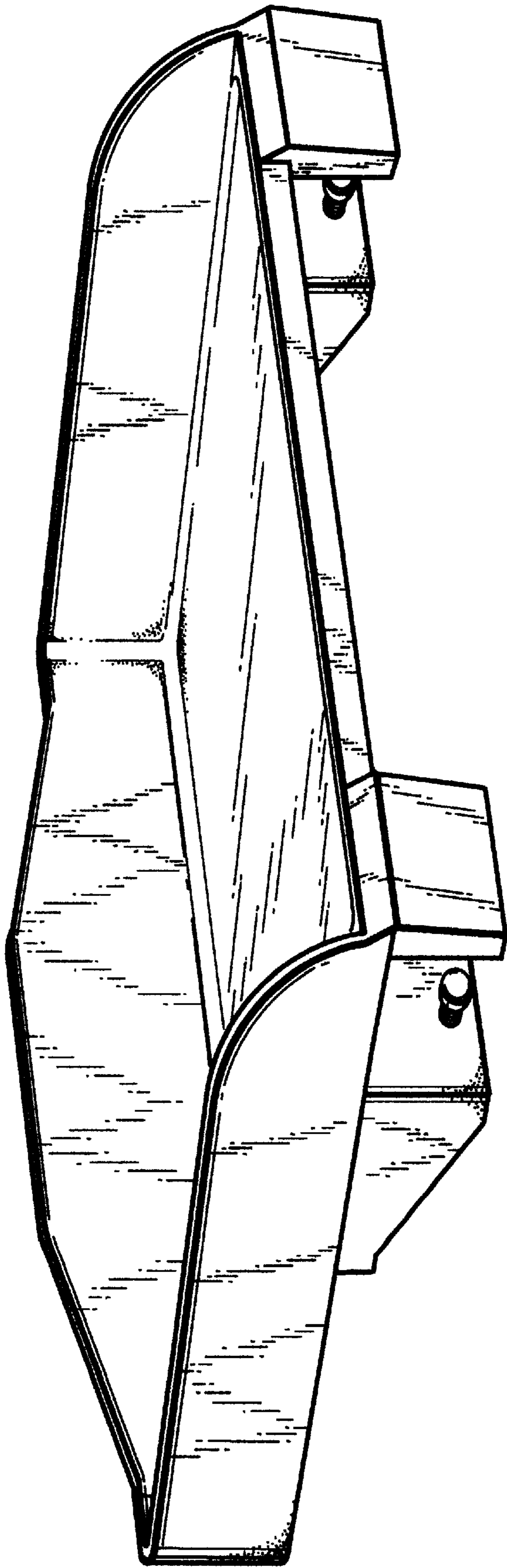

FIGURE 1

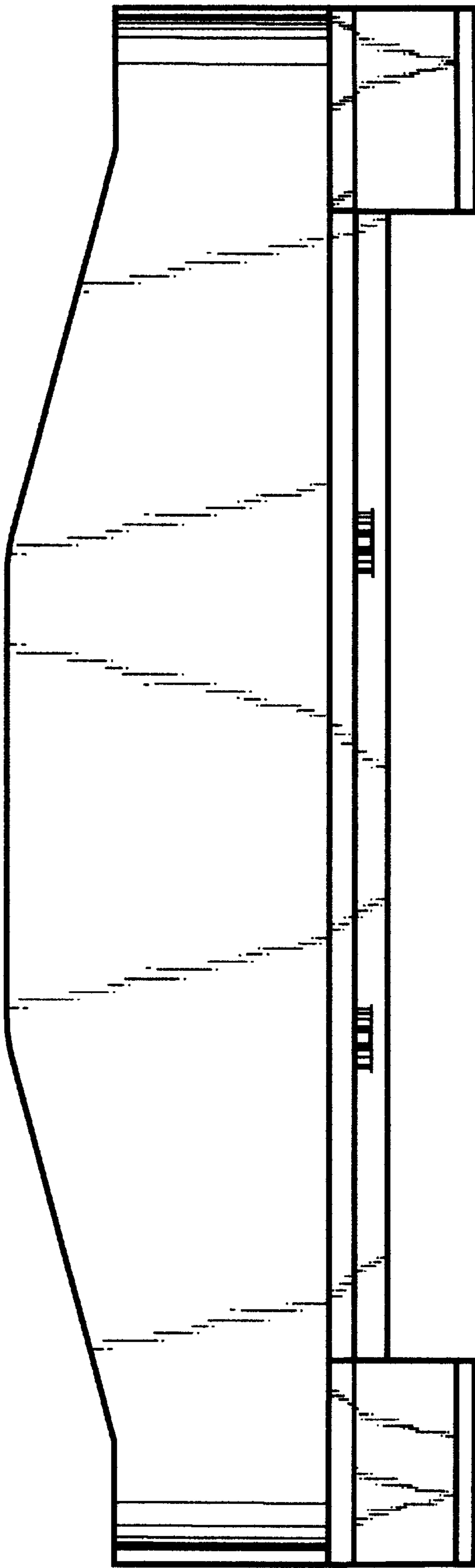

FIGURE 2

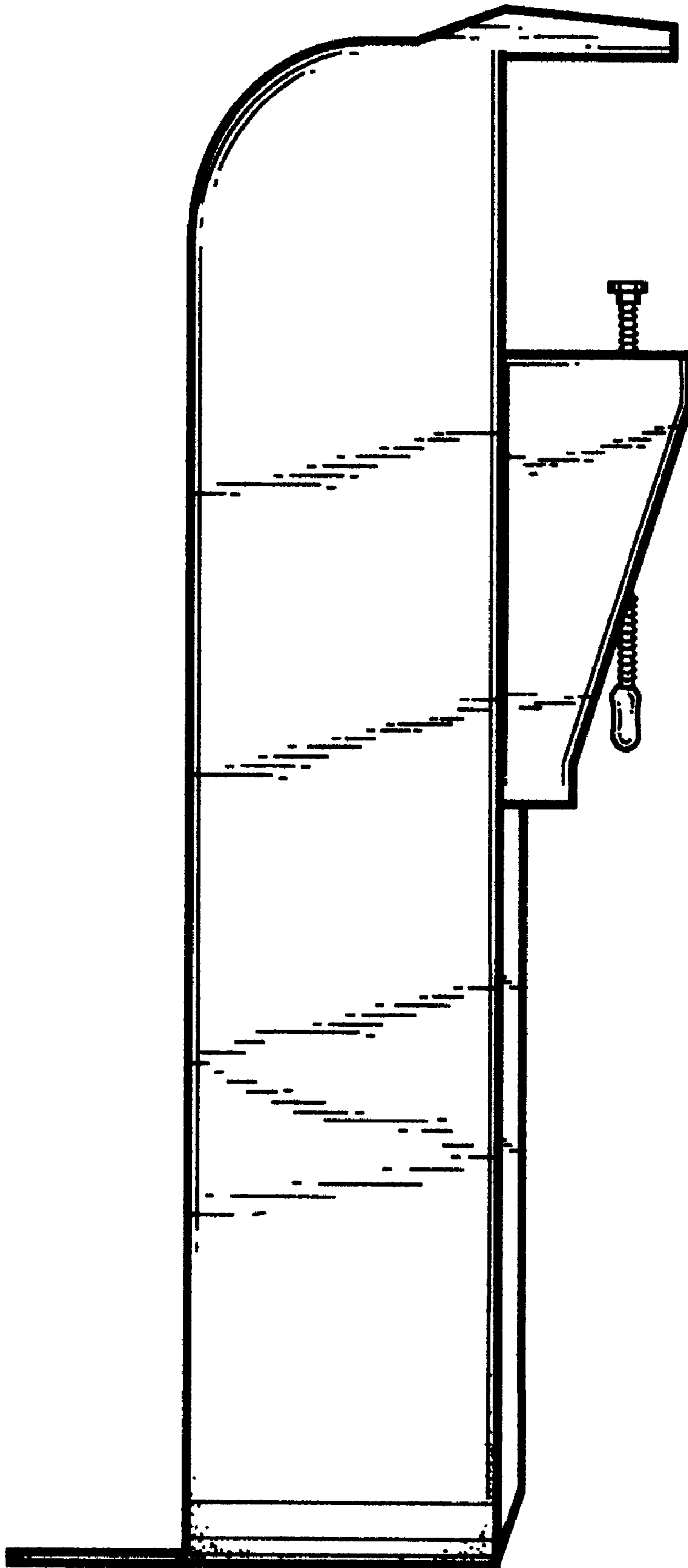

FIGURE 3

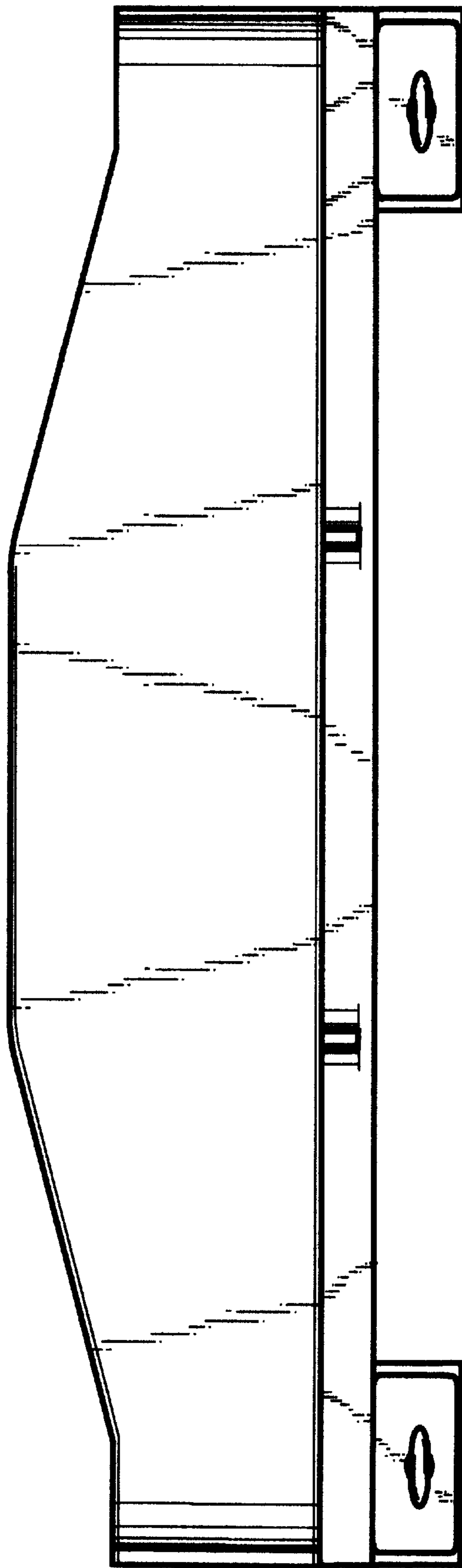

FIGURE 4

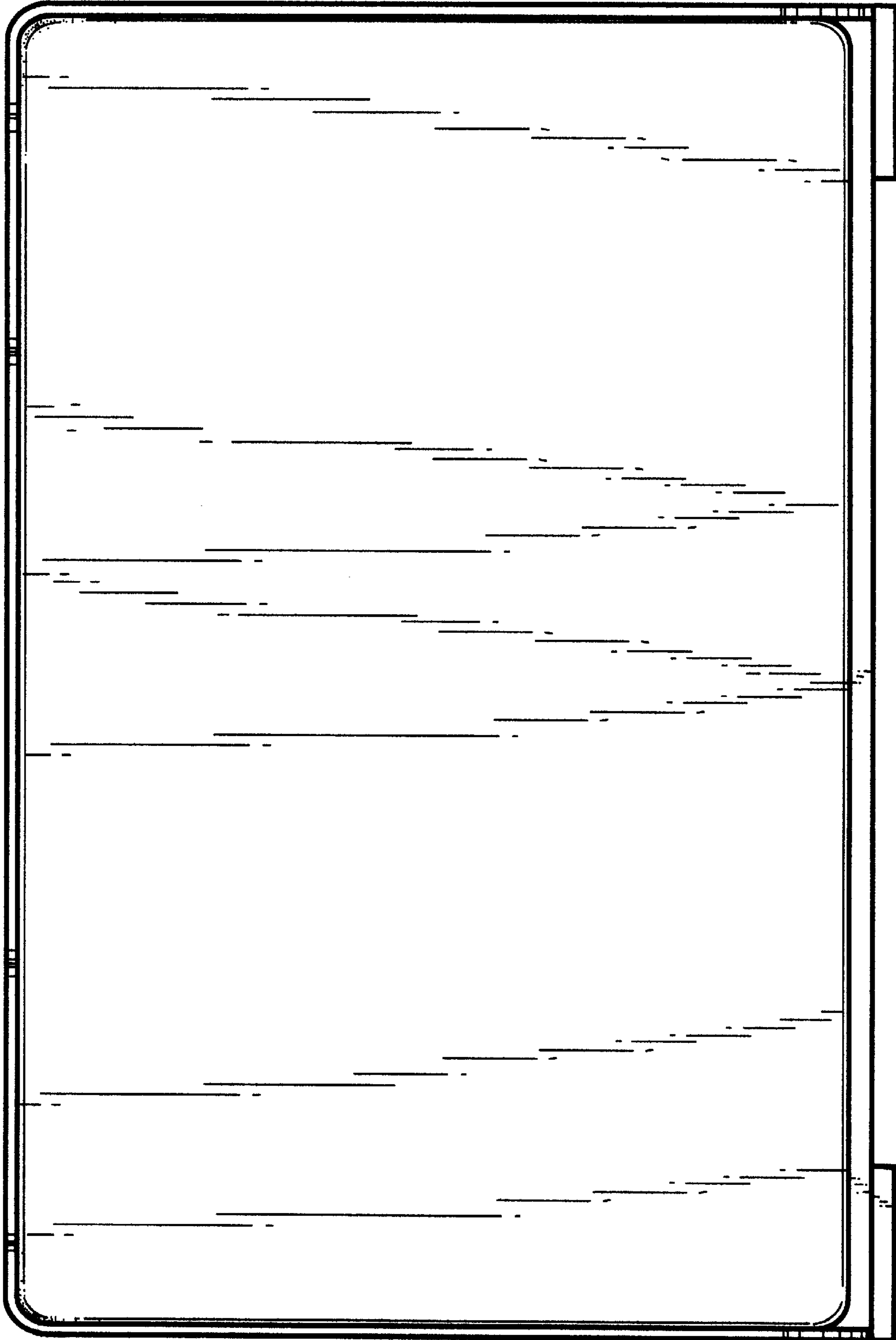

FIGURE 5

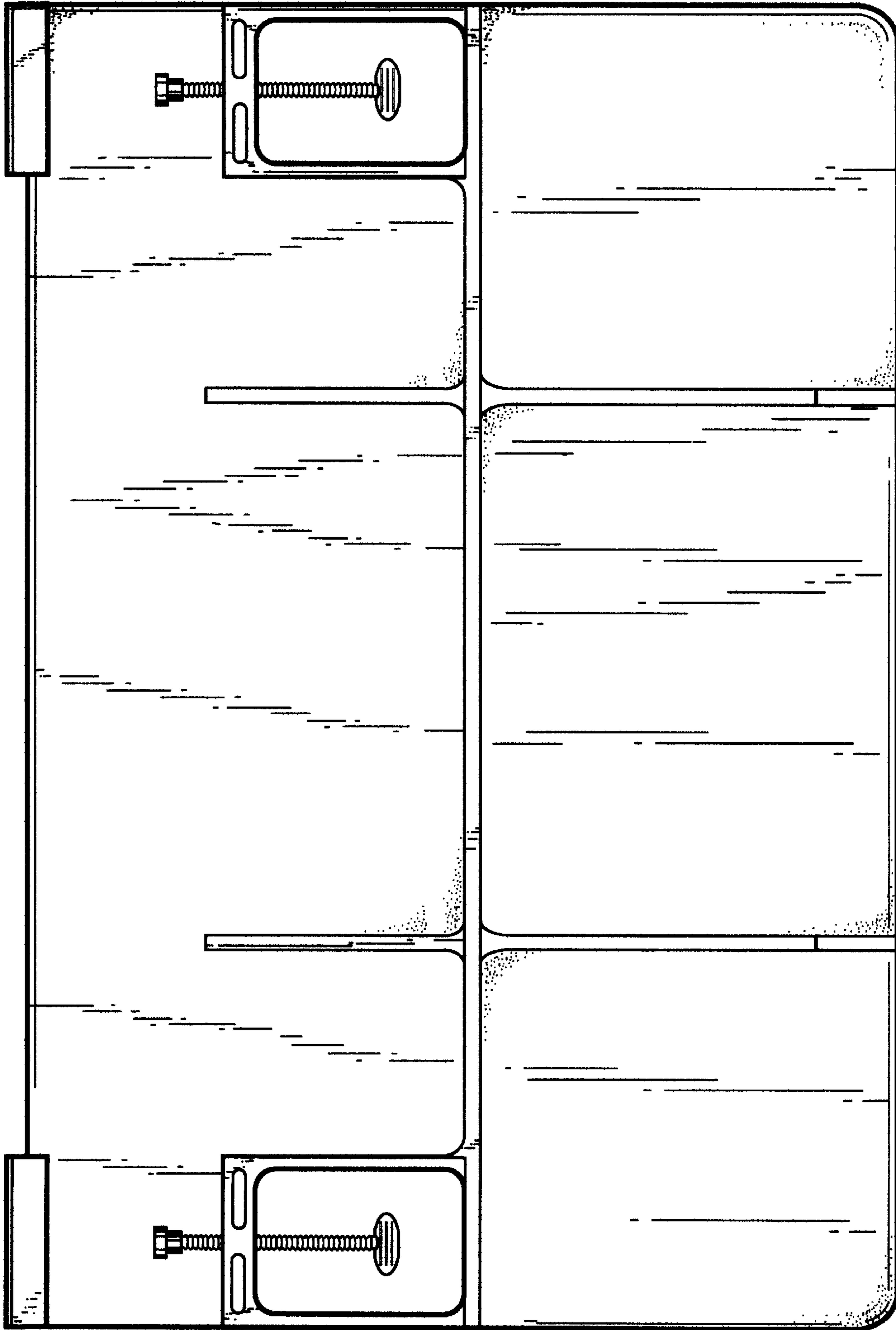

FIGURE 6