



US00D414852S

United States Patent [19] Snook

[11] **Patent Number: Des. 414,852**

[45] **Date of Patent: ** Oct. 5, 1999**

[54] **TOILET SEAT HANDLE**

[76] Inventor: **John Snook**, 2718 Sheridan St.,
Hollywood, Fla. 33020

[**] Term: **14 Years**

[21] Appl. No.: **29/086,201**

[22] Filed: **Apr. 9, 1998**

[51] **LOC (6) Cl. 23-02**

[52] **U.S. Cl. D23/311**

[58] **Field of Search D23/285-311;**
D8/300-307; 4/234-246.1, 661

[56] **References Cited**

U.S. PATENT DOCUMENTS

D. 340,399	10/1993	Paglia	D8/317
D. 340,635	10/1993	Paglia	D8/317
D. 395,078	6/1998	Johnson	D23/311
1,127,919	2/1915	Peper	4/236
5,745,930	5/1998	Pollen	4/246.1

Primary Examiner—Louis S. Zarfaz
Assistant Examiner—Eric Watterson
Attorney, Agent, or Firm—Malloy & Malloy, P.A.

[57] **CLAIM**

The ornamental design for a toilet seat handle, as shown and described.

DESCRIPTION

FIG. 1 is a front perspective view of a toilet seat handle, showing my new design;
FIG. 2 is a top plan view of my design;
FIG. 3 is a bottom view of my design;
FIG. 4 is a right side view of my design, and in phantom a portion of the toilet seat, the left side view being a mirror image thereof;
FIG. 5 is a front elevational view of my design; and,
FIG. 6 is a rear elevational view of my design.
The broken line showing is for illustrative purposes only and forms no part of the claimed design.

1 Claim, 1 Drawing Sheet

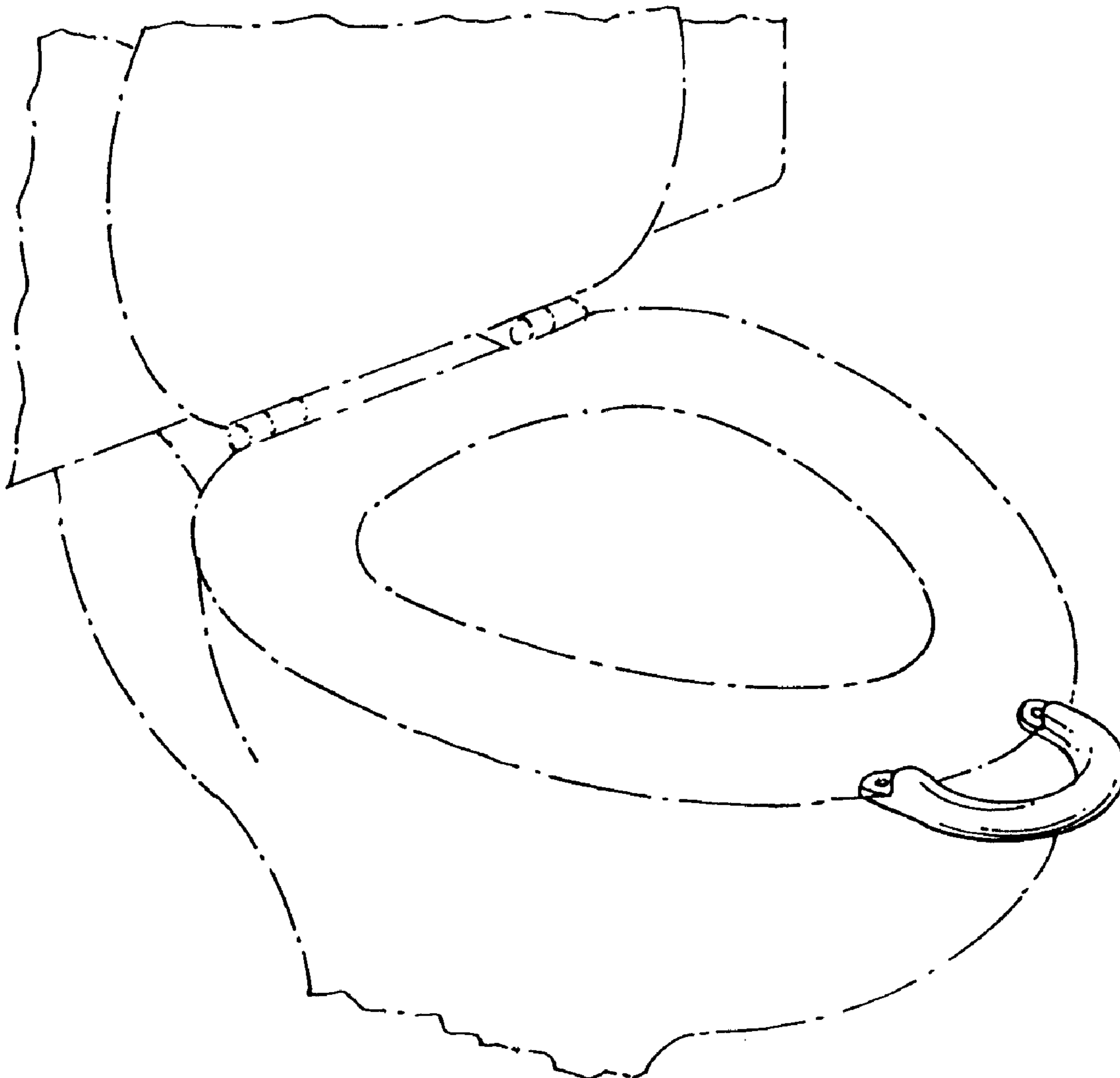

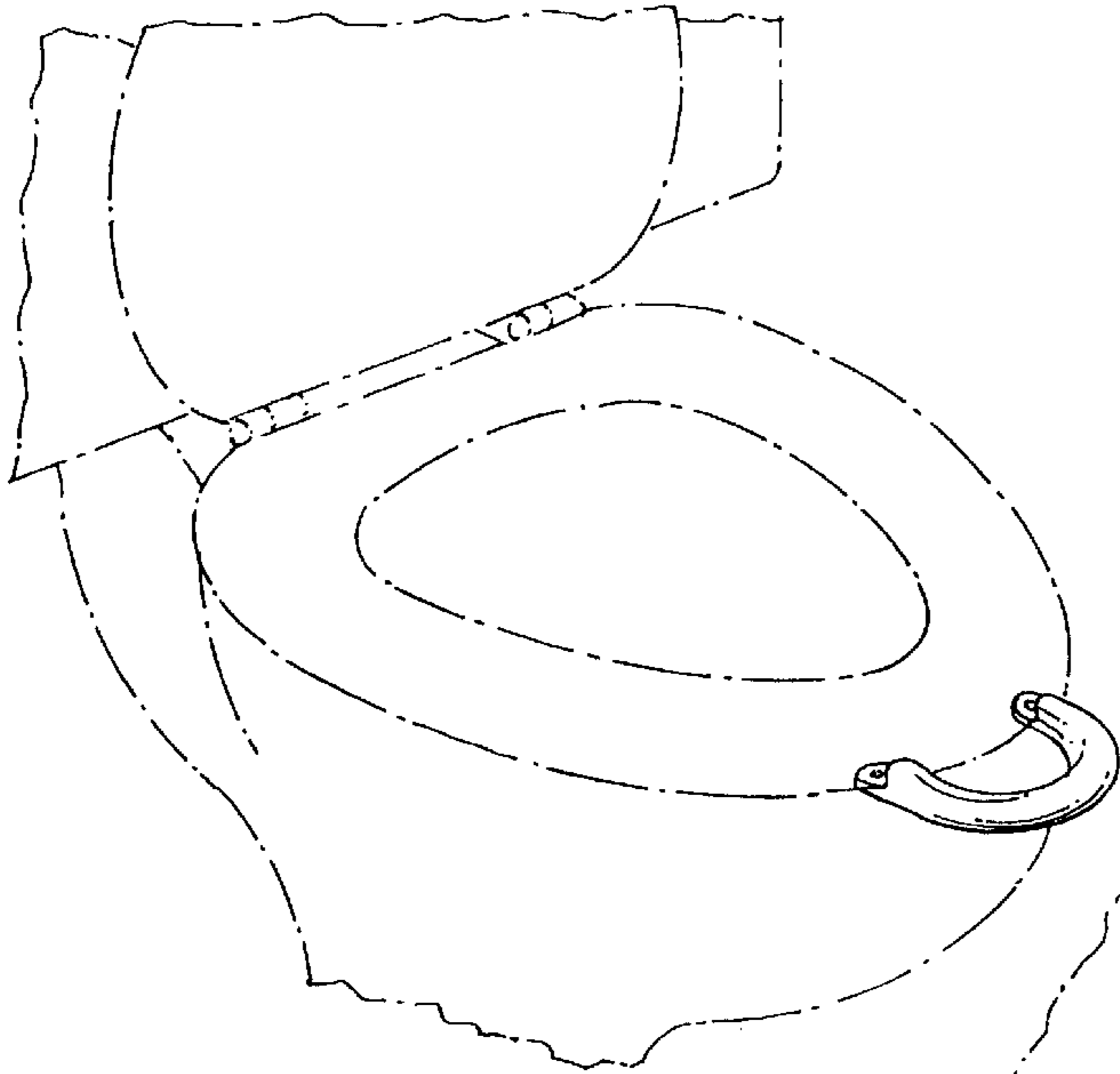

FIG. 1

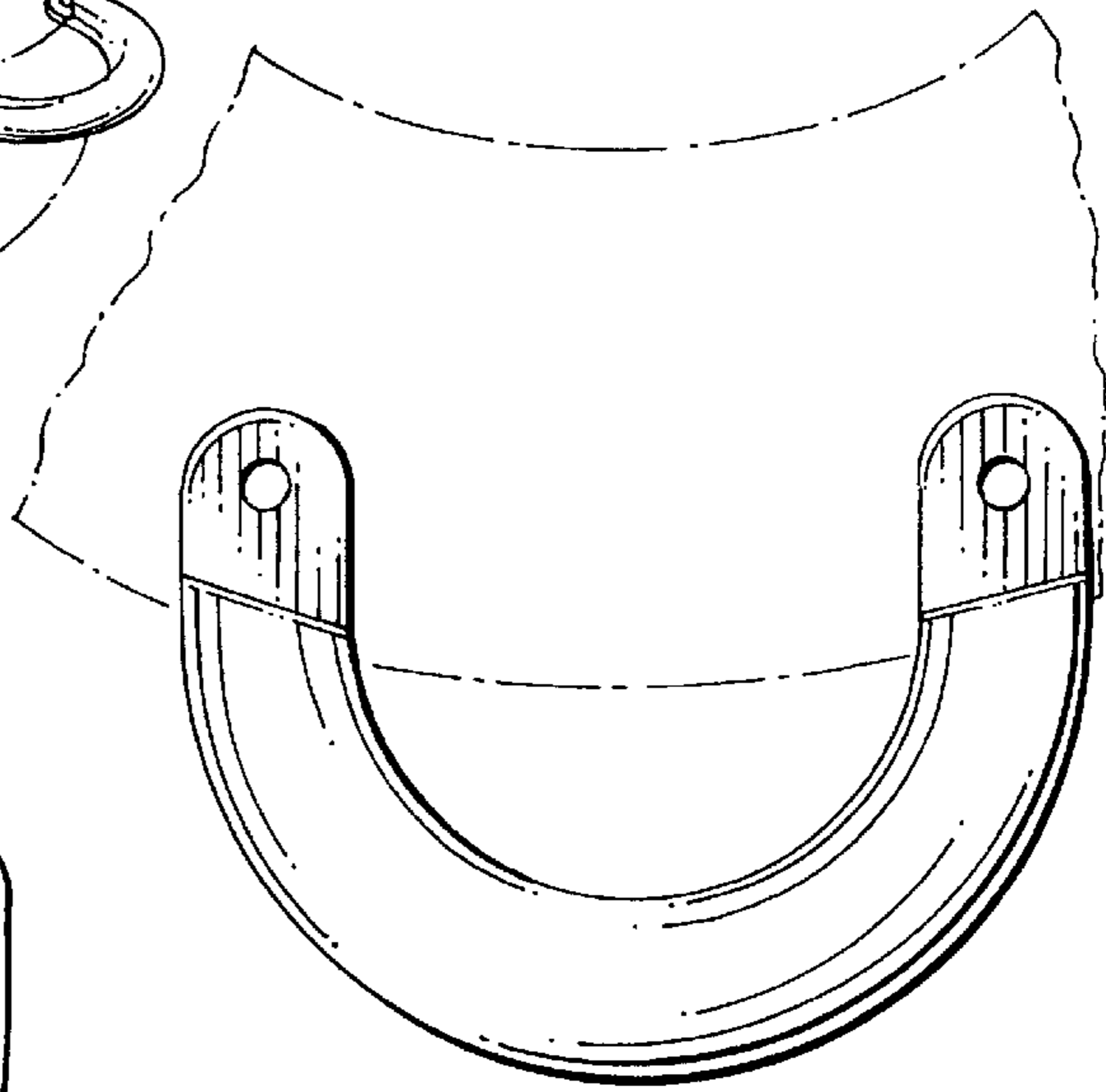

FIG. 2

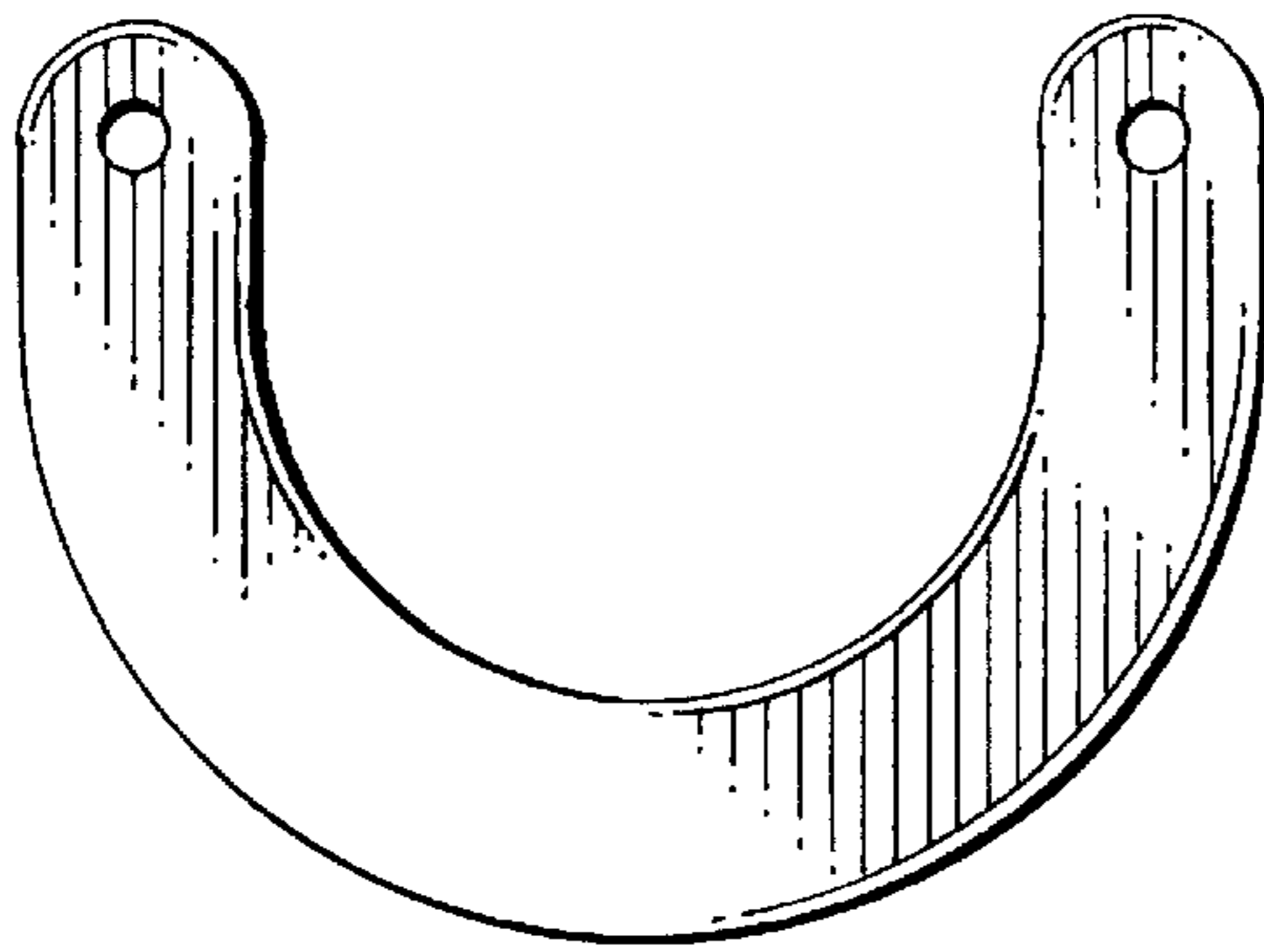

FIG. 3

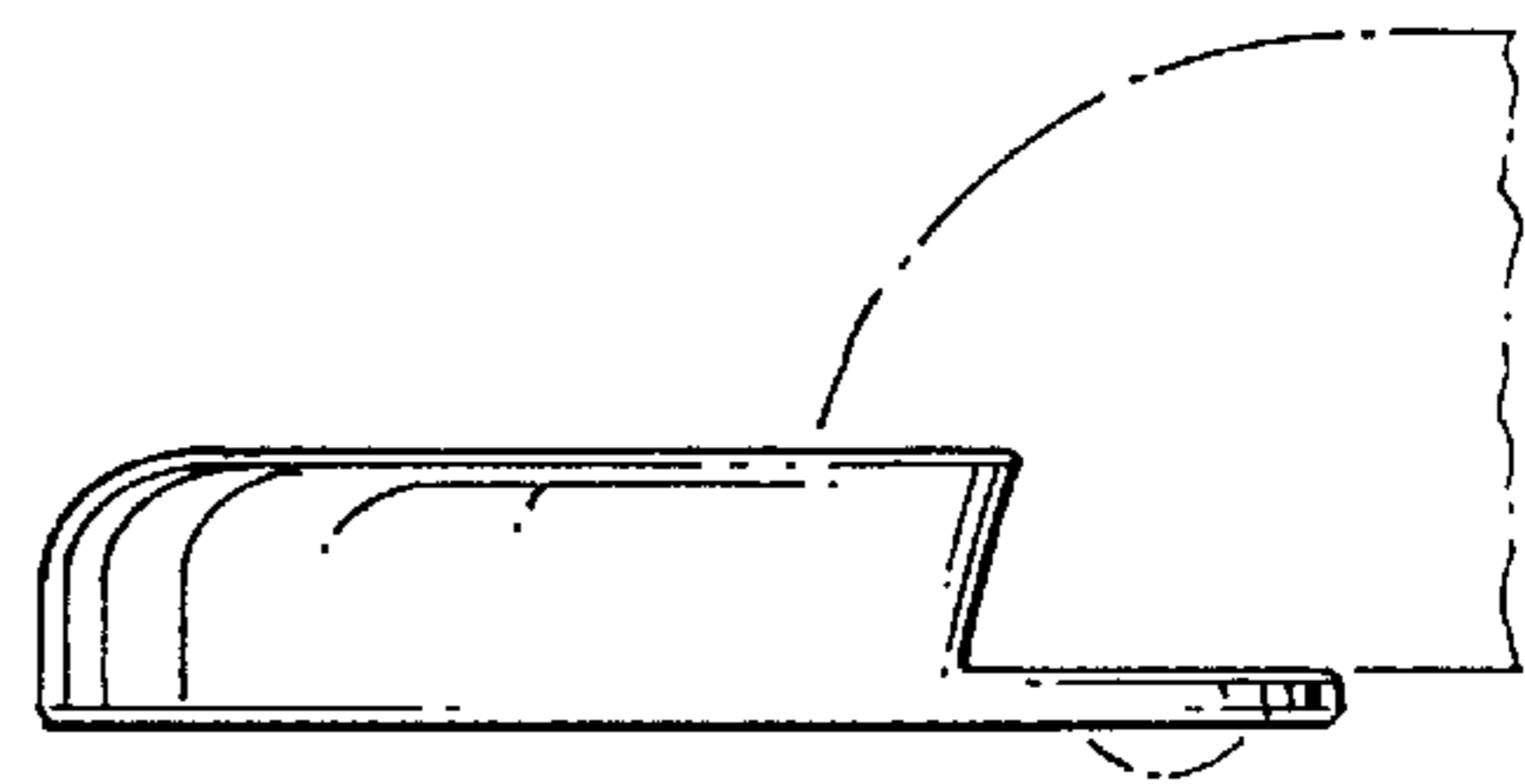

FIG. 4

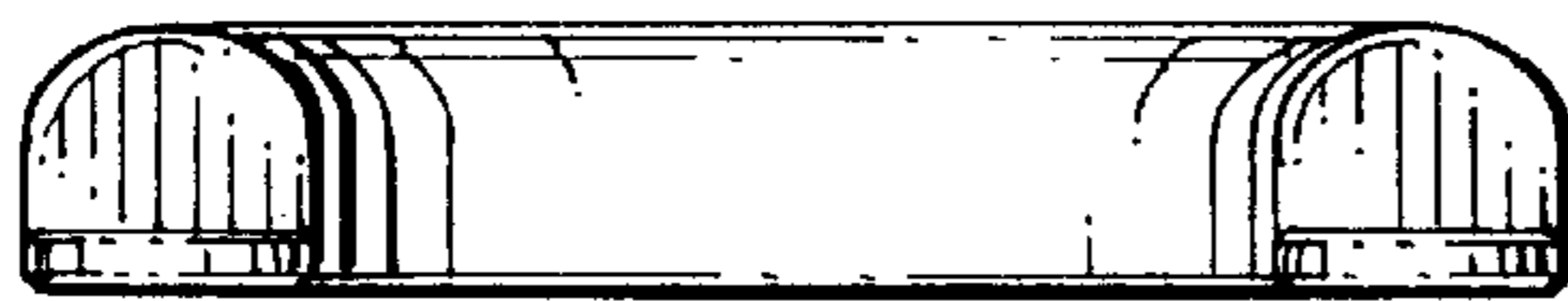

FIG. 5

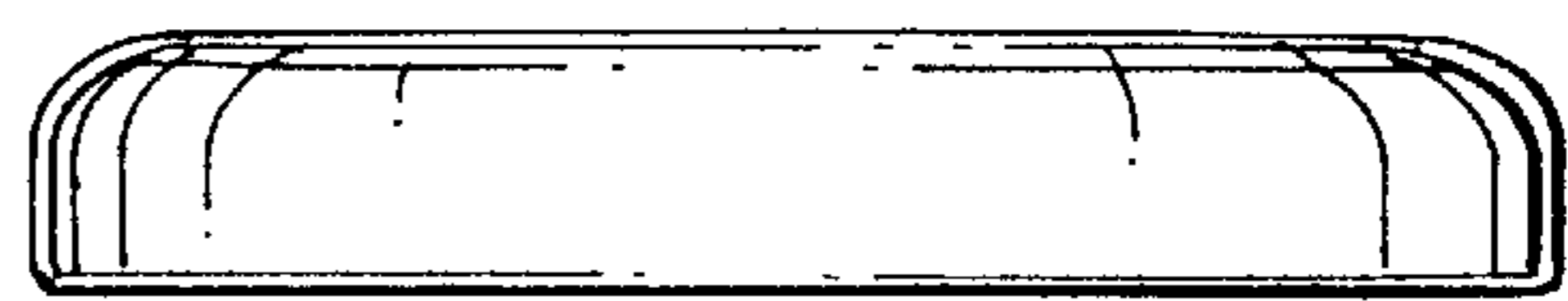

FIG. 6