



US00D414820S

**United States Patent** [19]  
**Kennedy**

[11] **Patent Number: Des. 414,820**

[45] **Date of Patent: \*\* Oct. 5, 1999**

[54] **RATTLE**

[75] Inventor: **Kathleen A. Kennedy**, Denver, Colo.

[73] Assignee: **U S West, Inc.**, Denver, Colo.

[\*\*] Term: **14 Years**

[21] Appl. No.: **29/097,011**

[22] Filed: **Nov. 25, 1998**

D. 231,791	6/1974	Sidman .....	D21/406
D. 356,122	3/1995	Bodo .....	D21/406
2,380,368	7/1945	Desmond .....	446/419
2,618,893	11/1952	Gelardin et al. ....	446/419
3,460,830	8/1969	Barlow et al. ....	446/419 X

*Primary Examiner*—Dominic Simone  
*Attorney, Agent, or Firm*—Holme Roberts & Owen

[57] **CLAIM**

The ornamental design for a rattle, as shown.

**Related U.S. Application Data**

[62] Division of application No. 29/090,376, Jun. 29, 1998.

[51] **LOC (6) Cl.** ..... **21-01**

[52] **U.S. Cl.** ..... **D21/406**

[58] **Field of Search** ..... D21/405, 406;  
D17/22; 446/397, 418, 419

**DESCRIPTION**

FIG. 1 is a perspective view of a rattle, showing my new design;

FIG. 2 is a front elevational view thereof, the right and left sides and rear being identical;

FIG. 3 is a top plan view thereof;

FIG. 4 is a bottom plan view thereof;

FIG. 5 is a cross-sectional view thereof;

FIG. 6 is a front elevational view thereof in an alternate position; and,

FIG. 7 is a cross sectional view of FIG. 6.

[56] **References Cited**

**U.S. PATENT DOCUMENTS**

D. 141,810	7/1945	Delano .....	D21/406
D. 151,599	11/1948	Colm .....	D21/406

**1 Claim, 6 Drawing Sheets**

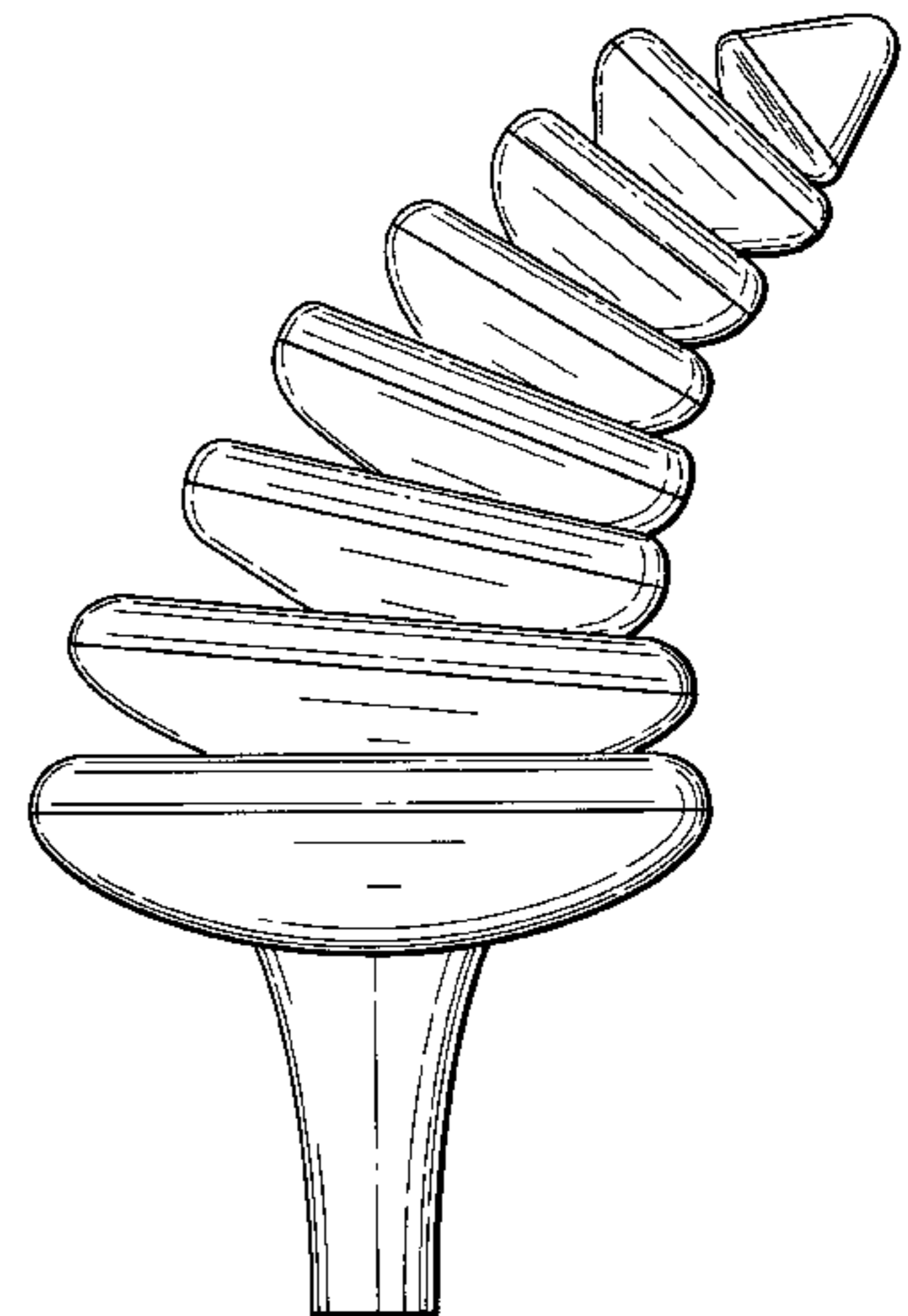
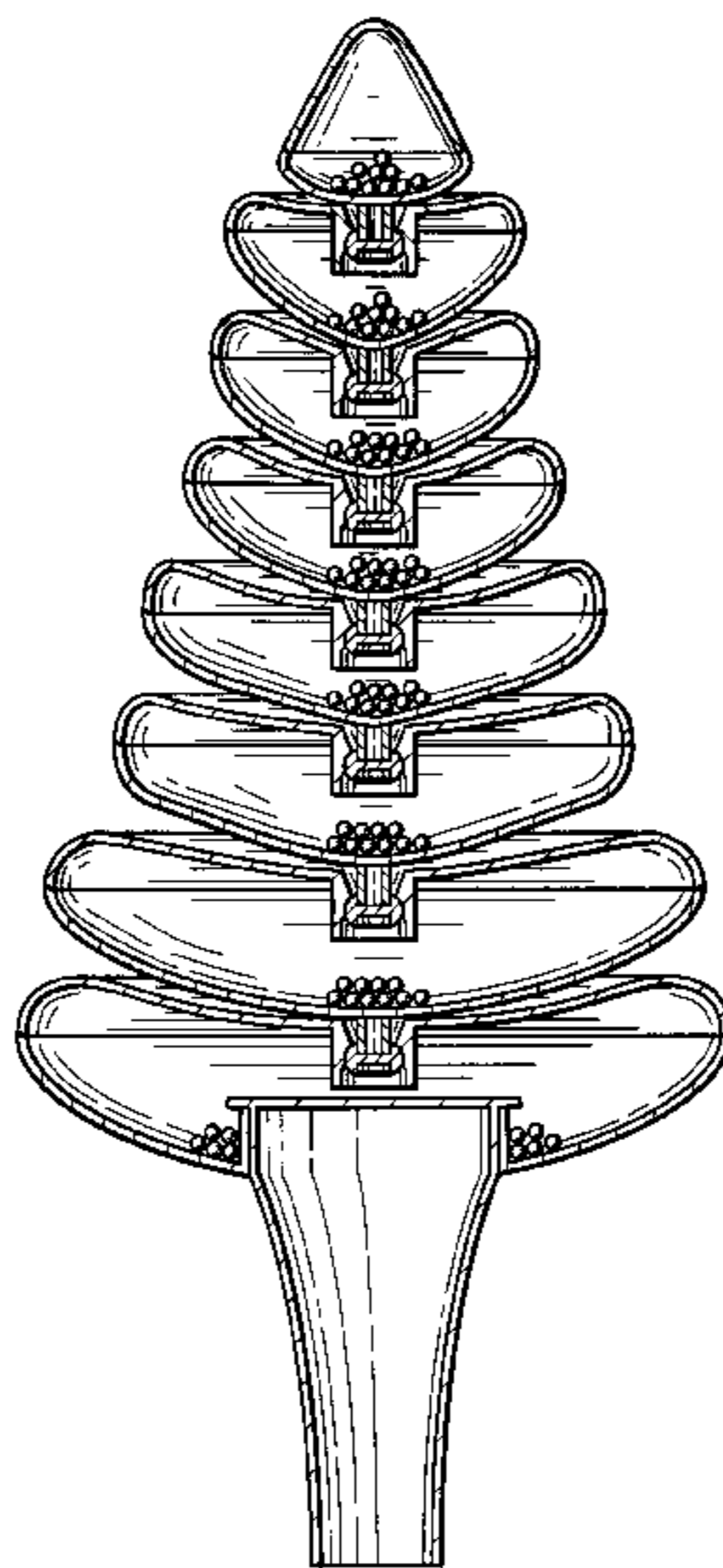
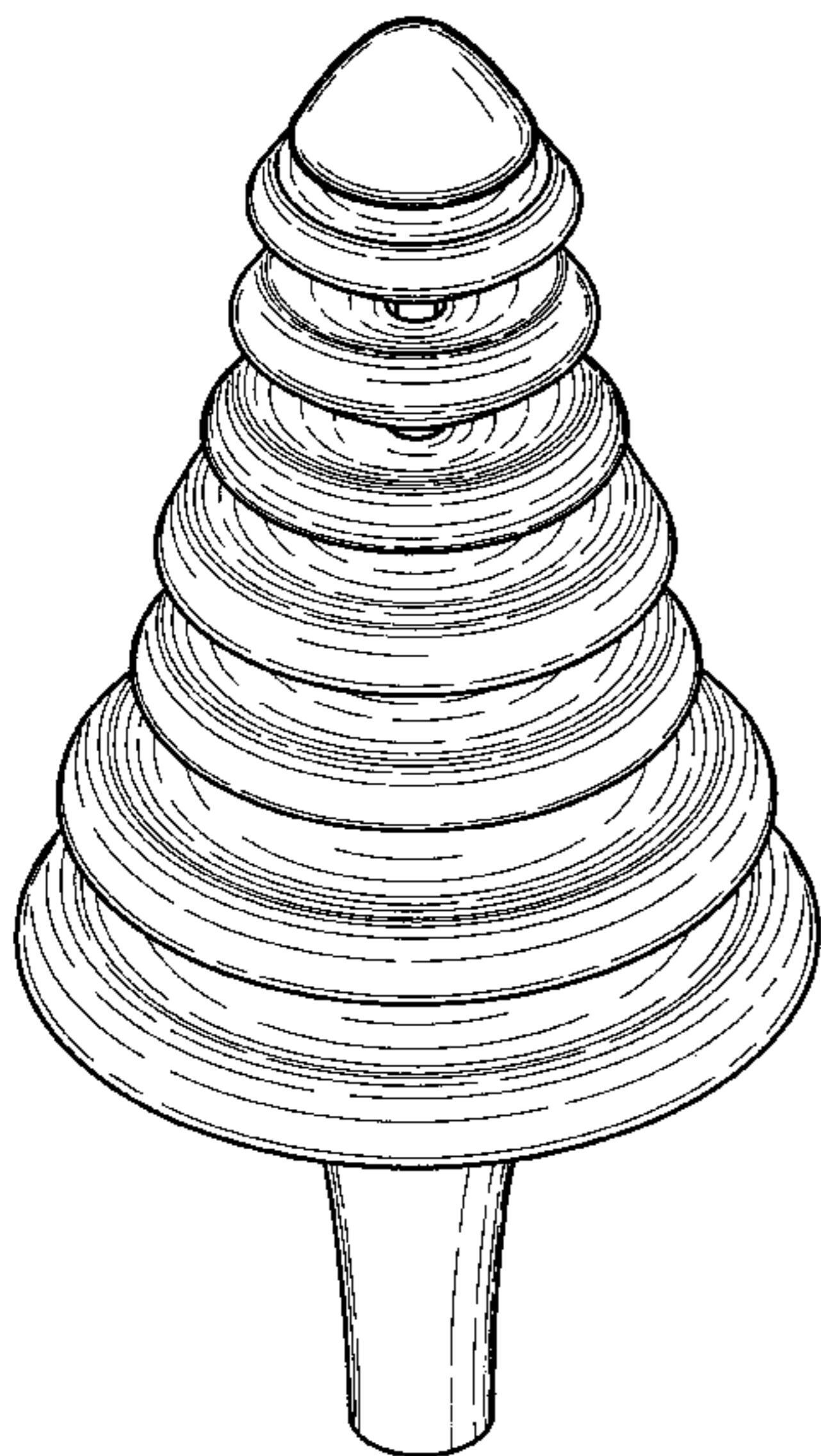

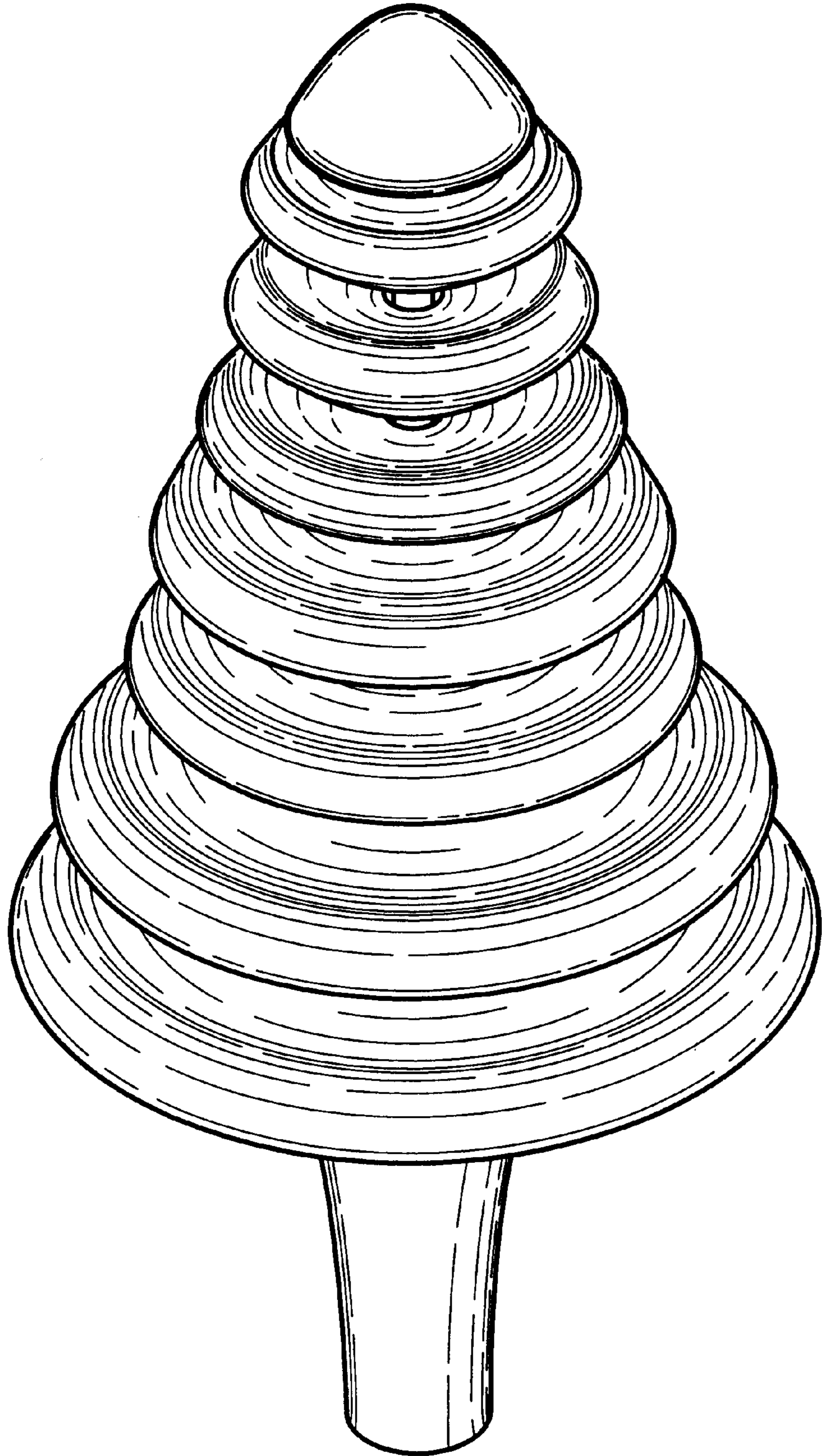

FIG. 1

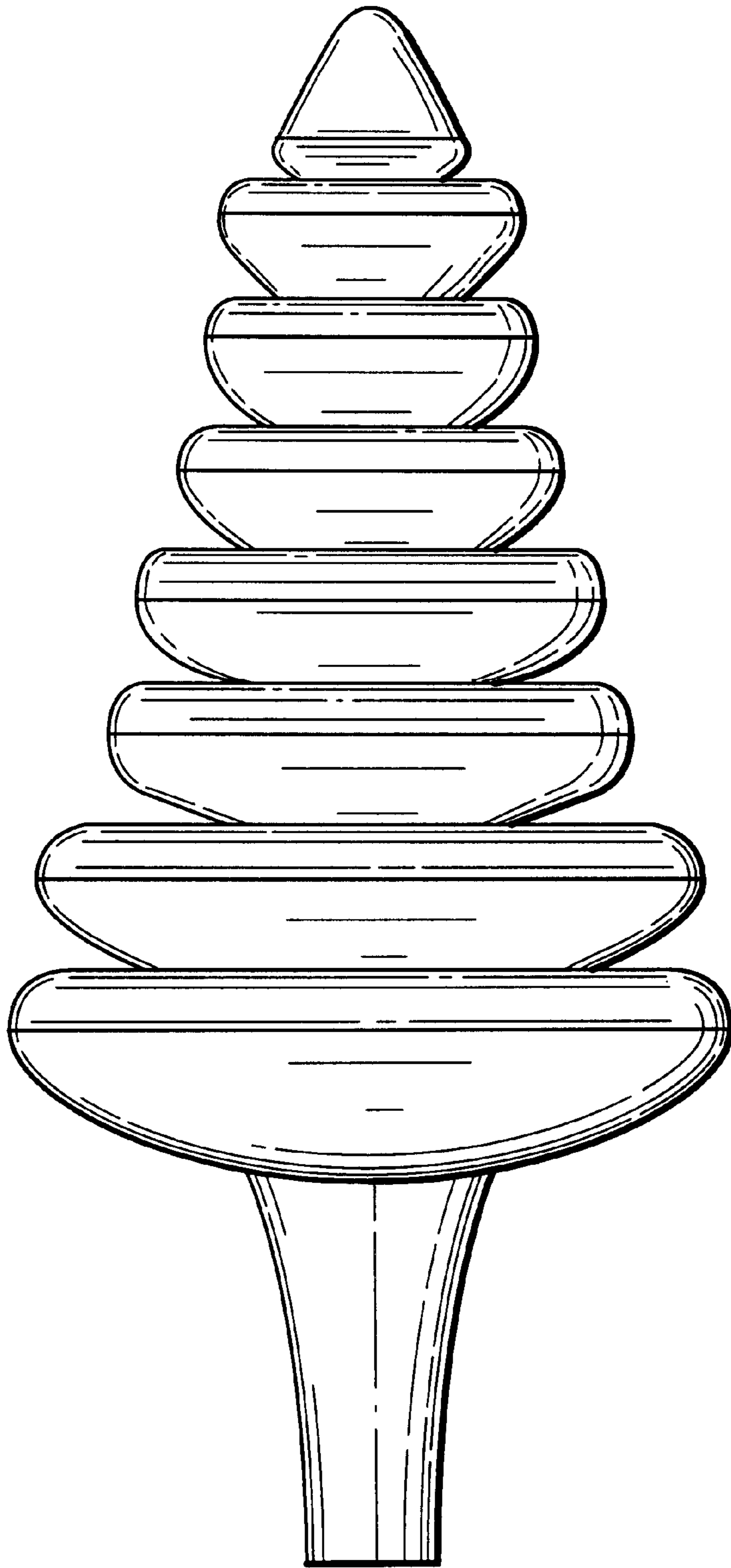

FIG.2

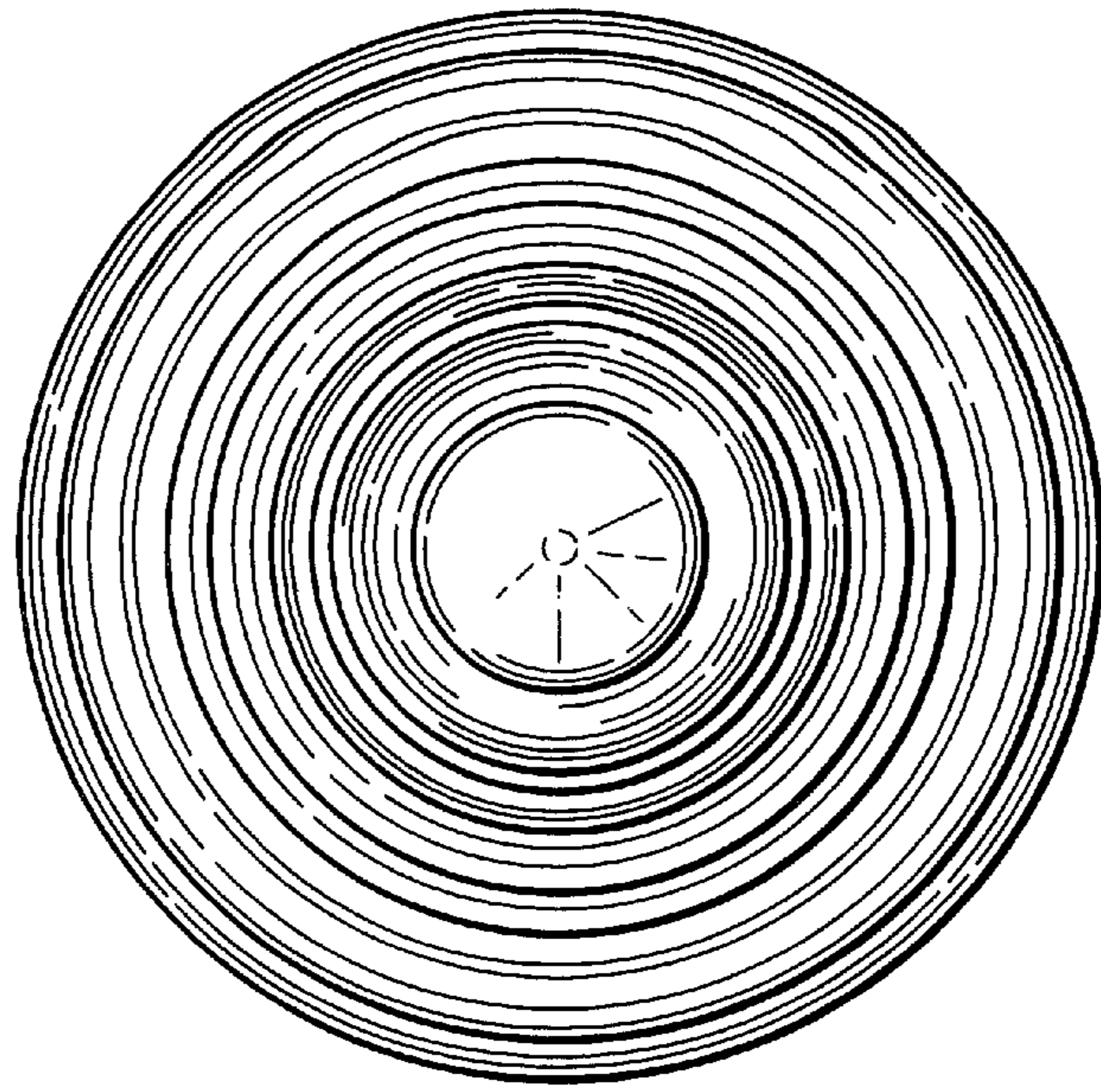

FIG. 3

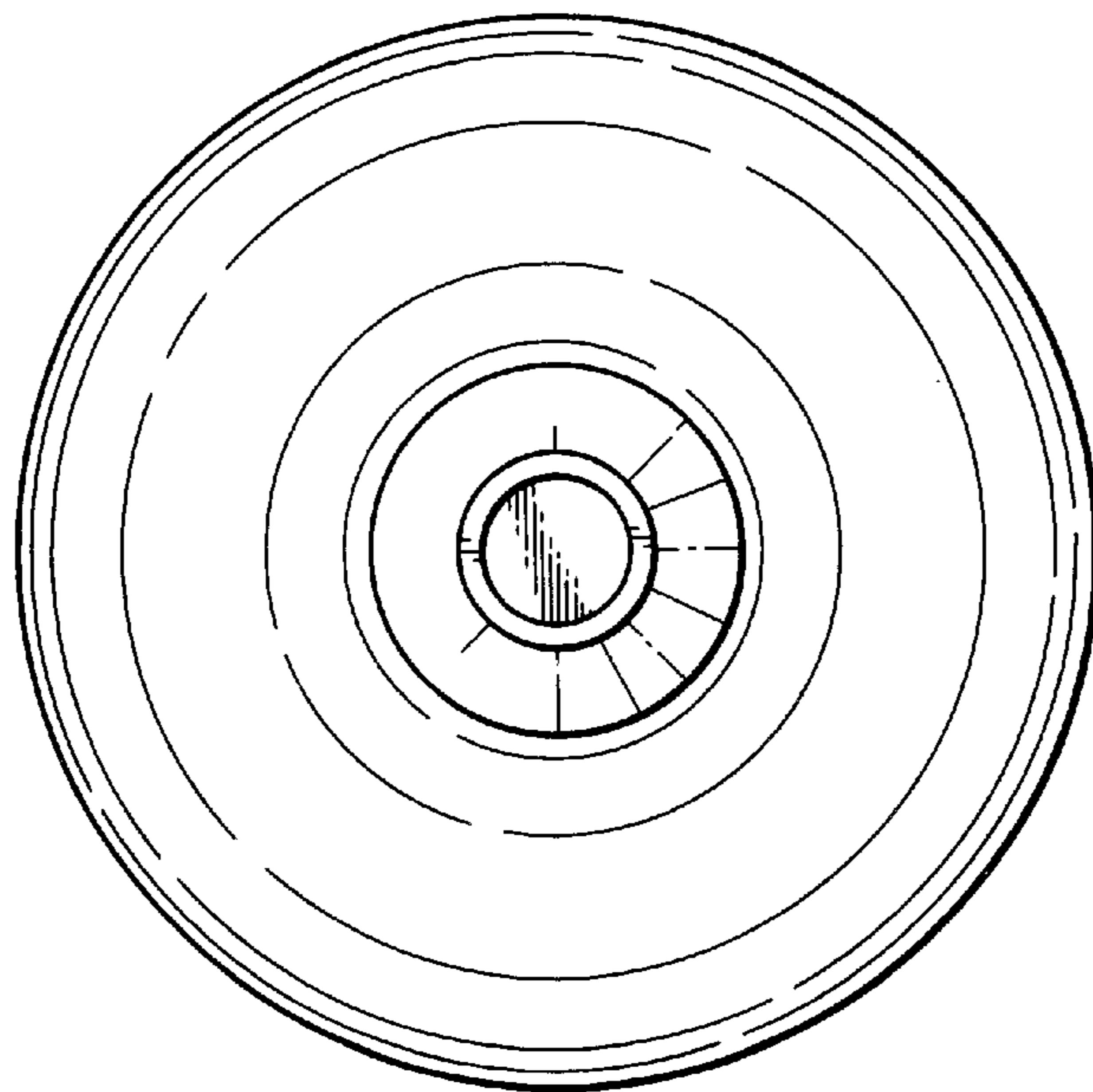

FIG. 4

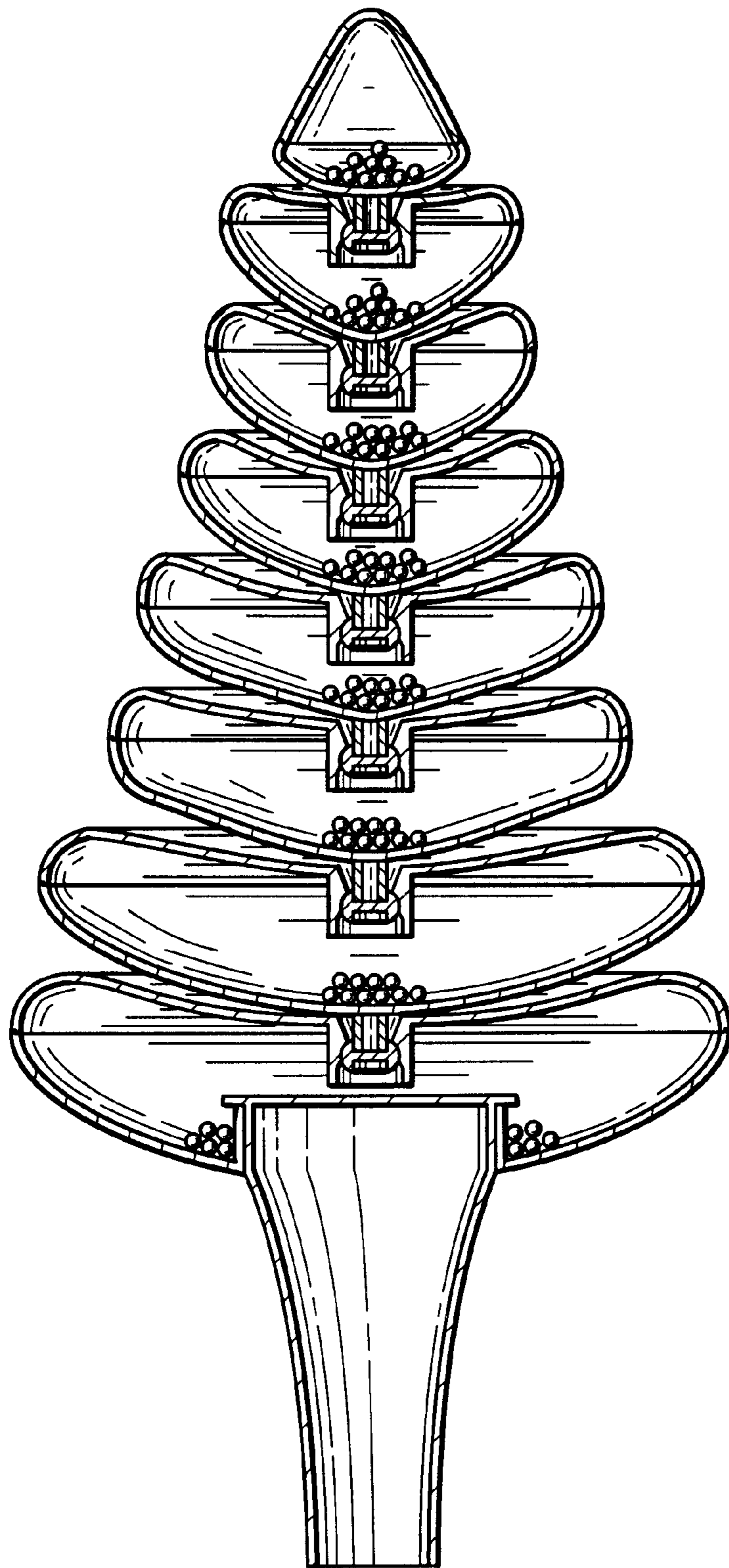

FIG. 5

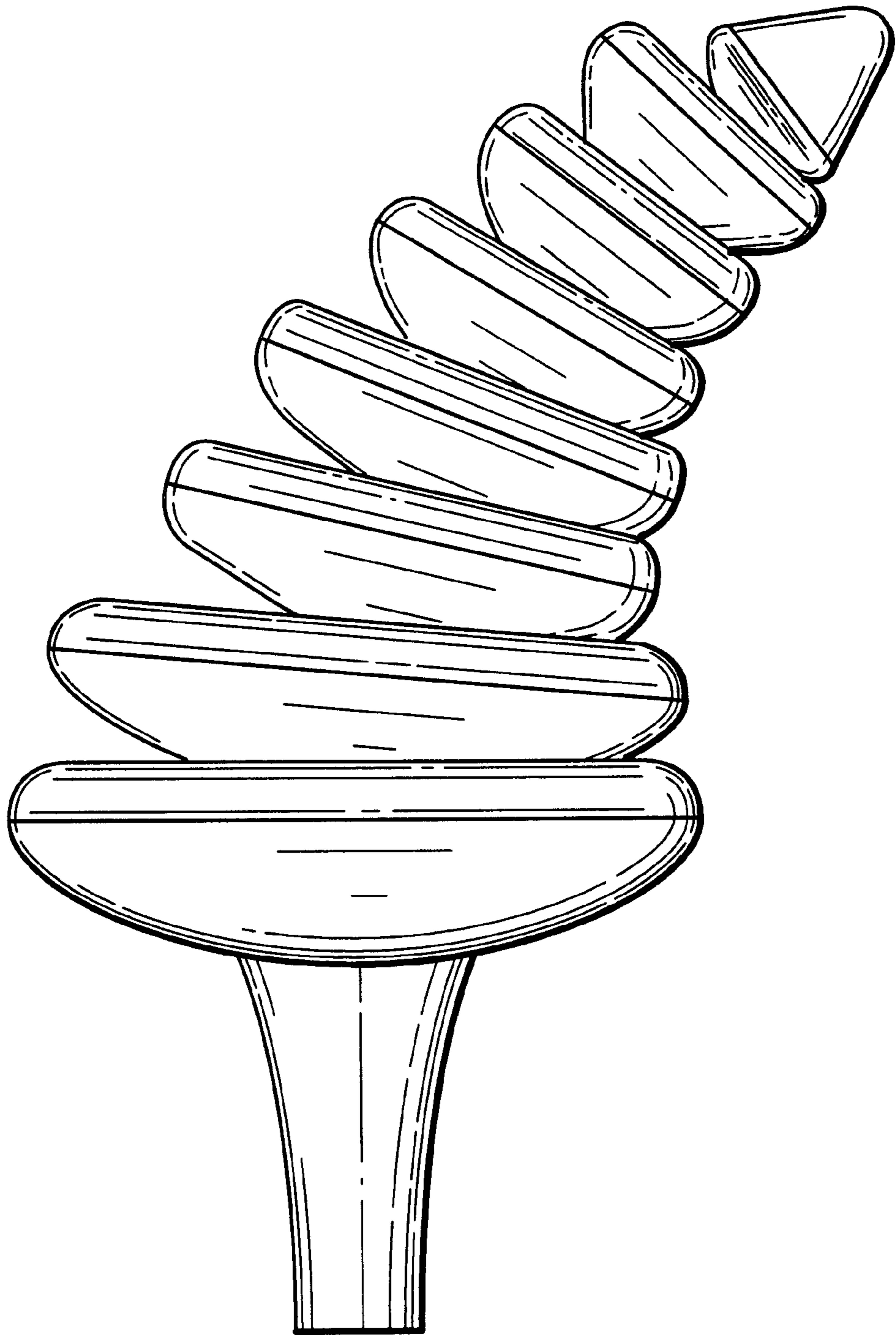

FIG.6

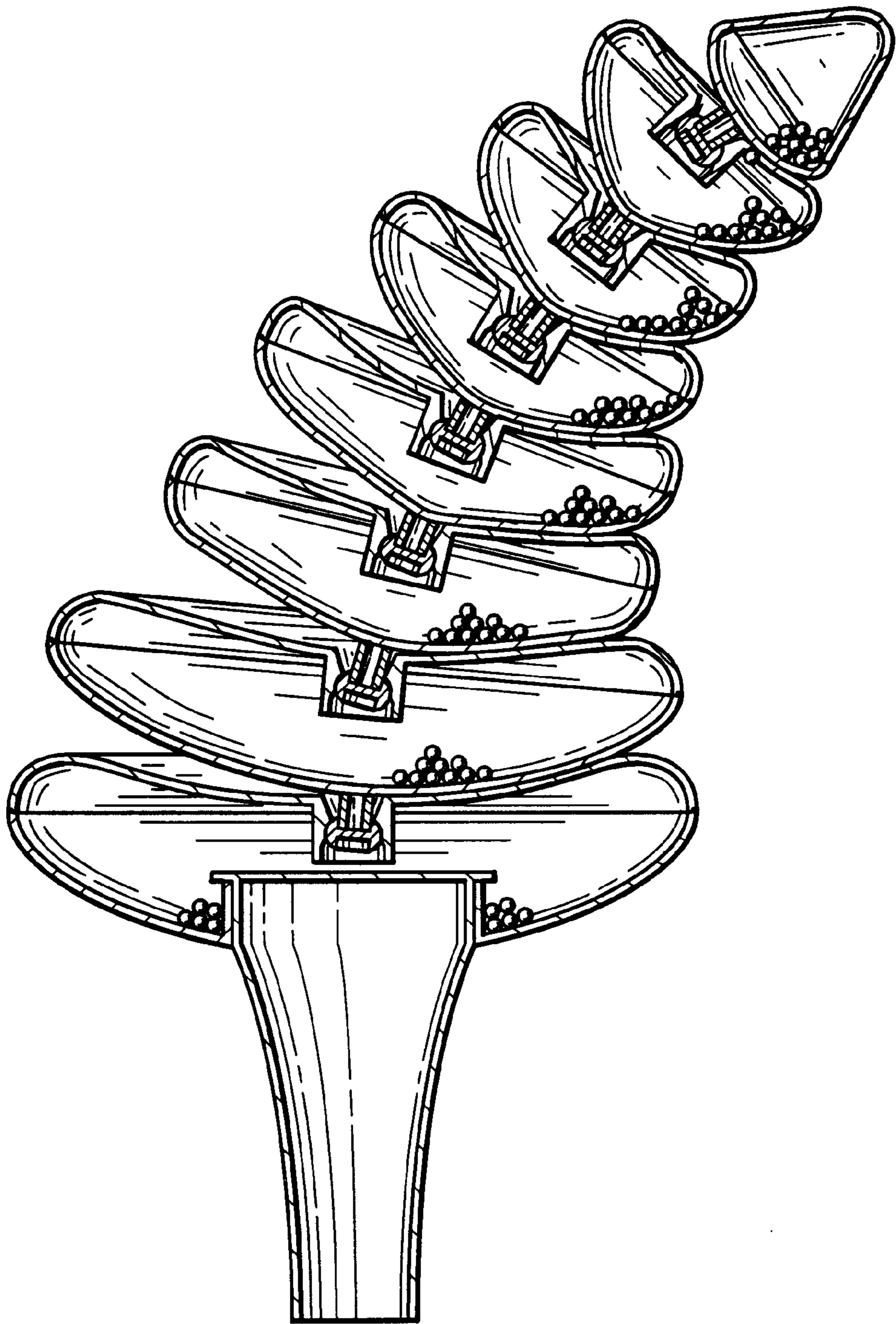

FIG.7