



US00D414784S

United States Patent [19] Maeda

[11] **Patent Number: Des. 414,784**
[45] **Date of Patent: ** Oct. 5, 1999**

[54] **LAWN TRACTOR COVER**

[75] Inventor: **Joji Maeda**, Hohya, Japan

[73] Assignee: **Honda Giken Kogyo Kabushiki Kaisha**, Tokyo, Japan

[**] Term: **14 Years**

[21] Appl. No.: **29/073,613**

[22] Filed: **Jul. 11, 1997**

[30] **Foreign Application Priority Data**

Jan. 14, 1997 [JP] Japan 9-622

[51] **LOC (6) Cl.** **15-03**

[52] **U.S. Cl.** **D15/17**

[58] **Field of Search** D15/10, 14-17;
56/11.8, 13.4, 16.7, 17.4, 17.5, 202, 255,
320.1, 320.2

[56] **References Cited**

U.S. PATENT DOCUMENTS

D. 177,961	6/1956	Butler	D15/14
D. 183,733	10/1958	Gale	D15/17
D. 226,574	3/1973	Fernandez et al.	D15/17
D. 248,761	8/1978	Uhlinger et al.	D15/17
D. 260,149	8/1981	Harris	D15/17
D. 352,043	11/1994	Davies, III	D15/17

OTHER PUBLICATIONS

Horticulture Magazine, May 1993. p. 49, Ryobi mower.
Hechinger 1997 Lawn & Garden Power Equipment Catalog.
p. 12, Yard Machine Push Mower.

Primary Examiner—Sandra L. Morris
Attorney, Agent, or Firm—Blank Rome Comisky &
McCauley LLP

[57] **CLAIM**

The ornamental design for a lawn tractor cover, as shown and described.

DESCRIPTION

FIG. 1 is a front perspective view of the lawn tractor cover showing my new design;
FIG. 2 is a rear perspective view of FIG. 1;
FIG. 3 is a front elevational view of FIG. 1;
FIG. 4 is a rear elevational view of FIG. 1;
FIG. 5 is a left side elevational view of FIG. 1;
FIG. 6 is a right side elevational view of FIG. 1;
FIG. 7 is a top plan view of FIG. 1;
FIG. 8 is a bottom plan view of FIG. 1; and,
FIG. 9 is a reduced perspective view thereof, the broken line showing of the lawn mower is for illustrative purposes only, and forms no part of the claimed design.

1 Claim, 4 Drawing Sheets

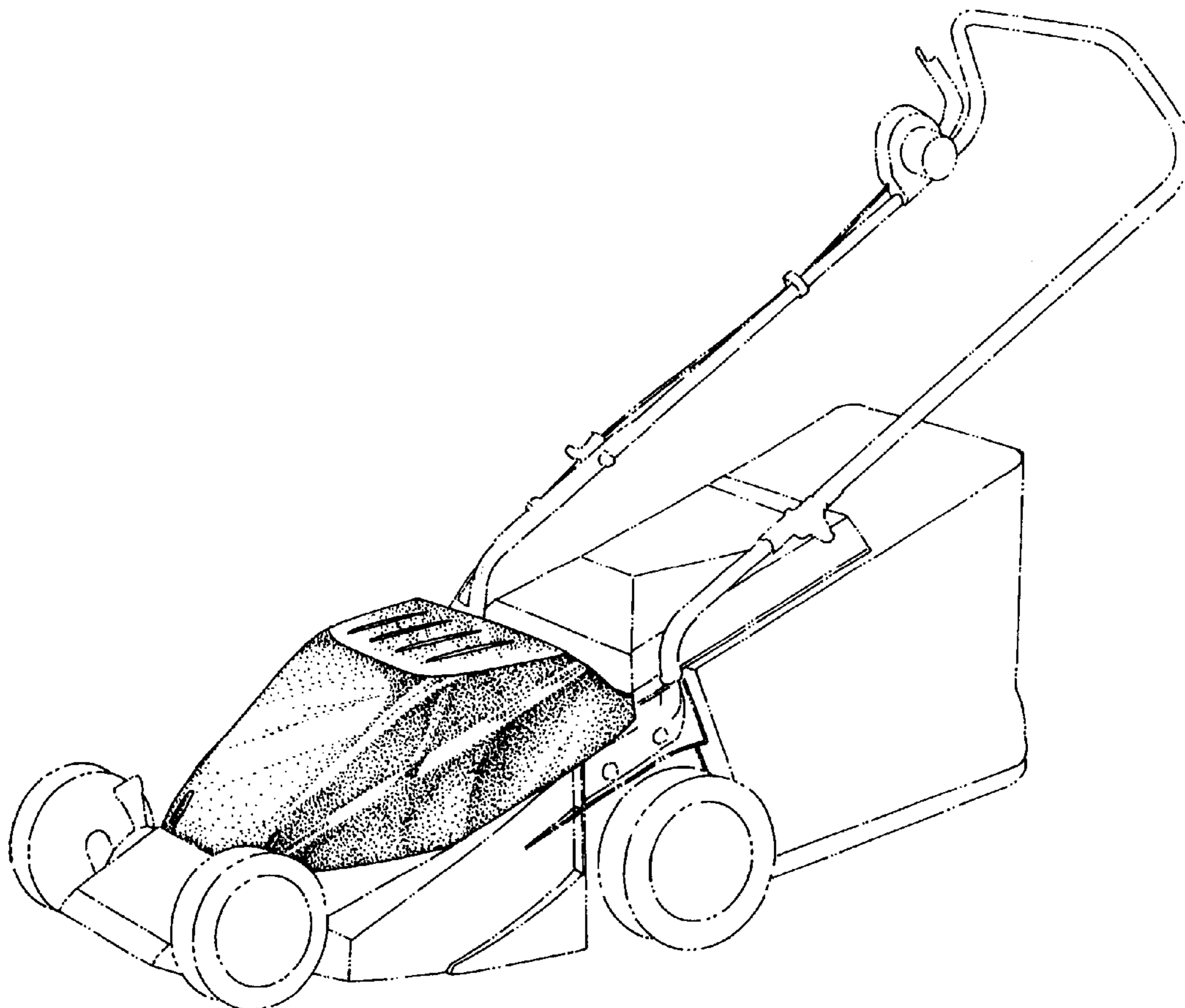

FIG. 1

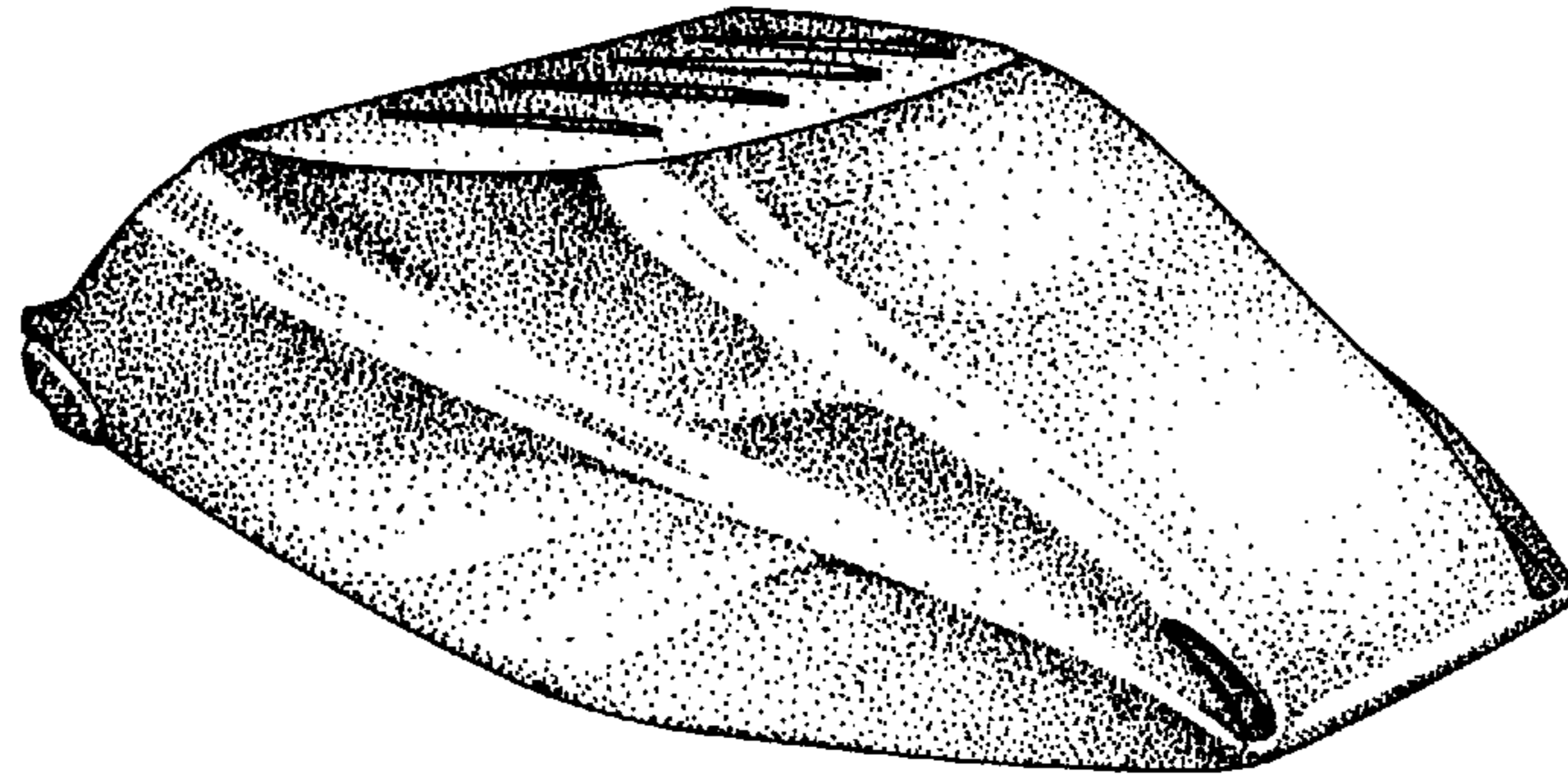

FIG. 2

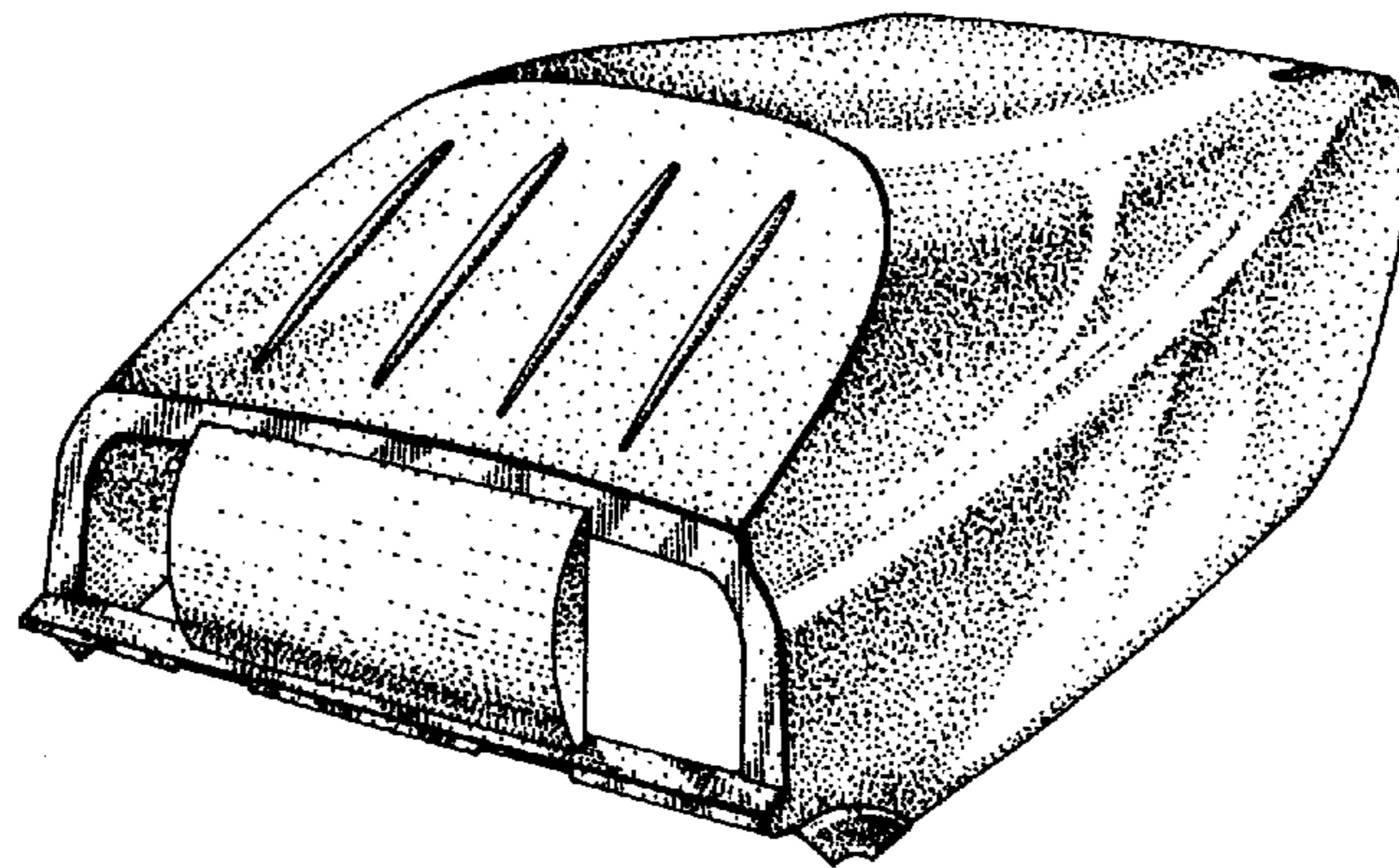

FIG. 3

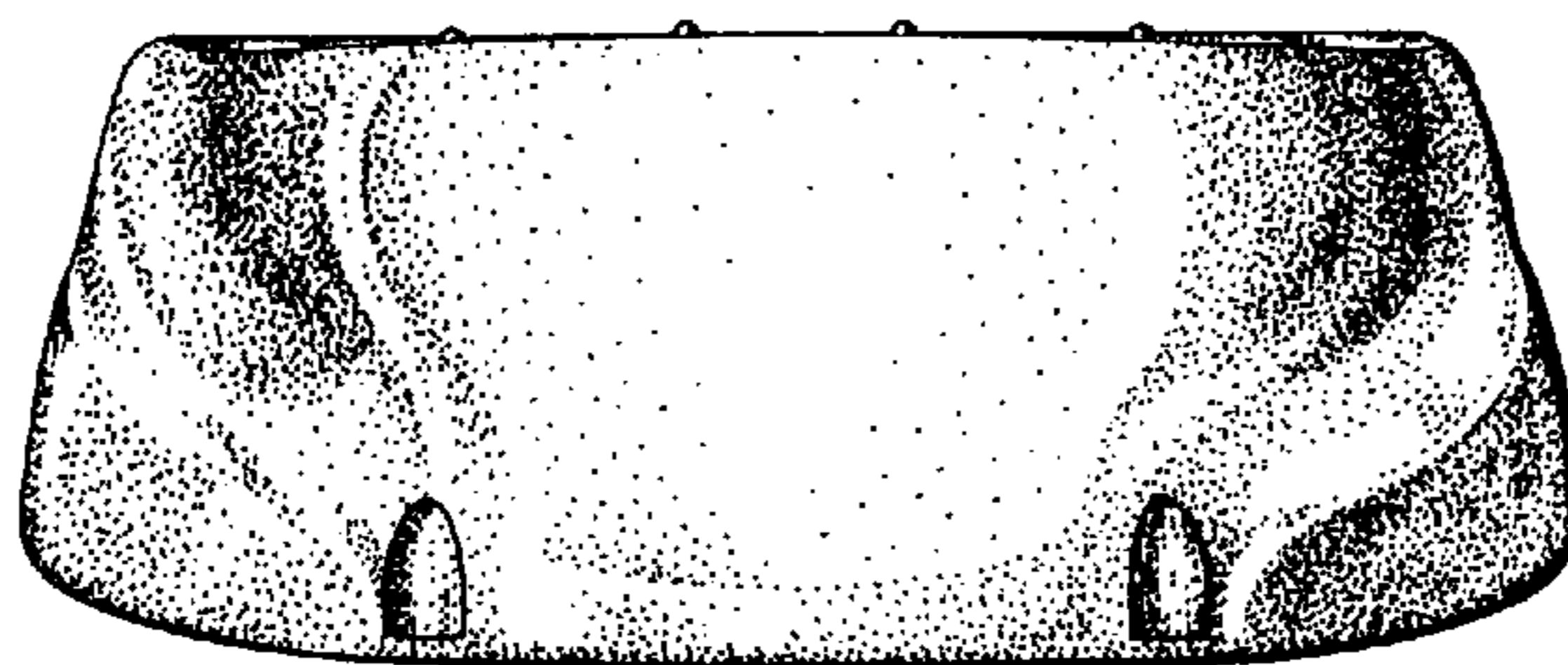

FIG. 4

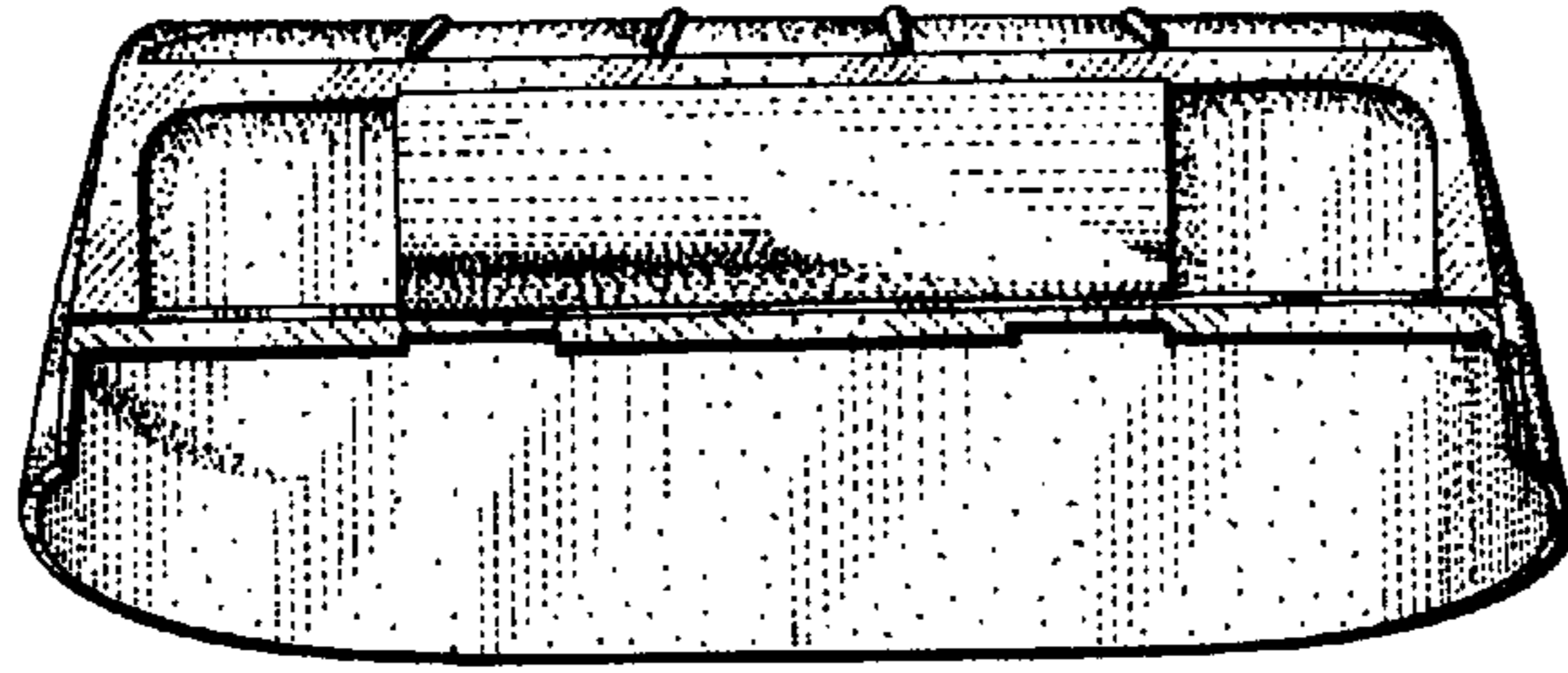

FIG. 5

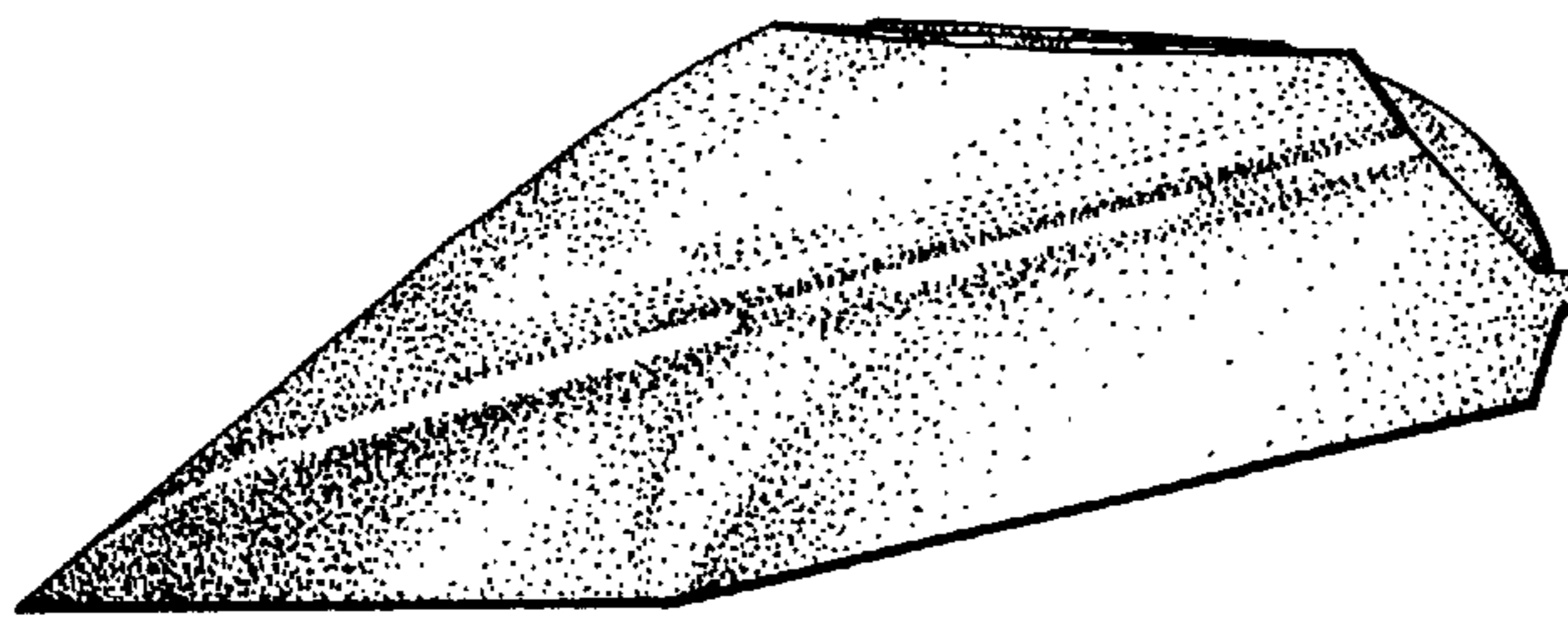

FIG. 6

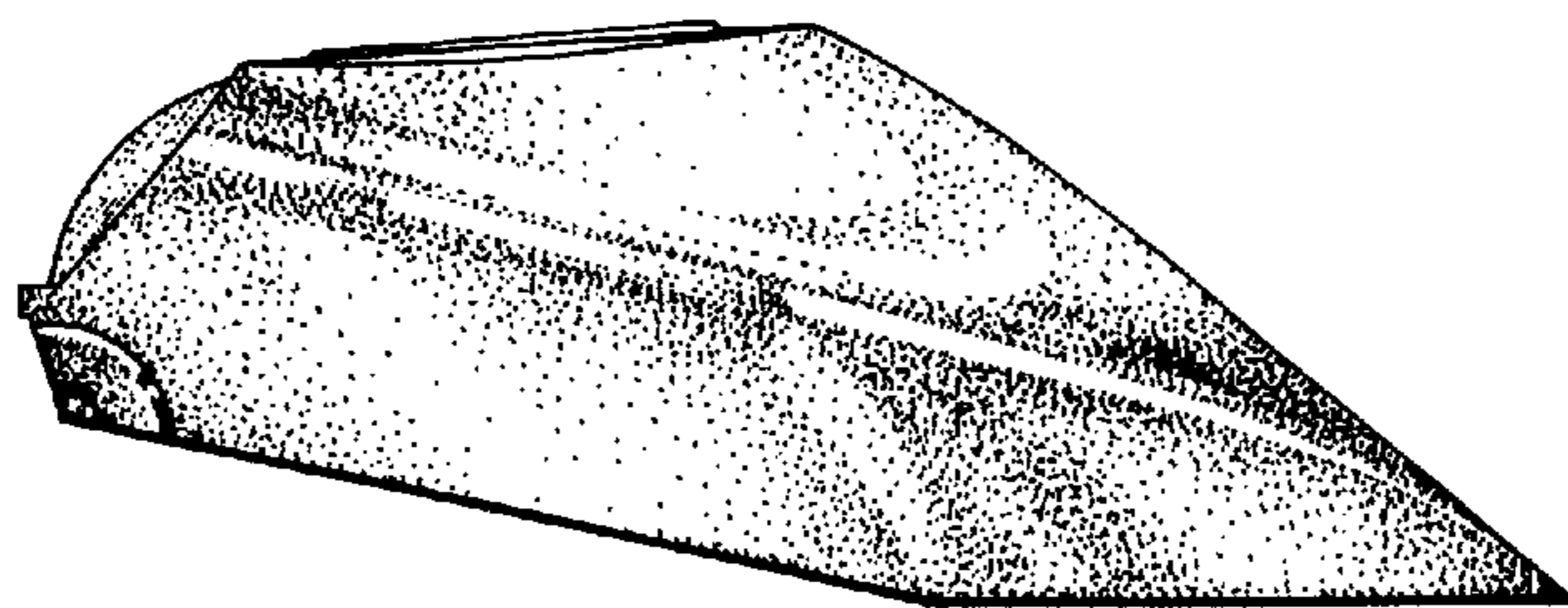

FIG. 7

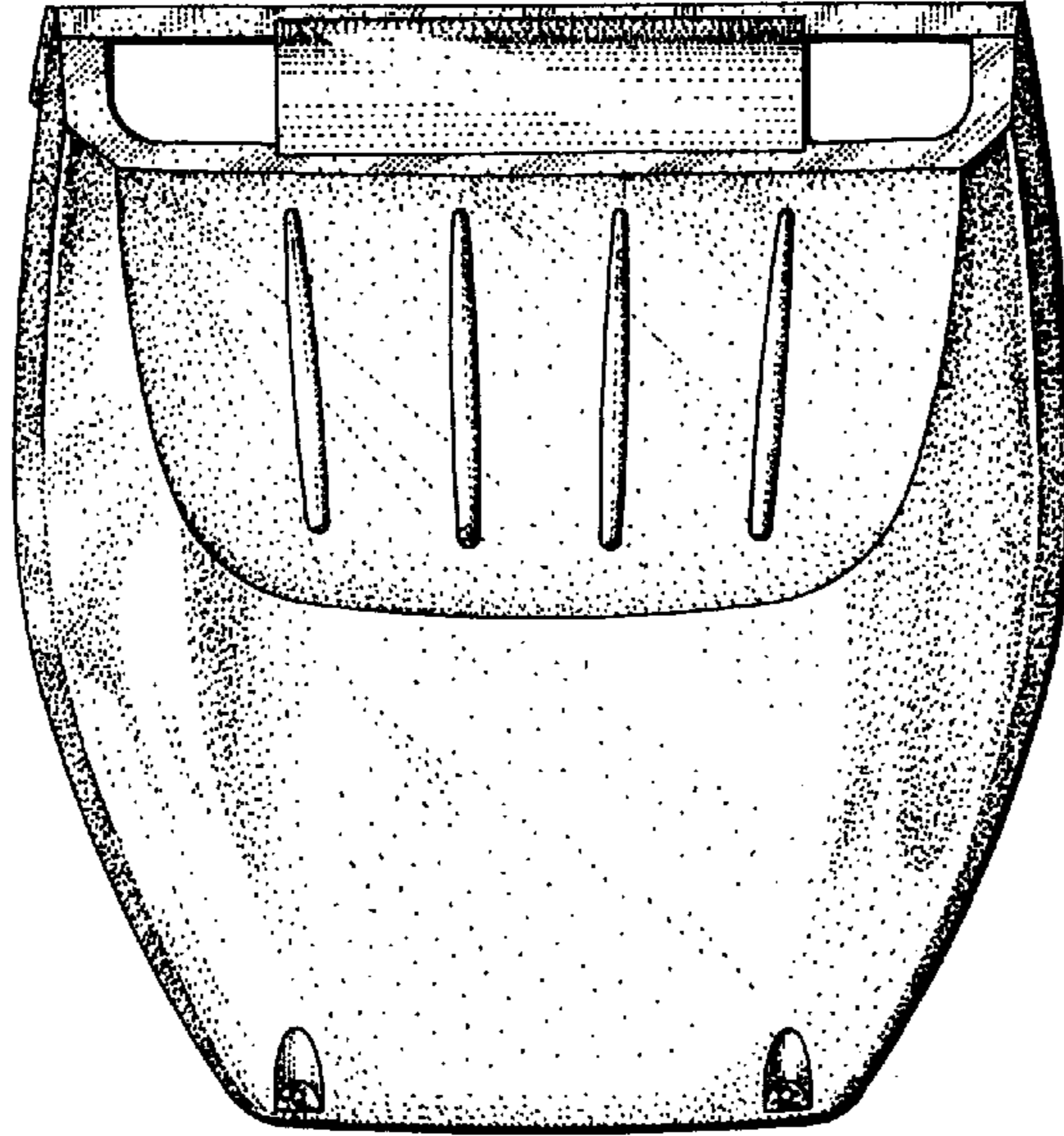

FIG. 8

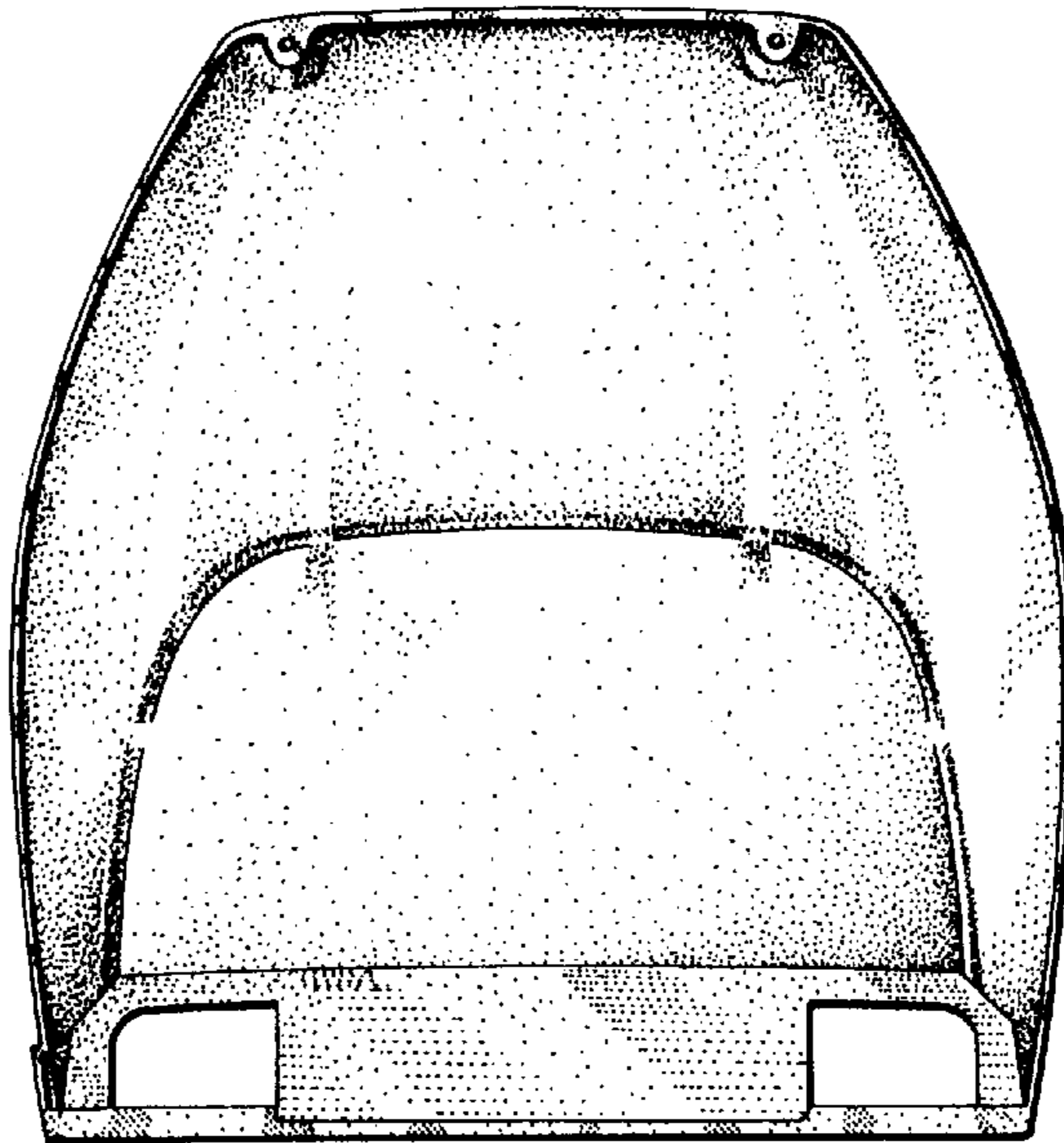

FIG. 9

