



US00D414684S

# United States Patent [19]

Usui et al.

[11] Patent Number: Des. 414,684

[45] Date of Patent: \*\* Oct. 5, 1999

[54] BOTTLE

[75] Inventors: Takeshi Usui; Yasuo Kiuchi, both of Tokyo, Japan

[73] Assignee: Pola Chemical Industries Incorporated, Shizuoka-ken, Japan

[\*\*] Term: 14 Years

[21] Appl. No.: 29/086,690

[22] Filed: Apr. 17, 1998

[51] LOC (6) Cl. .... 09-01

[52] U.S. Cl. .... D9/300

[58] Field of Search ..... D9/300, 435, 445, D9/448, 454, 500, 503, 504, 549; 222/251, 320, 321.1, 321.6, 321.7, 321.8, 321.9

### [56] References Cited

#### U.S. PATENT DOCUMENTS

- D. 184,115 12/1958 Stark .
- D. 189,374 11/1960 Harris .
- D. 332,050 12/1992 Schmidt ..... D9/502
- D. 334,705 4/1993 Pereira et al. .... D9/300
- D. 373,730 9/1996 Baron ..... D9/504
- 3,263,871 8/1966 Thompson .

#### FOREIGN PATENT DOCUMENTS

- 7-24621 8/1995 Japan .
- 7-24622 8/1995 Japan .

Primary Examiner—Cathron B. Matta  
Attorney, Agent, or Firm—Knobbe, Martens, Olson & Bear, LLP

### [57] CLAIM

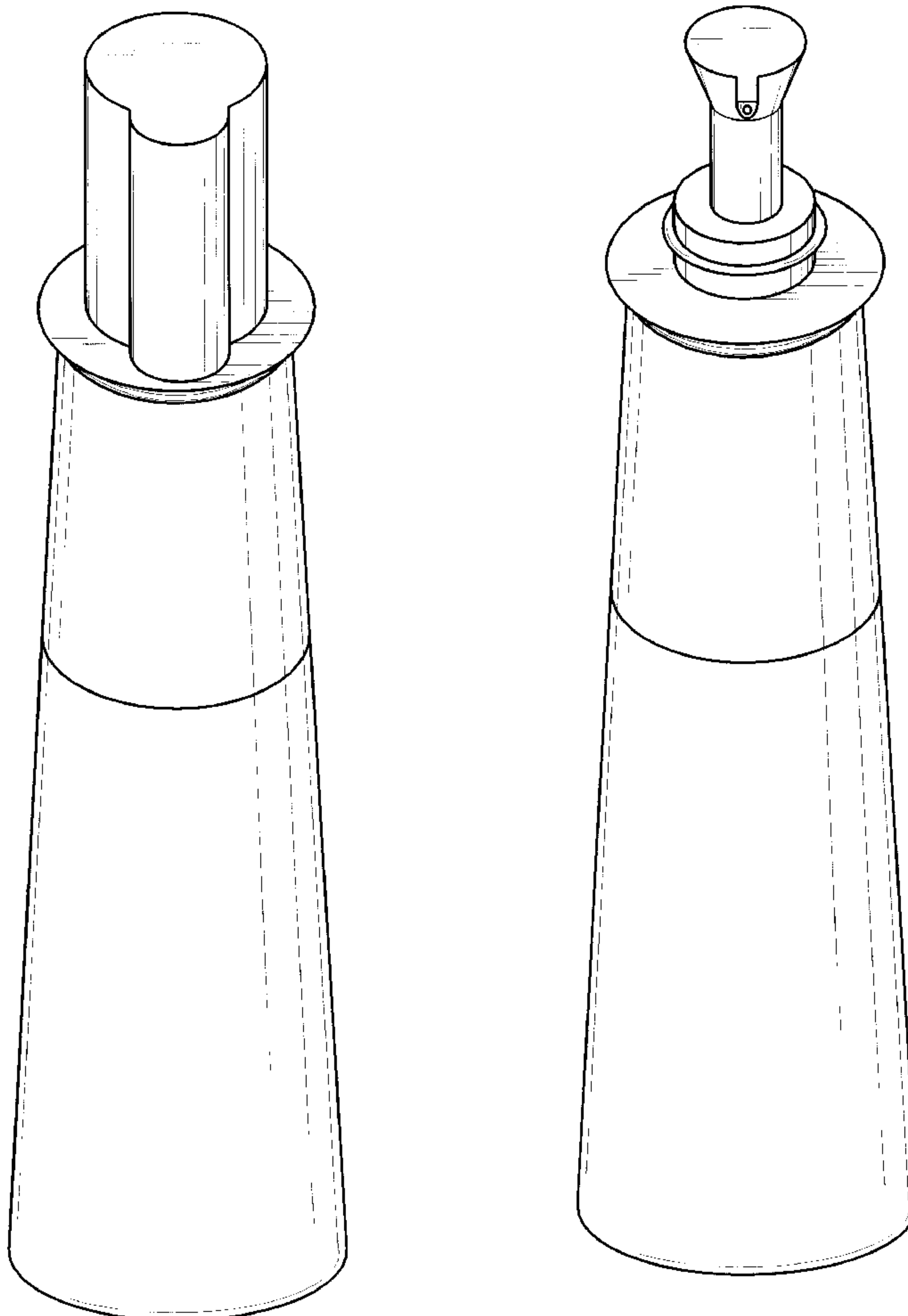
The ornamental design for a bottle, as shown and described.

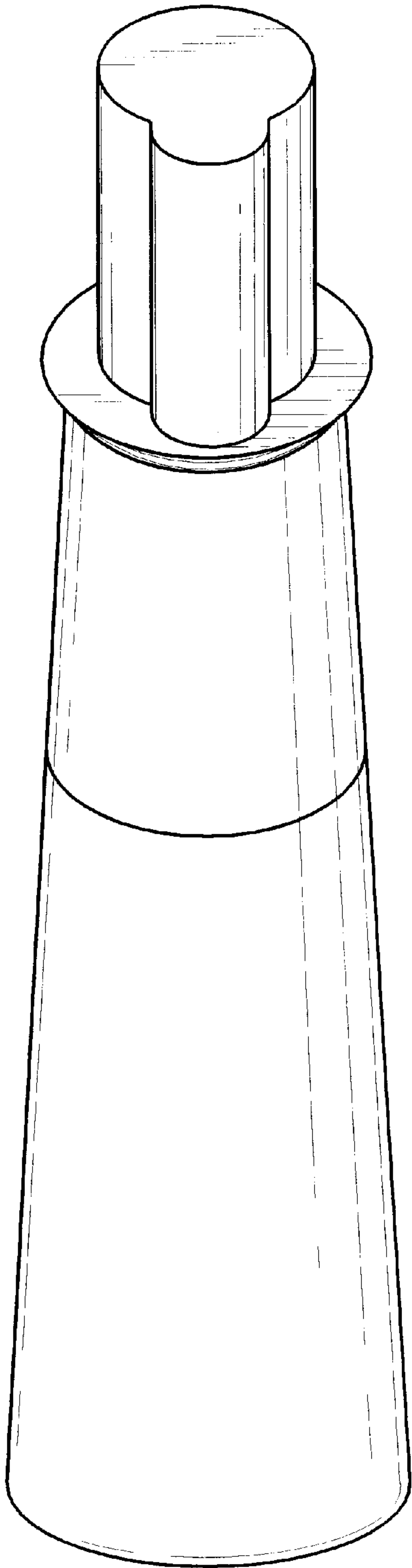
#### DESCRIPTION

FIG. 1 is a front perspective view of a bottle in accordance with a preferred embodiment of the present invention. FIG. 2 is a front perspective view of the bottle of FIG. 1 without the cap. FIG. 3 is a front elevational view of the bottle of FIG. 1. FIG. 4 is a rear elevational view of the bottle of FIG. 1. FIG. 5 is a top plan view of the bottle of FIG. 1. FIG. 6 is a bottom view of the bottle of FIG. 1. FIG. 7 is a right side view of the bottle of FIG. 1; and, FIG. 8 is a left side view of the bottle of FIG. 1.

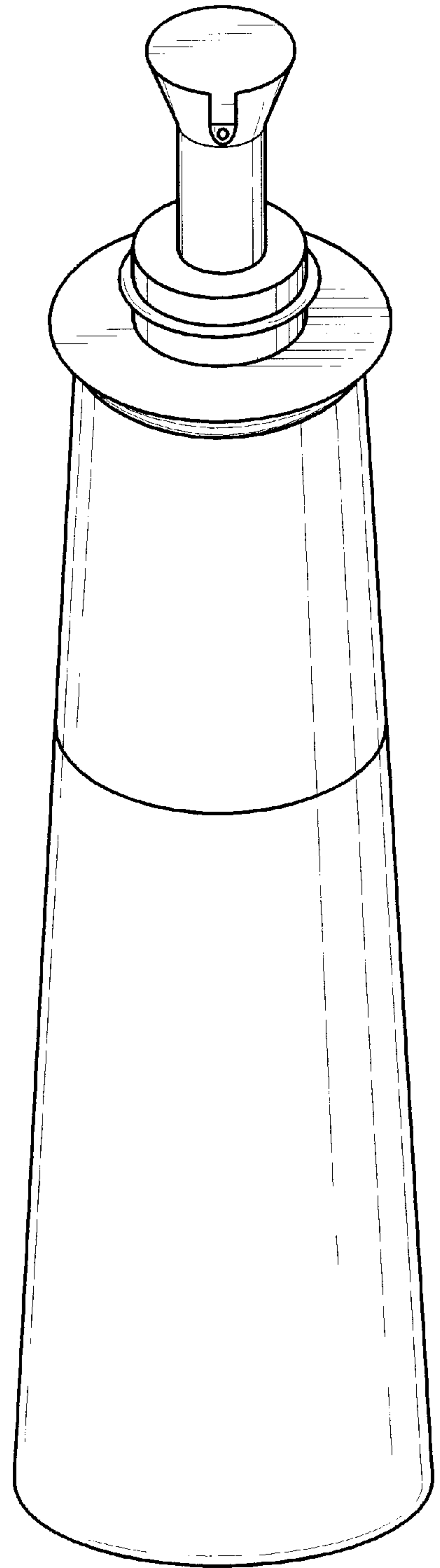
The surface(s) or portion(s) of the article not shown in the drawing or described in the specification form(s) no part of the claimed design.

1 Claim, 3 Drawing Sheets

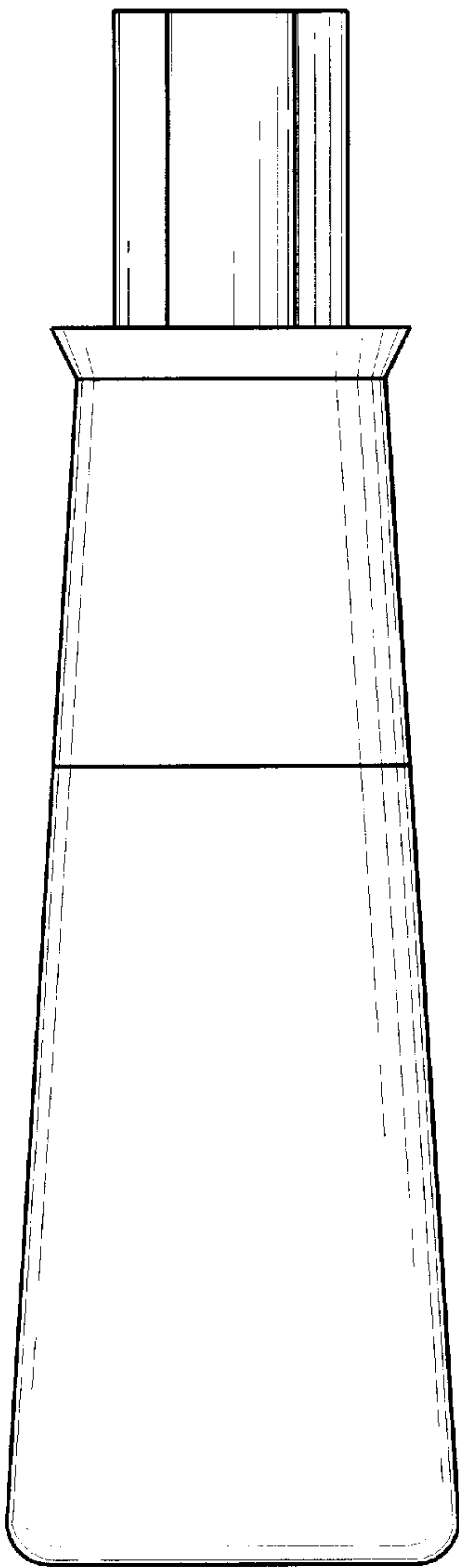




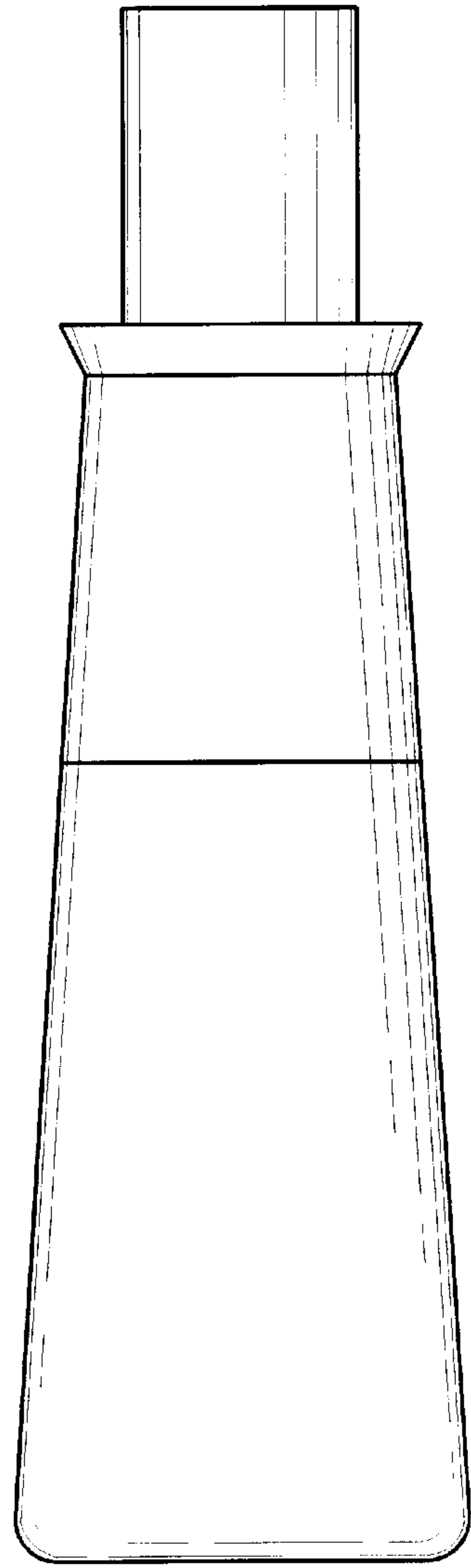
*FIG. 1*



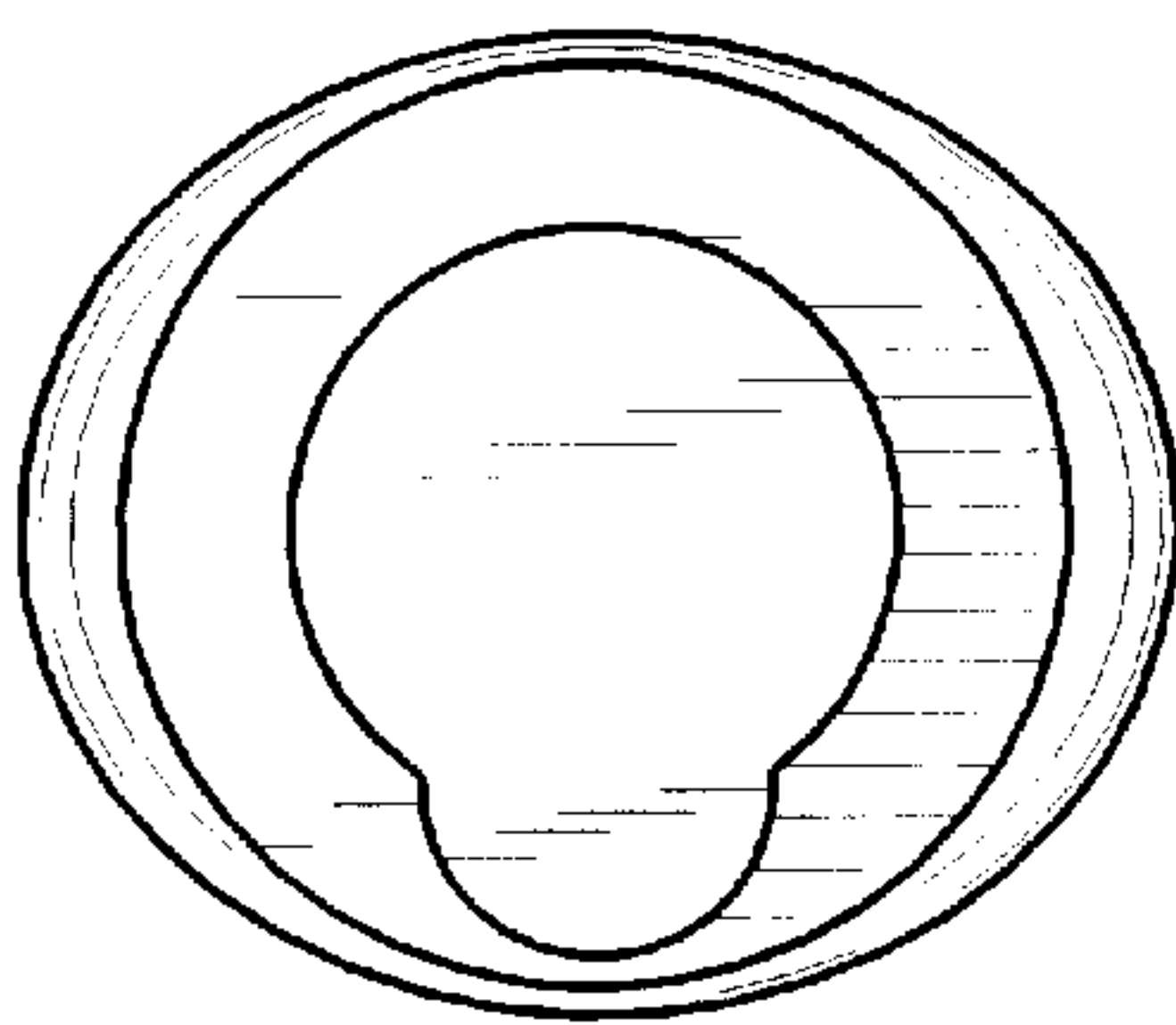
*FIG. 2*



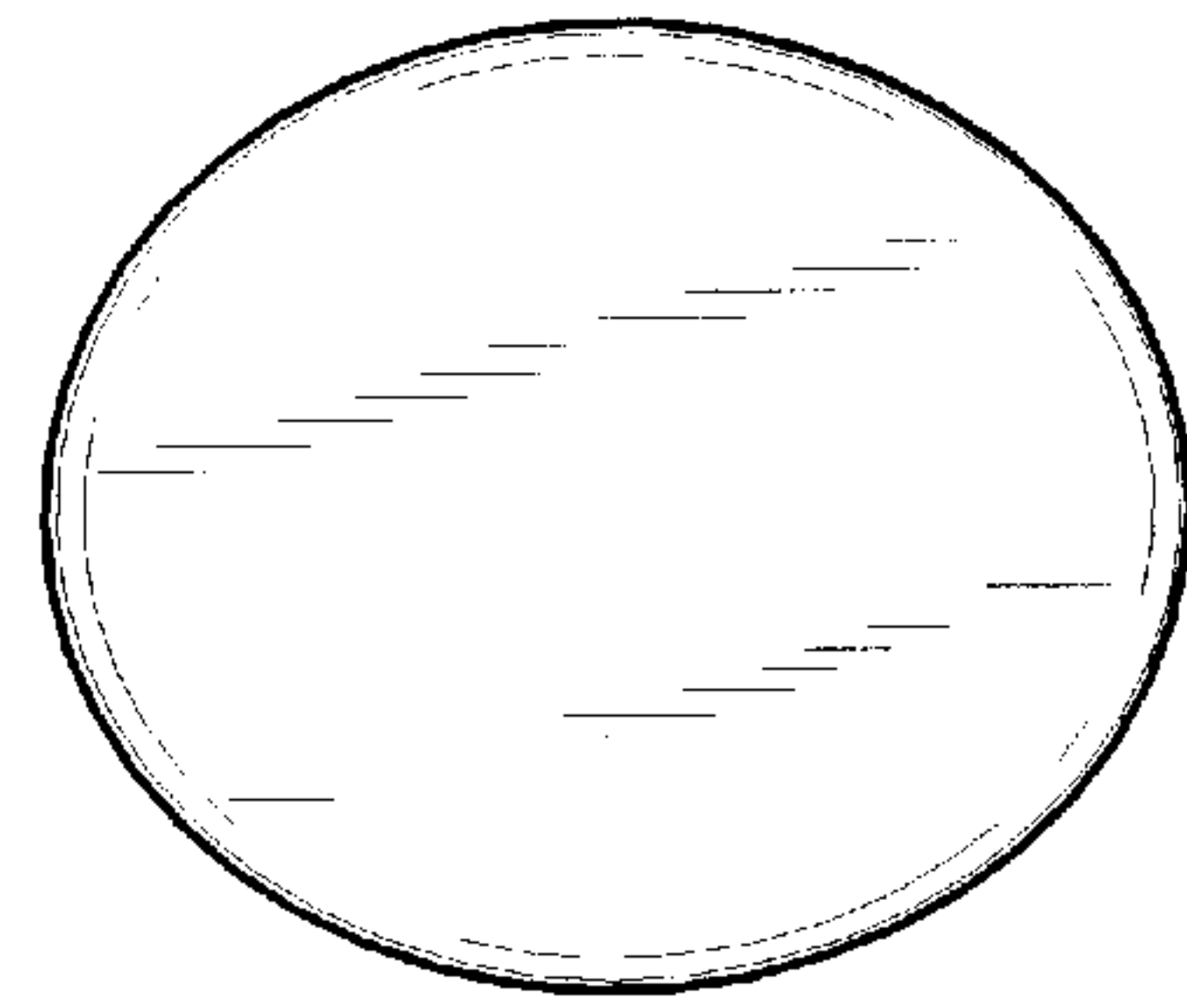
*FIG. 3*



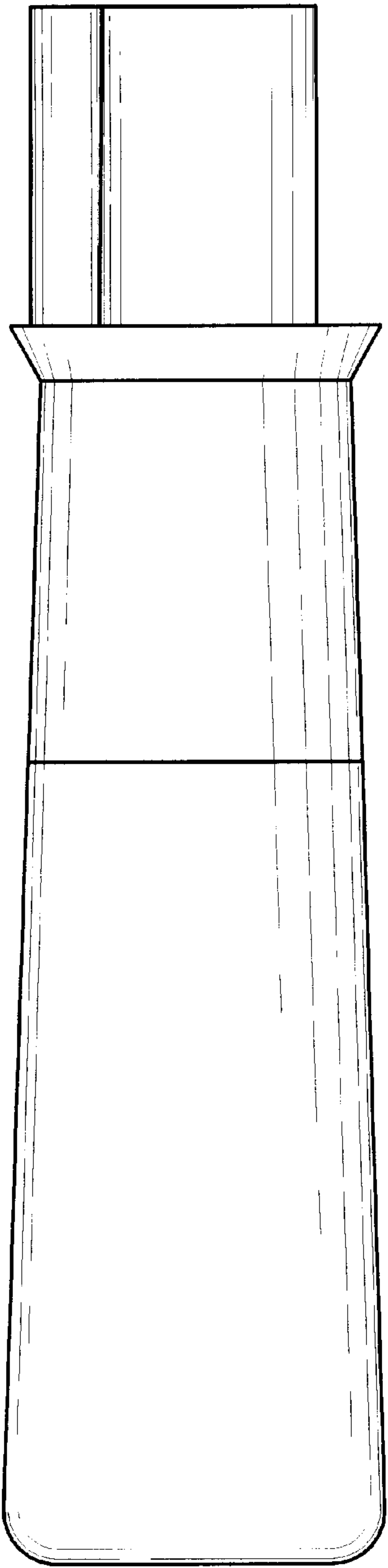
*FIG. 4*



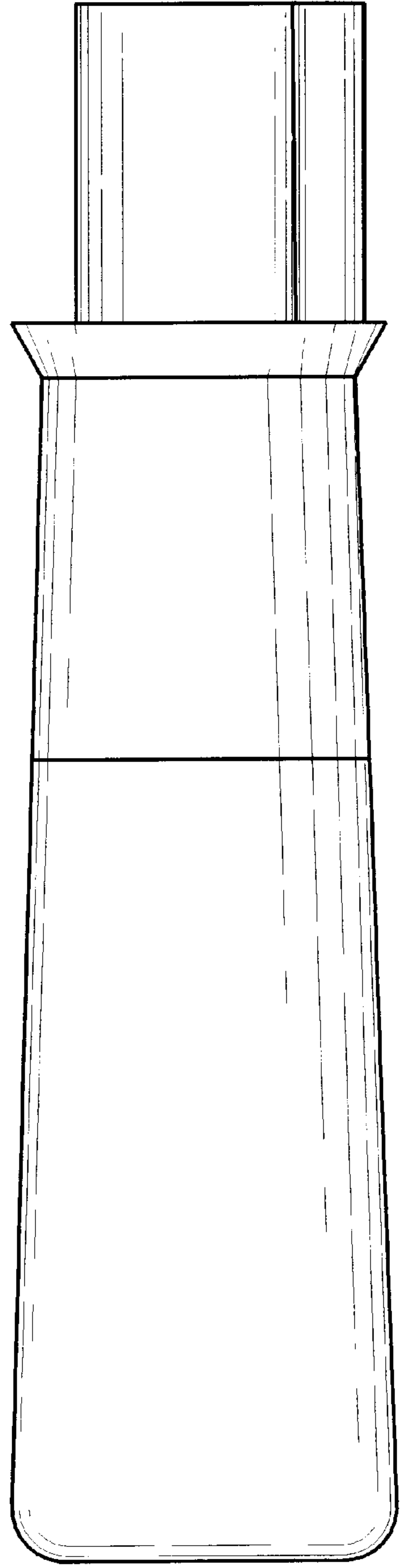
*FIG. 5*



*FIG. 6*



*FIG. 7*



*FIG. 8*