



US00D414647S

United States Patent [19]
Driscoll et al.

[11] **Patent Number: Des. 414,647**
[45] **Date of Patent: ** Oct. 5, 1999**

[54] **BREWING APPLIANCE**

[75] Inventors: **Mark Driscoll**, Cleveland; **Marc L. Vitantonio**, S. Russell; **John Sovis**, Twinsburg, all of Ohio

[73] Assignee: **Signature Brands, Inc.**, Glenwillow, Ohio

[**] Term: **14 Years**

[21] Appl. No.: **29/086,055**

[22] Filed: **Apr. 3, 1998**

[51] **LOC (6) Cl.** **07-01**

[52] **U.S. Cl.** **D7/309; D7/310**

[58] **Field of Search** **D7/309, 310, 311, D7/305; 99/280, 292, 290**

[56] **References Cited**

U.S. PATENT DOCUMENTS

D. 310,931	10/1990	Mollenhoff	D7/309
D. 344,427	2/1994	Bannigan	D7/309
D. 367,201	2/1996	Joergensen	D7/305
D. 377,577	1/1997	Cousins et al.	D7/309
D. 399,698	10/1998	Saltet	D7/309

D. 404,604	1/1999	Pochopien et al.	D7/309
4,386,556	6/1983	Romey, Sr.	99/290
4,572,060	2/1986	Yung-kuan	99/280
4,721,034	1/1988	Shimomura	99/280

Primary Examiner—M. N. Pandozzi
Attorney, Agent, or Firm—Kramer, Levin, Naftalis Frankel LLP

[57] **CLAIM**

The ornamental design for a brewing appliance, as shown and described.

DESCRIPTION

FIG. 1 is a side elevation view of the brewing appliance of the present invention;
FIG. 2 is a side elevation view of the brewing appliance of the present invention;
FIG. 3 is a side elevation view of the brewing appliance of the present invention;
FIG. 4 is a top view of the brewing appliance of the present invention; and,
FIG. 5 is a bottom view of the brewing appliance of the present invention.

1 Claim, 5 Drawing Sheets

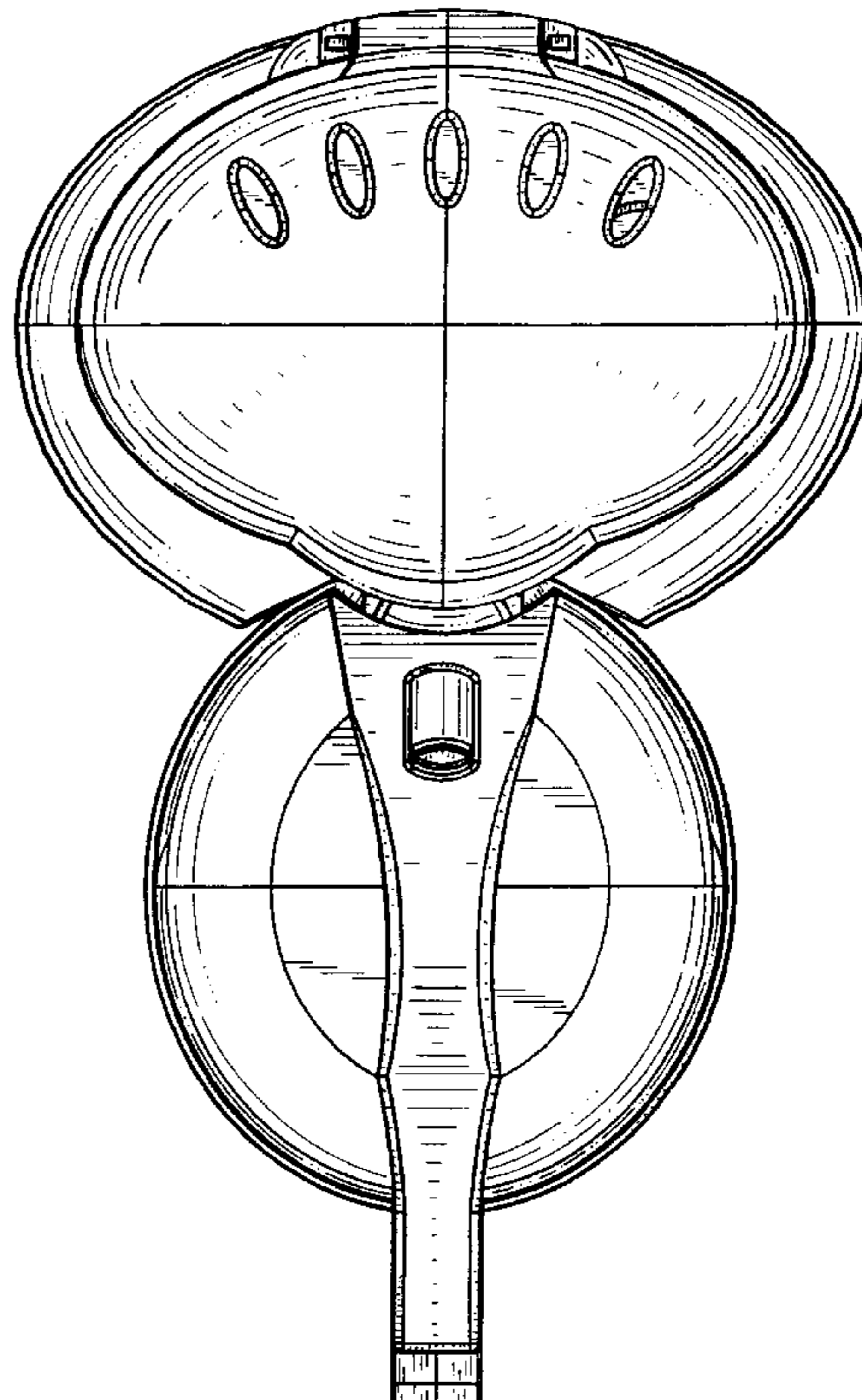
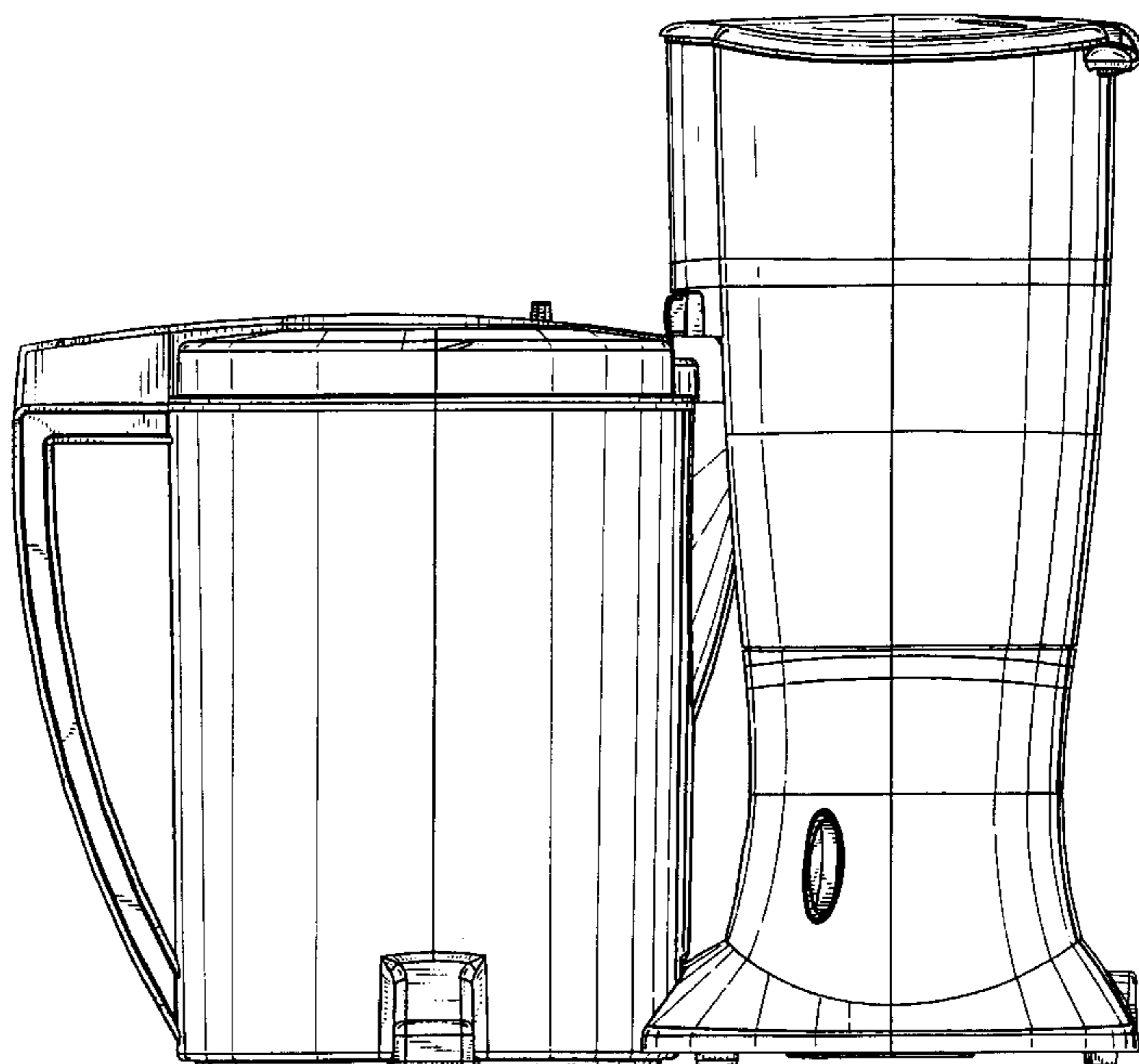
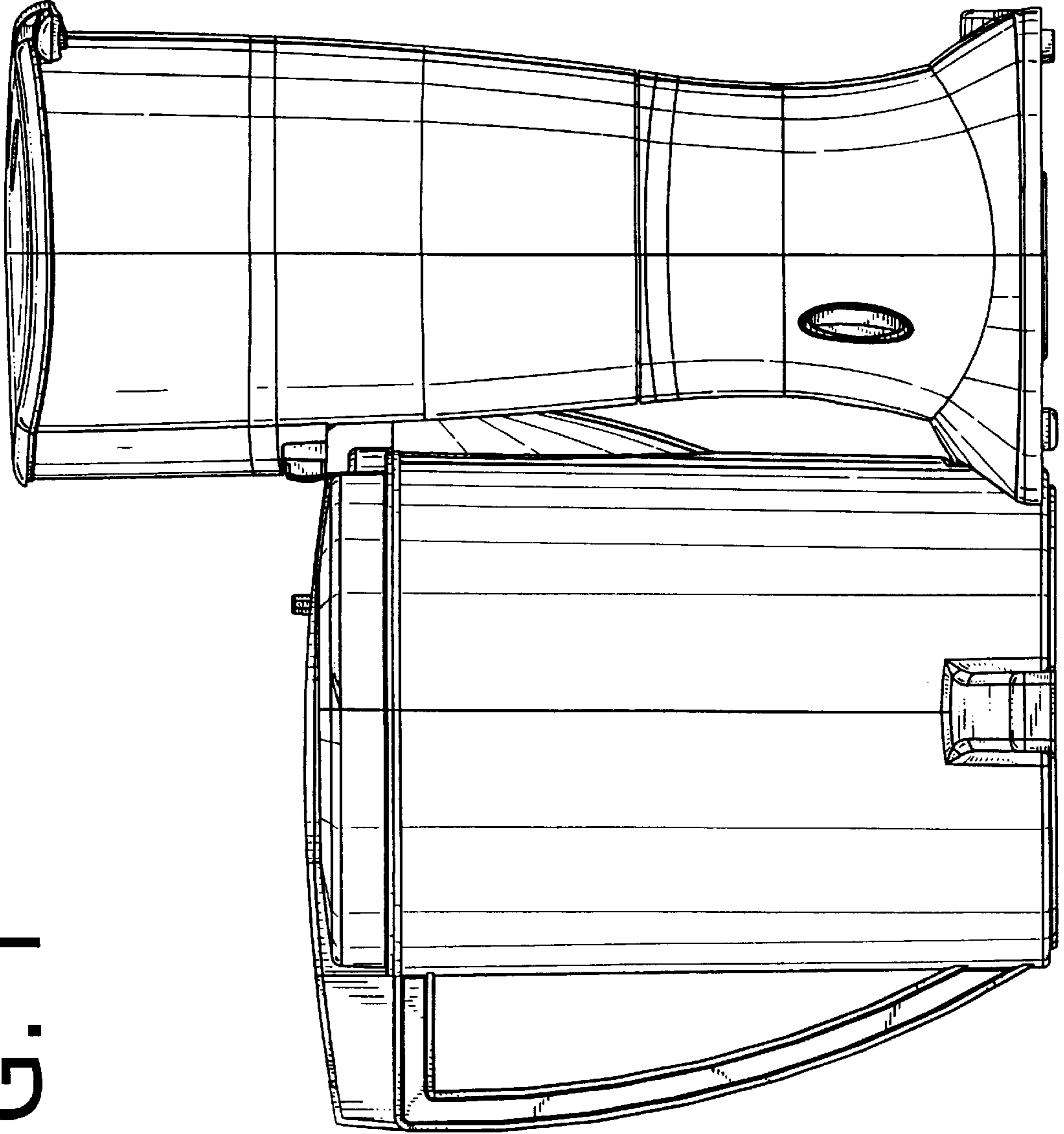

FIG. 1



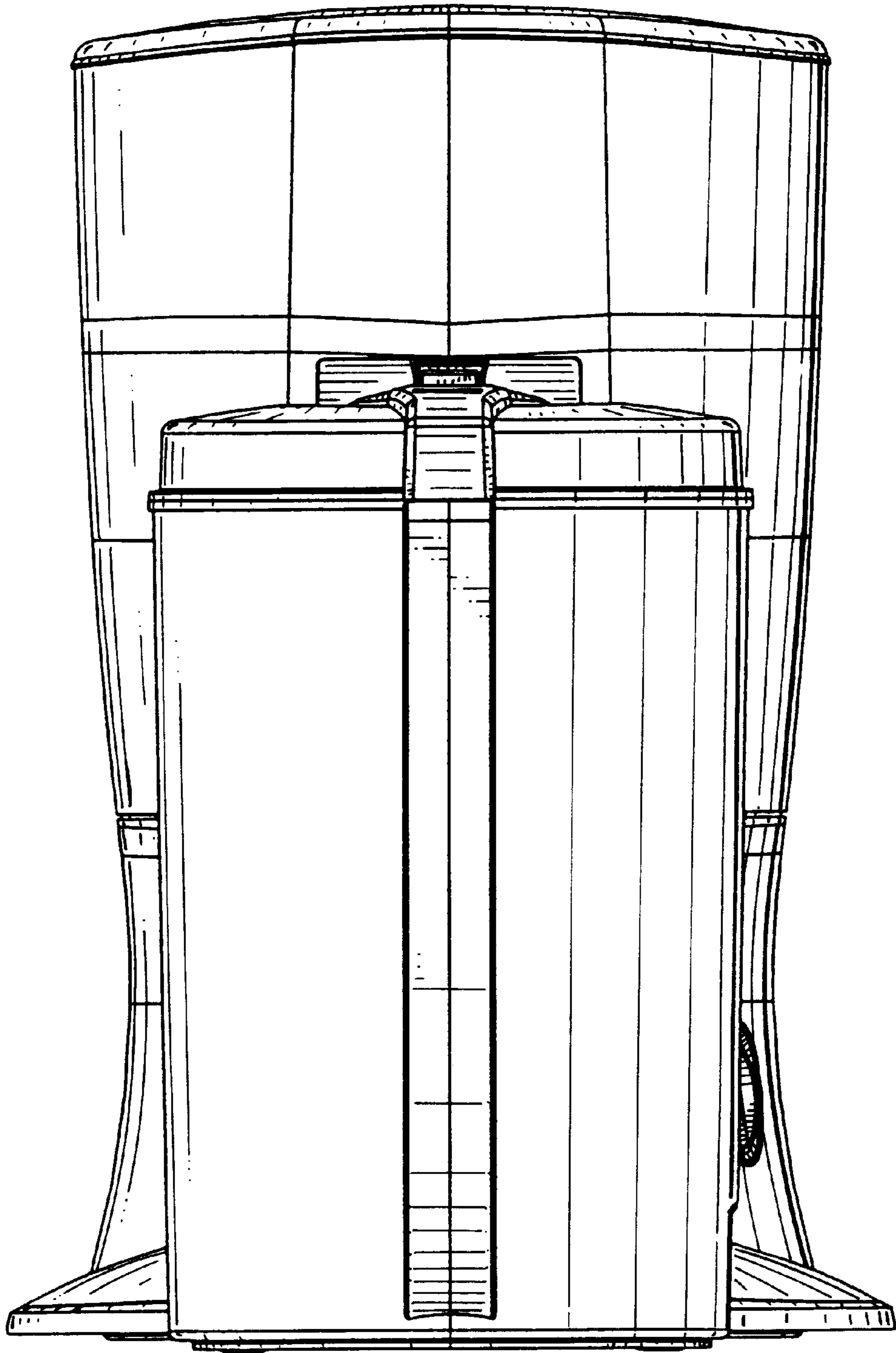

FIG. 2

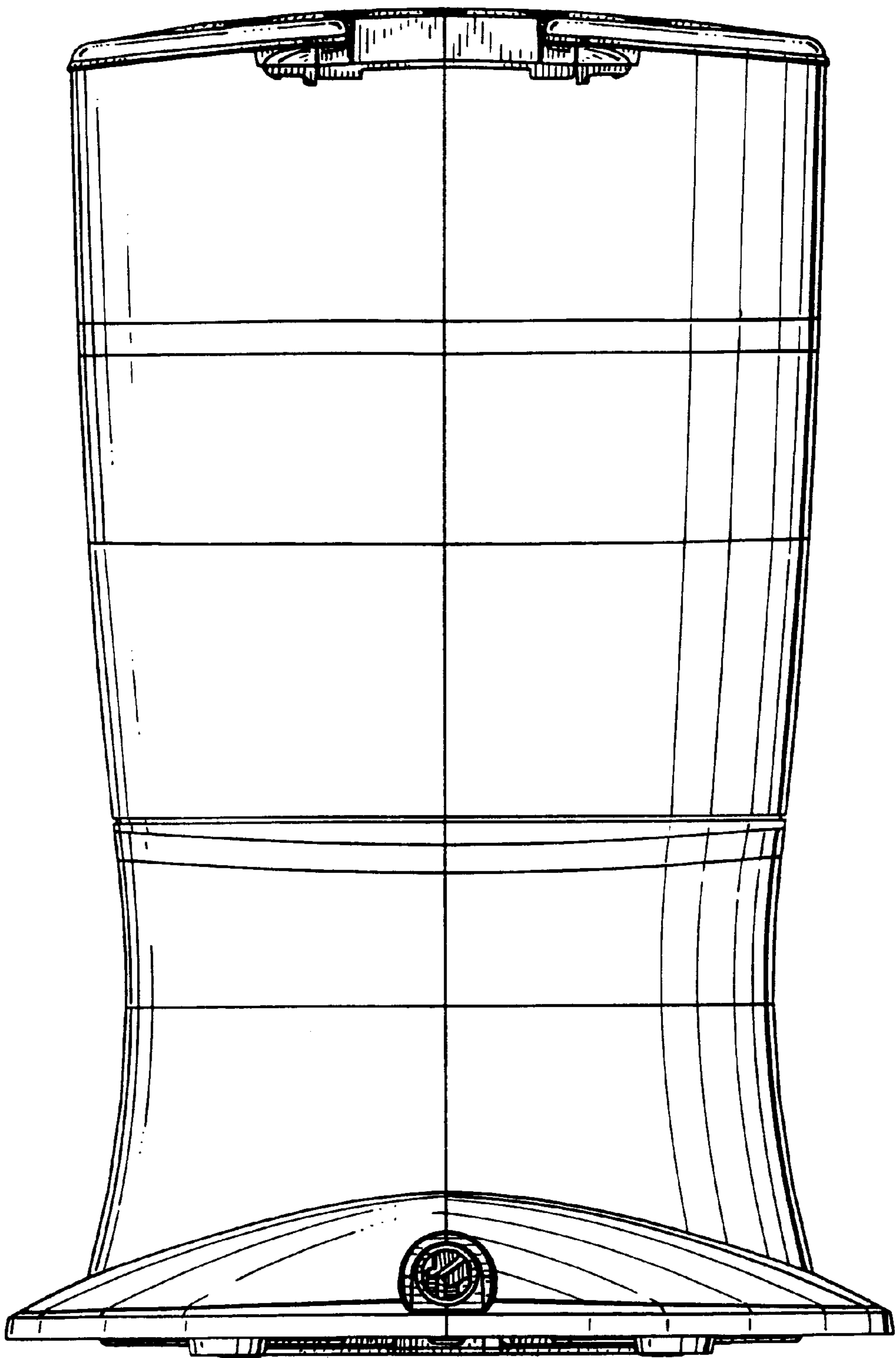

FIG. 3

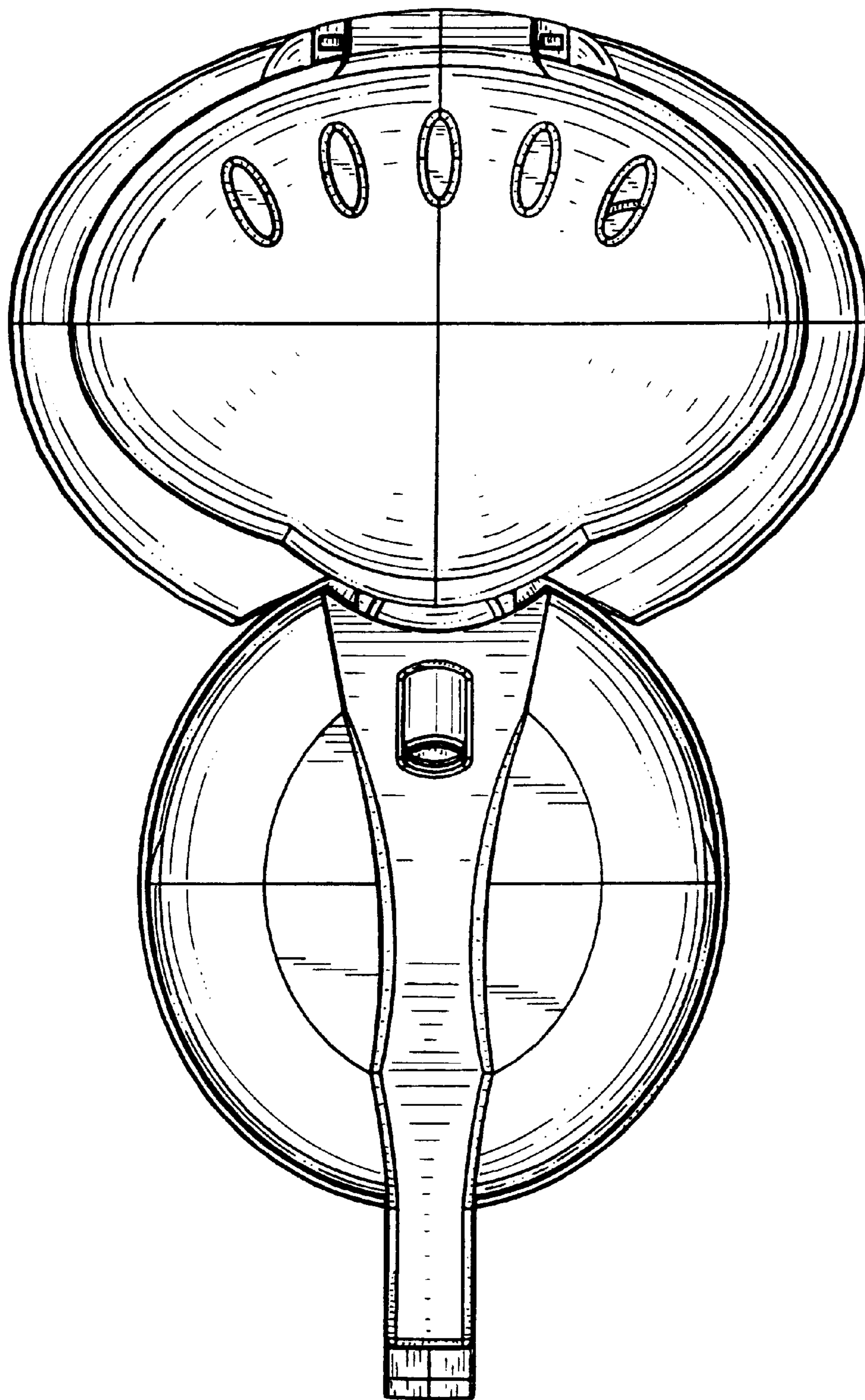

FIG. 4

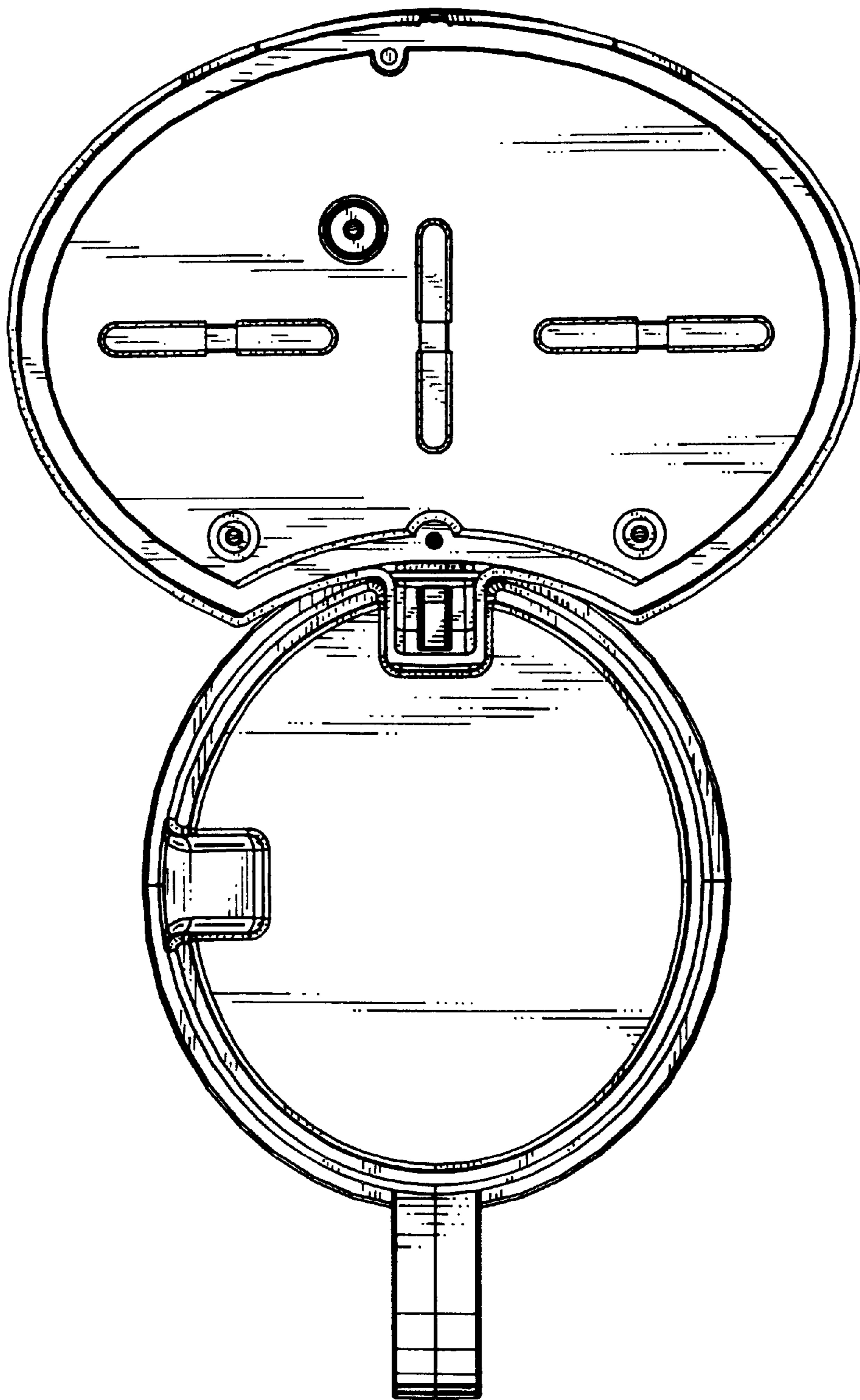

FIG. 5