



US00D414622S

# United States Patent [19]

Vaaler

[11] Patent Number: Des. 414,622

[45] Date of Patent: \*\* Oct. 5, 1999

[54] BED

[75] Inventor: Lawrence I. Vaaler, Lenoir, N.C.

[73] Assignee: Bernhardt, L.L.C., Lenoir, N.C.

[\*\*] Term: 14 Years

[21] Appl. No.: 29/103,313

[22] Filed: Apr. 13, 1999

[51] LOC (6) Cl. .... 06-01

[52] U.S. Cl. .... D6/393

[58] Field of Search ..... D6/382, 388-395,  
D6/505-508; 5/53.1, 279.1, 280, 281, 907

## [56] References Cited

### U.S. PATENT DOCUMENTS

|            |        |               |       |        |
|------------|--------|---------------|-------|--------|
| D. 344,643 | 3/1994 | Rosen         | ..... | D6/393 |
| D. 392,811 | 3/1998 | Bergelin      | ..... | D6/393 |
| D. 405,974 | 2/1999 | Estape et al. | ..... | D6/393 |

Primary Examiner—Janice E. Seeger  
Attorney, Agent, or Firm—Rhodes & Mason, PLLC

## [57] CLAIM

The ornamental design for a bed, as shown and described.

## DESCRIPTION

FIG. 1 is a left front perspective view of a bed showing my new design;

FIG. 2 is a side view thereof, the opposite side view being a mirror image;

FIG. 3 is a partial elevational view of the headboard showing my new design;

FIG. 4 is a front elevational view of the footboard showing my new design;

FIG. 5 is a partial rear perspective view of the footboard; and,

FIG. 6 is an enlarged partial view of the headboard corner. The broken lines are for environmental purposes only and form no part of the claimed design.

1 Claim, 5 Drawing Sheets

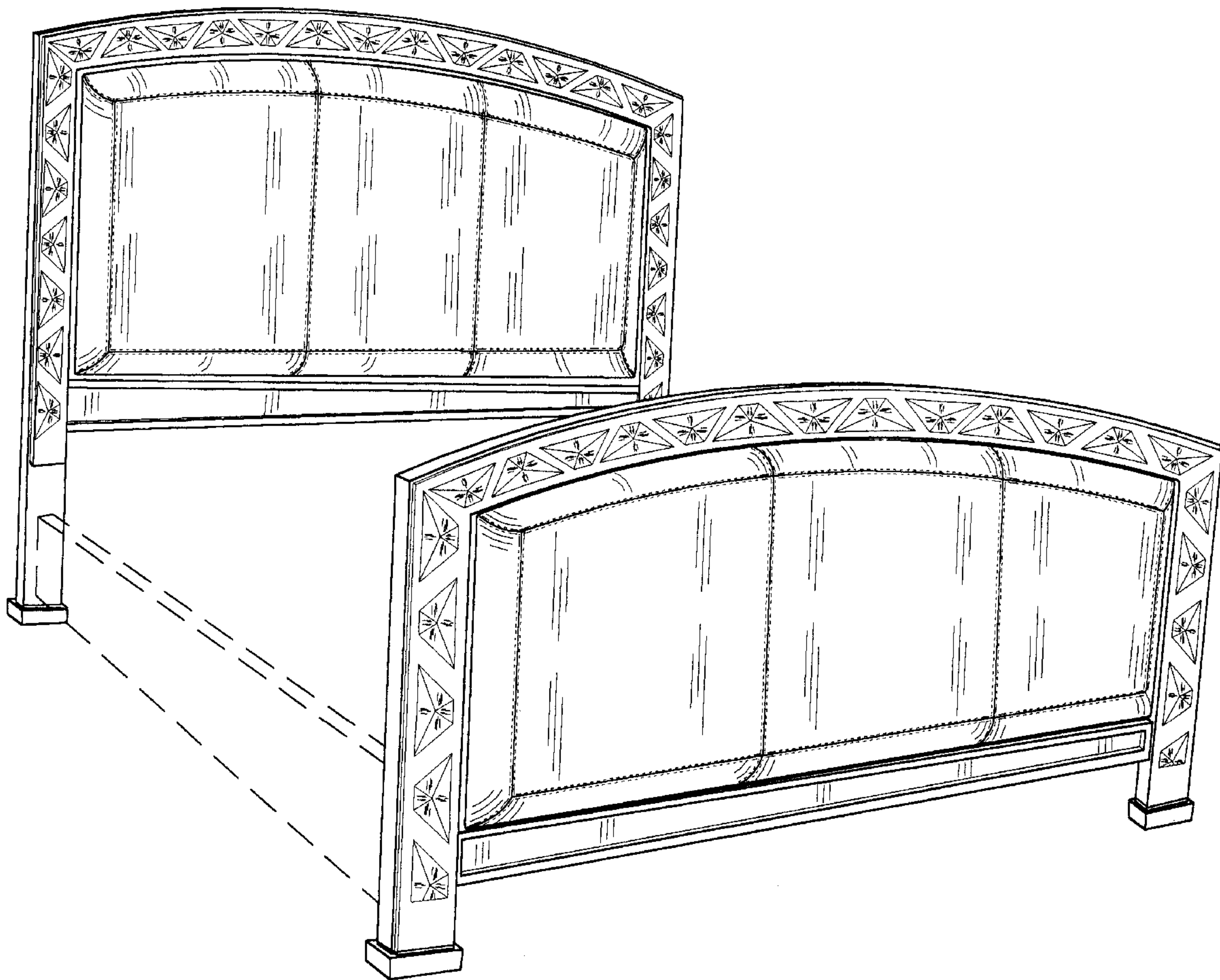

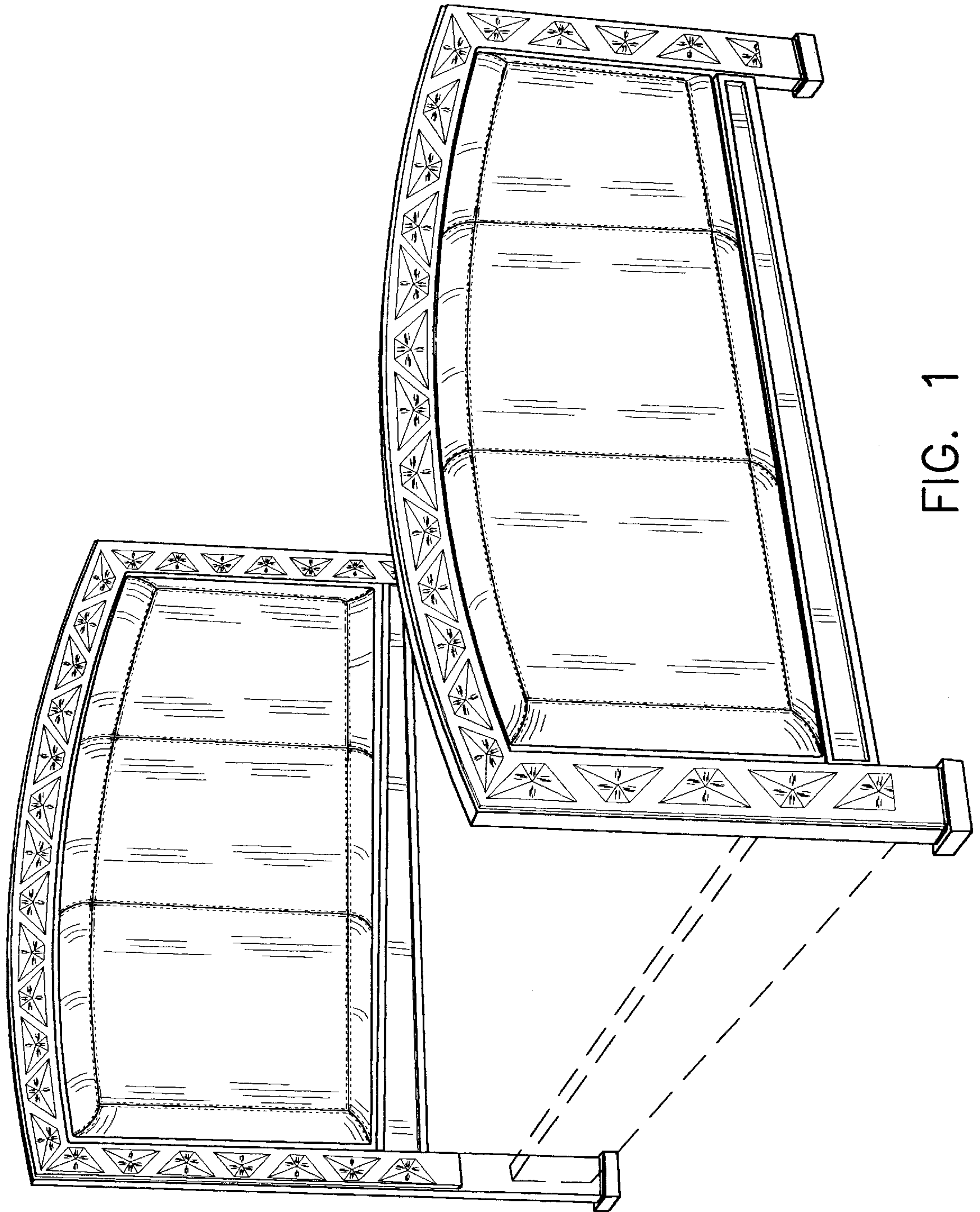

FIG. 1

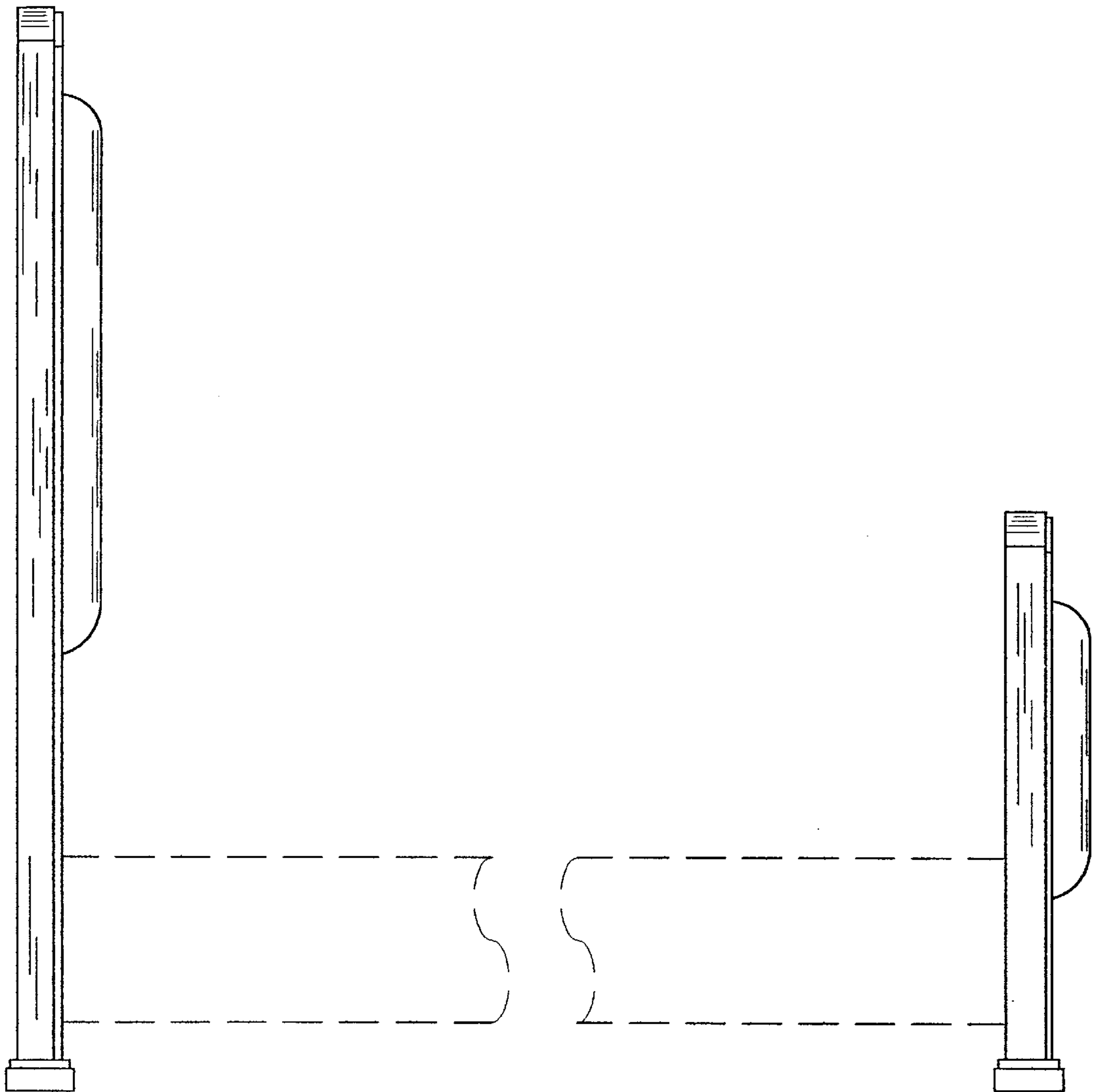

FIG. 2

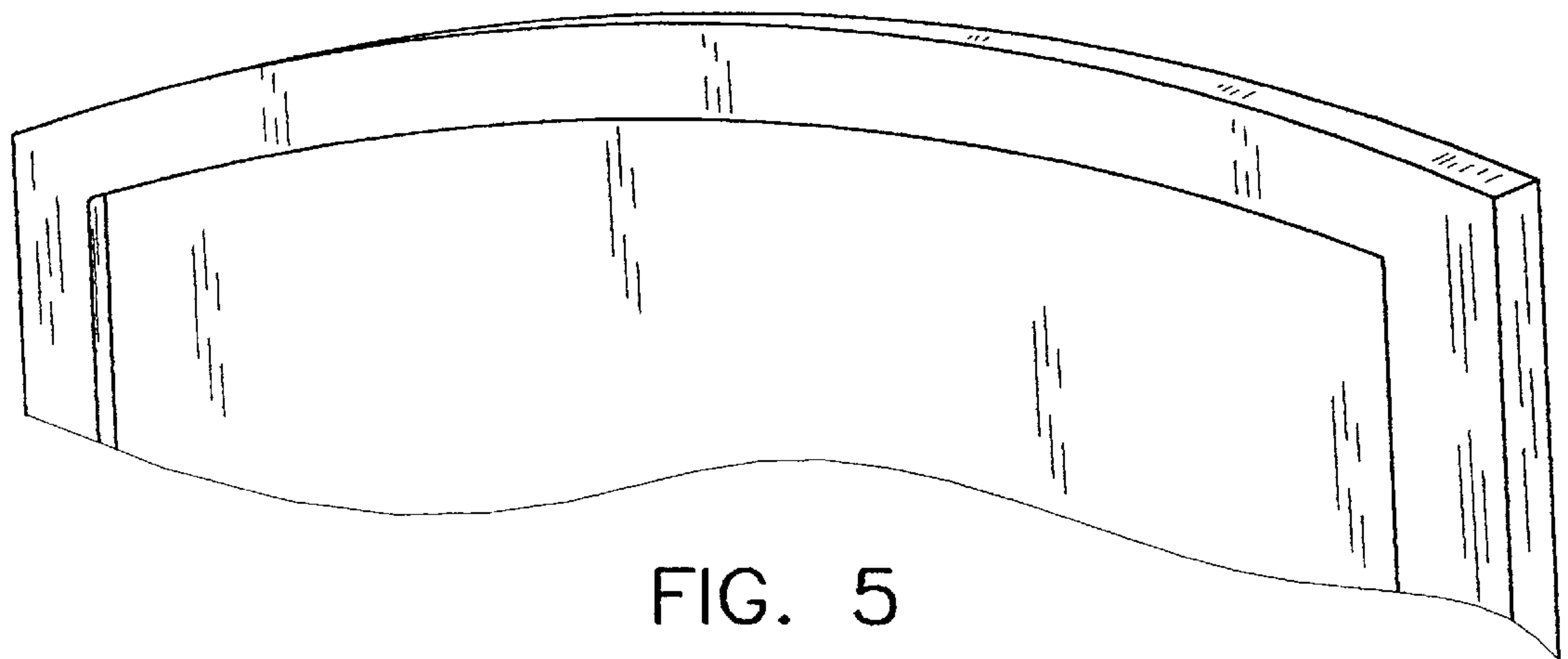

FIG. 5

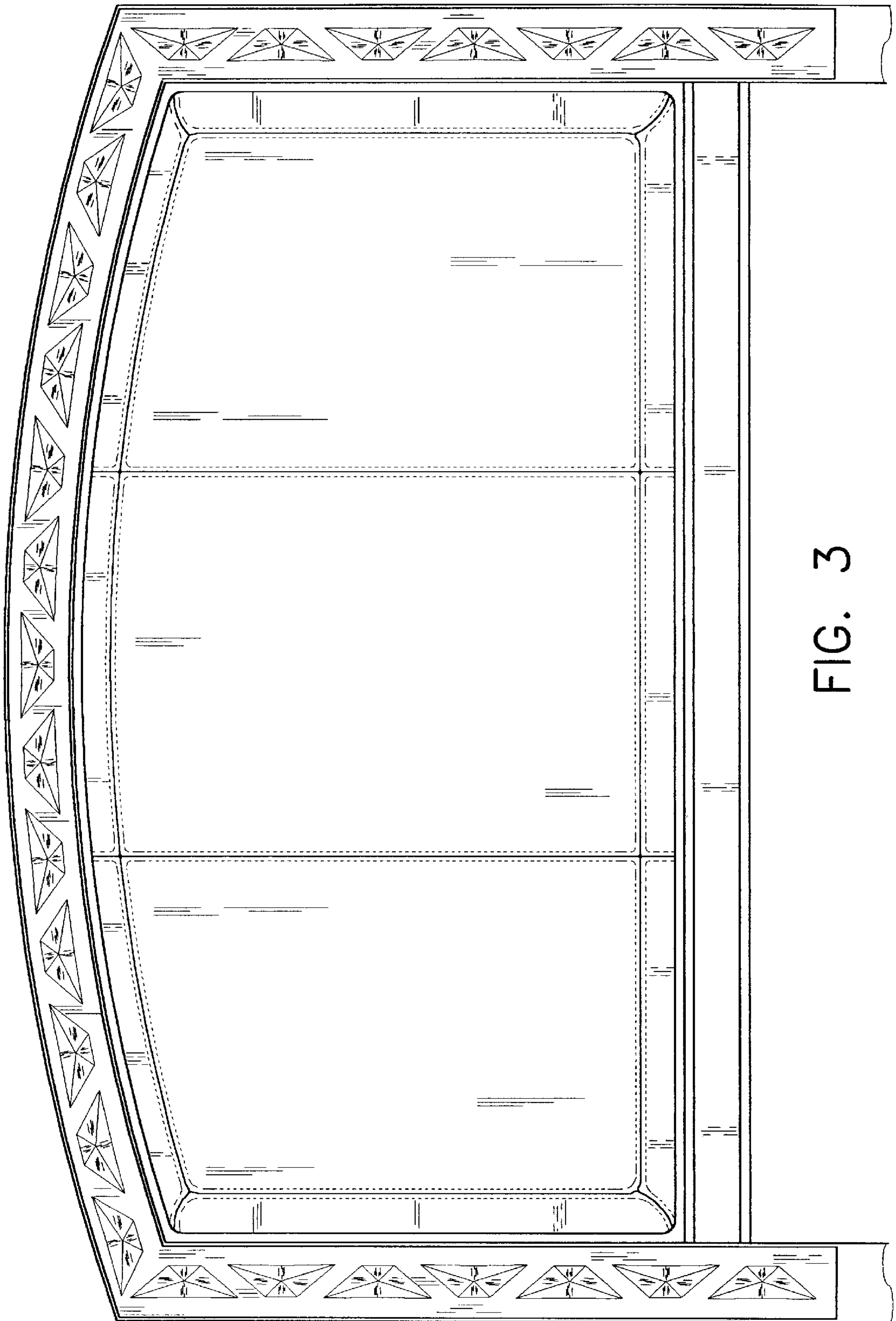

FIG. 3



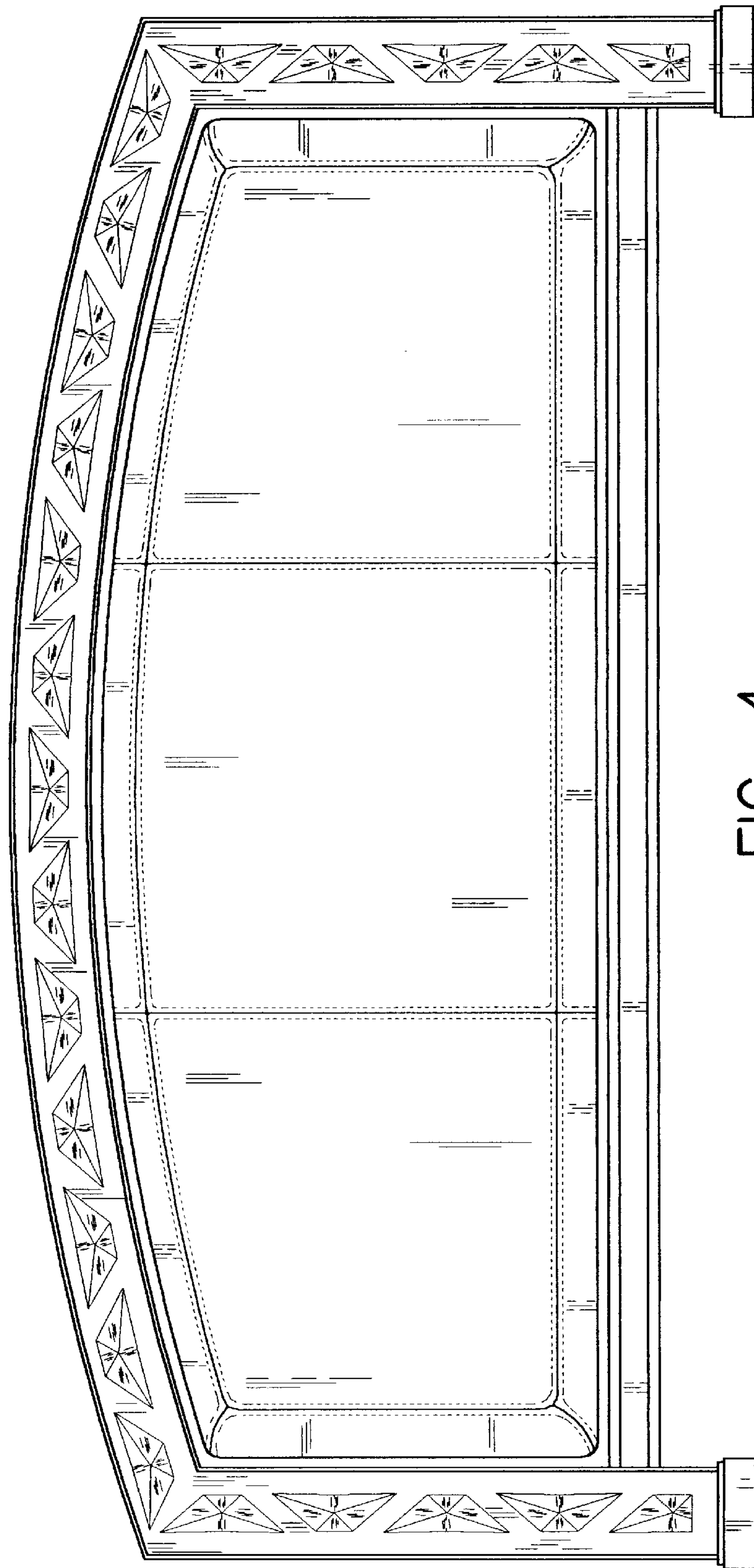

FIG. 4

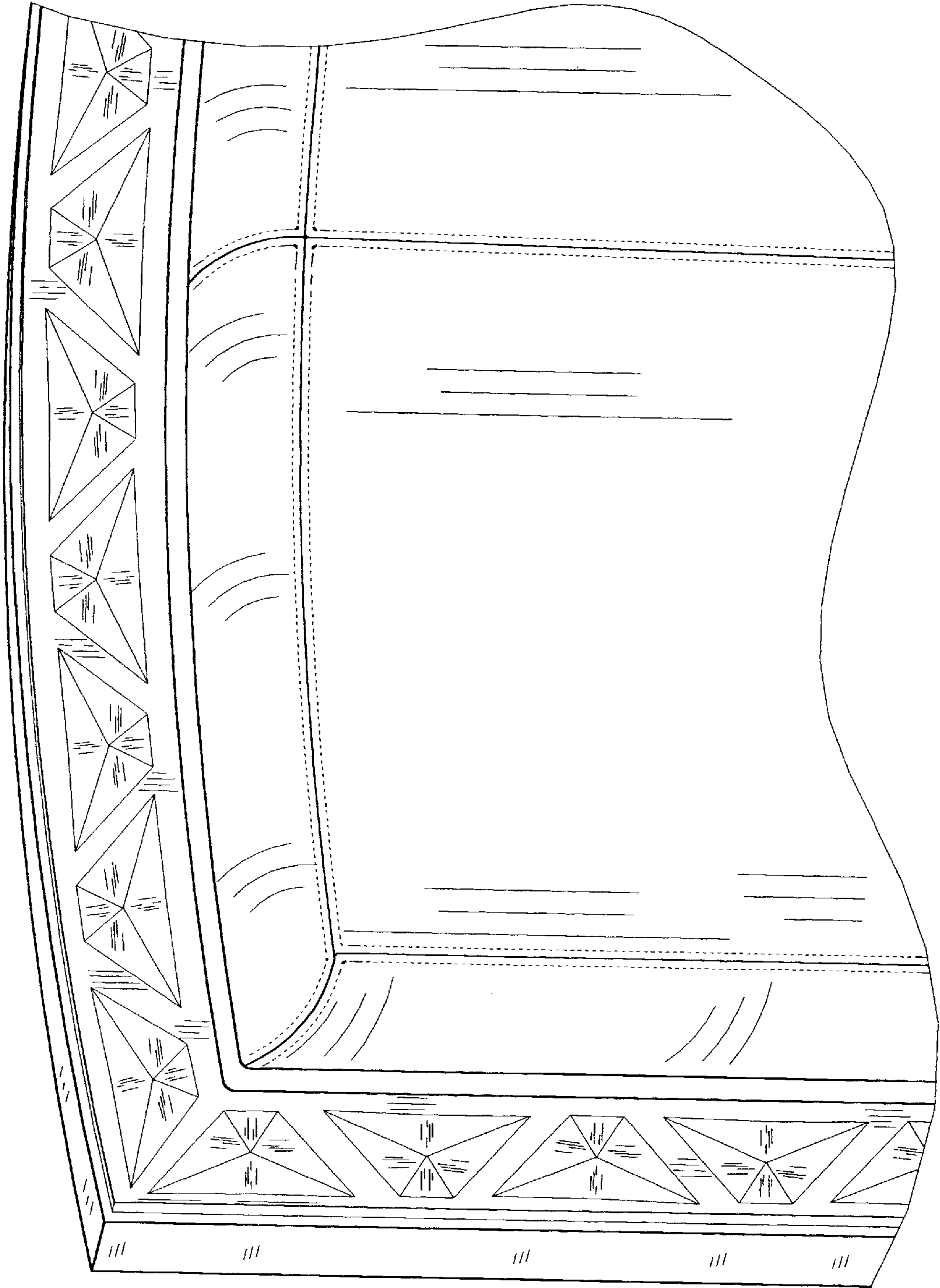

FIG. 6