



US00D414594S

# United States Patent [19] Parisotto

[11] Patent Number: **Des. 414,594**

[45] Date of Patent: **\*\* Oct. 5, 1999**

[54] **SPORTS FOOTWEAR SOLE**

[75] Inventor: **Davide Parisotto**, Casella d'Asolo, Italy

[73] Assignee: **Calzaturificio S.C.A.R.P.A S.p.A.**, Viale Tiziano, Italy

[\*\*] Term: **14 Years**

[21] Appl. No.: **29/091,923**

[22] Filed: **Aug. 7, 1998**

[51] **LOC (6) Cl.** ..... **02-04**

[52] **U.S. Cl.** ..... **D2/959; D2/951; D2/959; D2/960**

[58] **Field of Search** ..... D2/896, 897, 902, D2/906, 908, 909, 914, 916, 919, 946-962, 964, 977; 36/3 B, 11.5, 12-15, 25 R, 28, 32 R, 44, 59 C, 66, 75 R, 76 R, 85, 101, 103, 104, 106, 113-115, 124, 126, 127-130

[56] **References Cited**

**U.S. PATENT DOCUMENTS**

D. 185,462	6/1959	Ratner	.....	D2/957
D. 241,586	9/1976	Sebeatik	.....	D2/955
D. 257,647	12/1980	Combaret	.....	D2/953

D. 286,342	10/1986	Stubblefield	.....	D2/957
D. 290,543	6/1987	Yonkers	.....	D2/953
D. 294,769	3/1988	Liggett et al.	.....	D2/955
D. 296,724	7/1988	Petersen	.....	D2/957
D. 296,952	8/1988	Brown et al.	.....	D2/946
D. 334,833	4/1993	Blissett	.....	D2/957
D. 385,689	11/1997	James	.....	D2/902
D. 398,440	9/1998	Rowlnd	.....	D2/951
D. 400,696	11/1998	Covatch	.....	D2/954
5,713,140	2/1998	Baggenstoss	.....	36/25 R

*Primary Examiner*—Celia Murphy  
*Attorney, Agent, or Firm*—Ladas & Parry

[57] **CLAIM**

I claim the ornamental design for a sports footwear sole, as shown and described.

**DESCRIPTION**

FIG. 1 is a bottom right perspective view of a sports footwear sole showing my new design; FIG. 2 is a bottom left perspective view thereof; FIG. 3 is a front elevational view thereof; FIG. 4 is a rear elevational view thereof; FIG. 5 is a bottom plan view thereof; and, FIG. 6 is a side elevational view thereof.

**1 Claim, 4 Drawing Sheets**

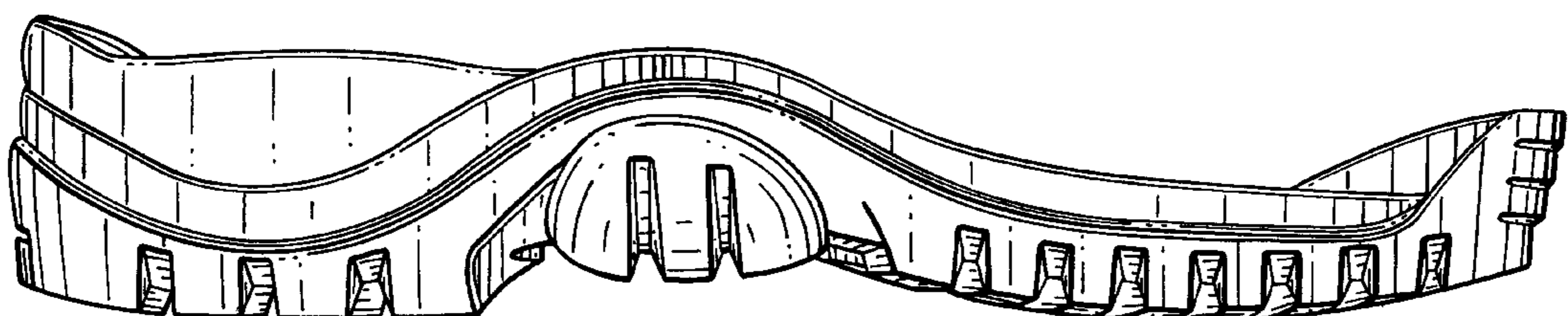
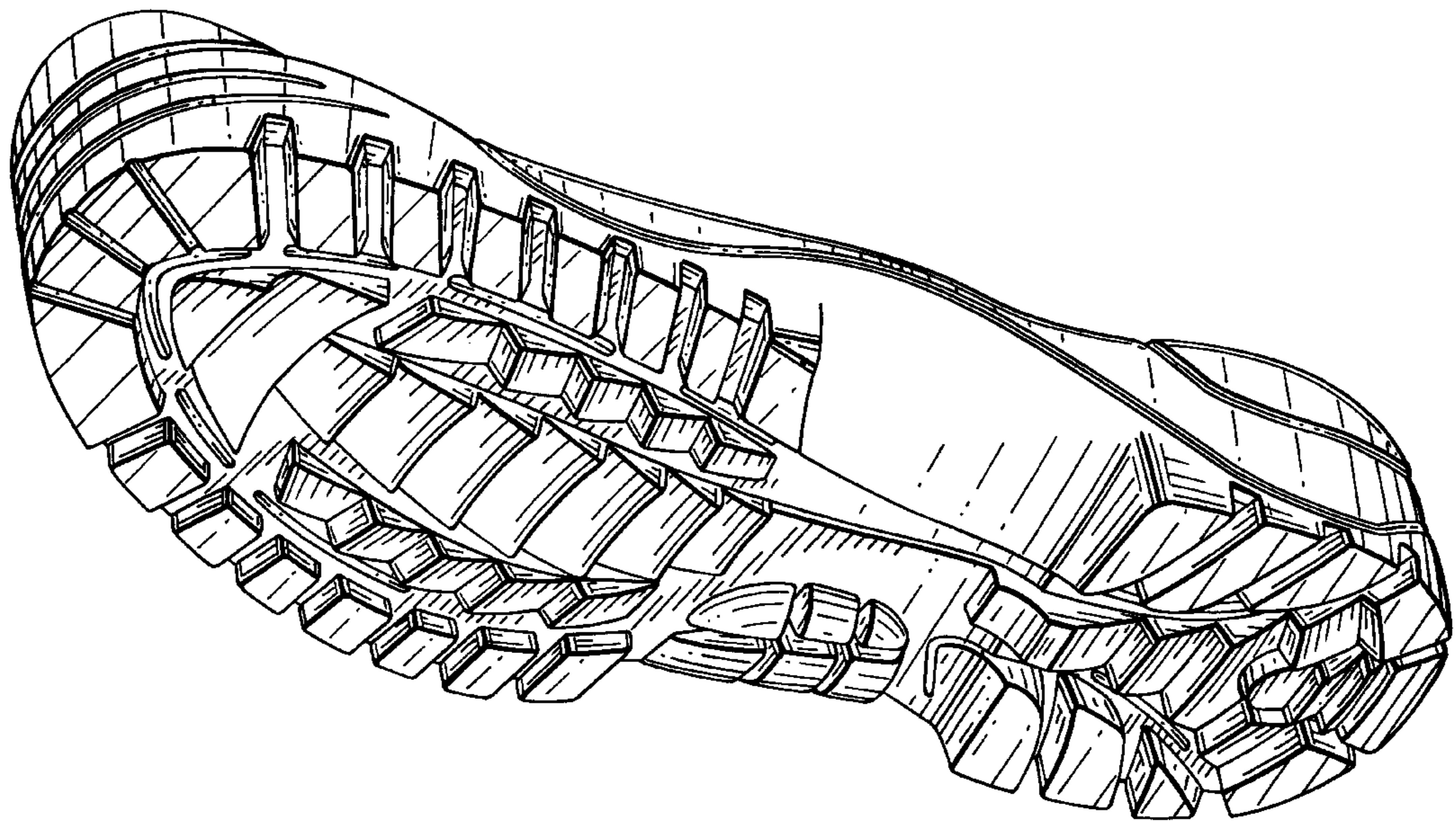
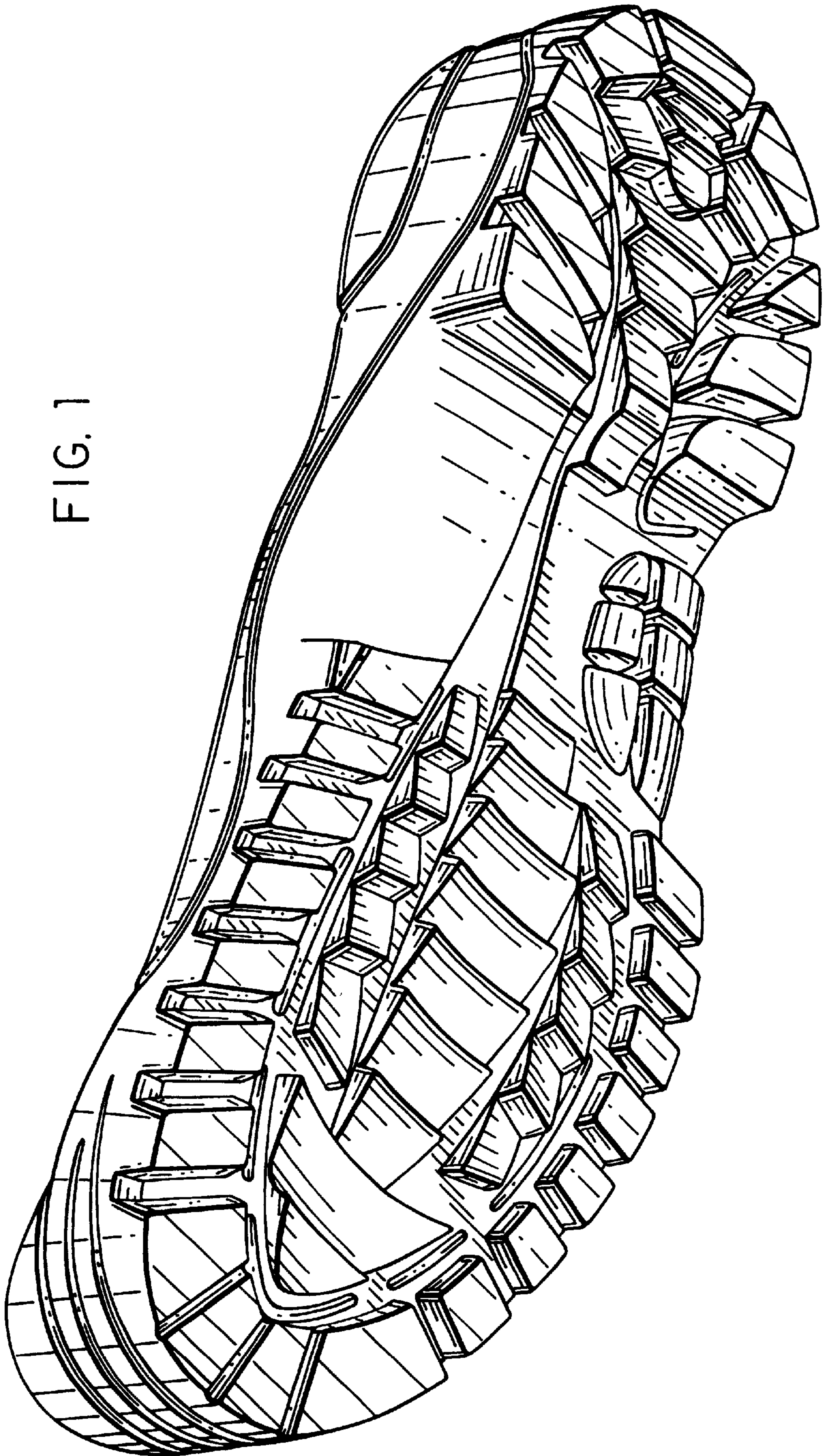

FIG. 1



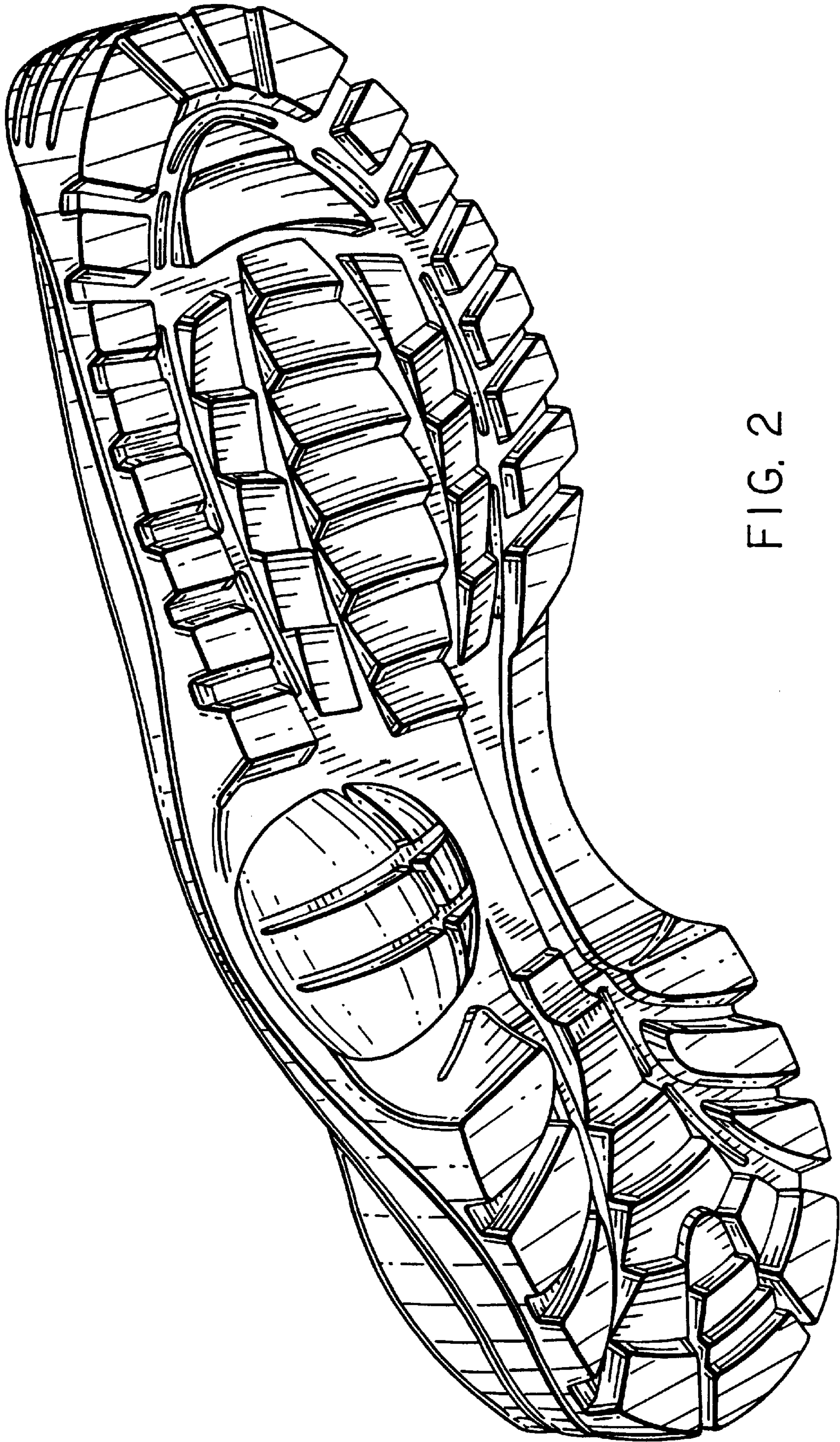

FIG. 2

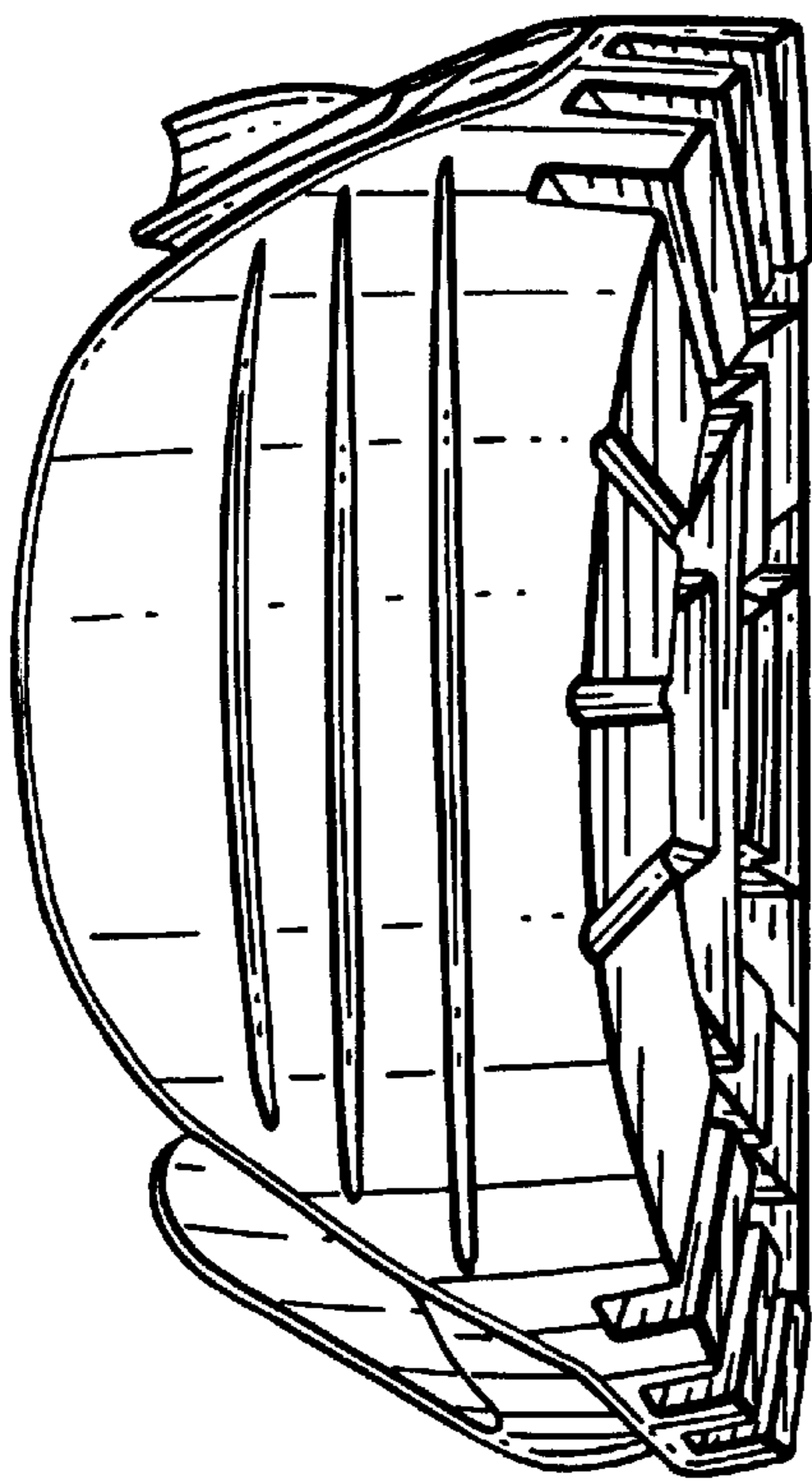

FIG. 3

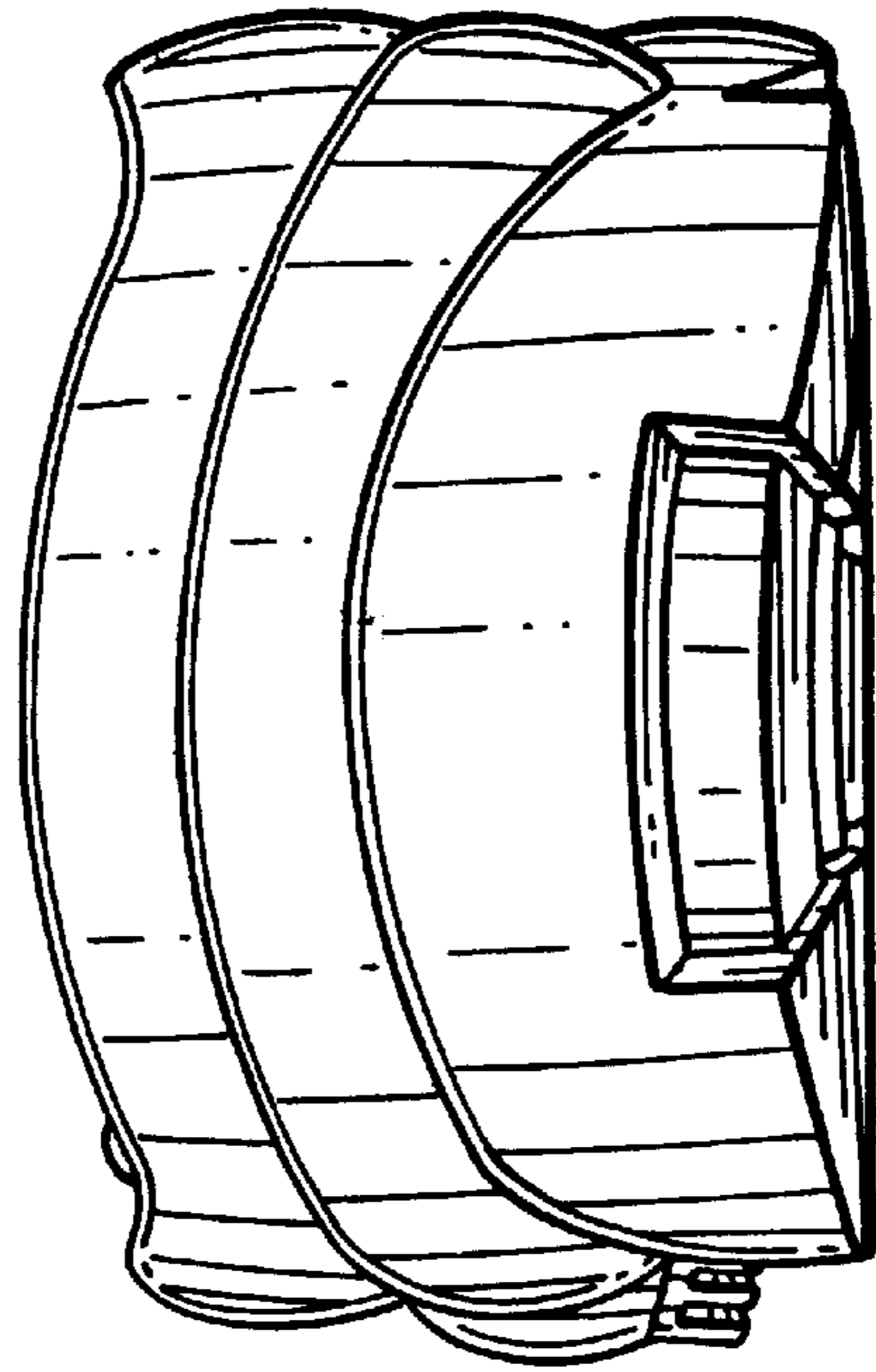

FIG. 4

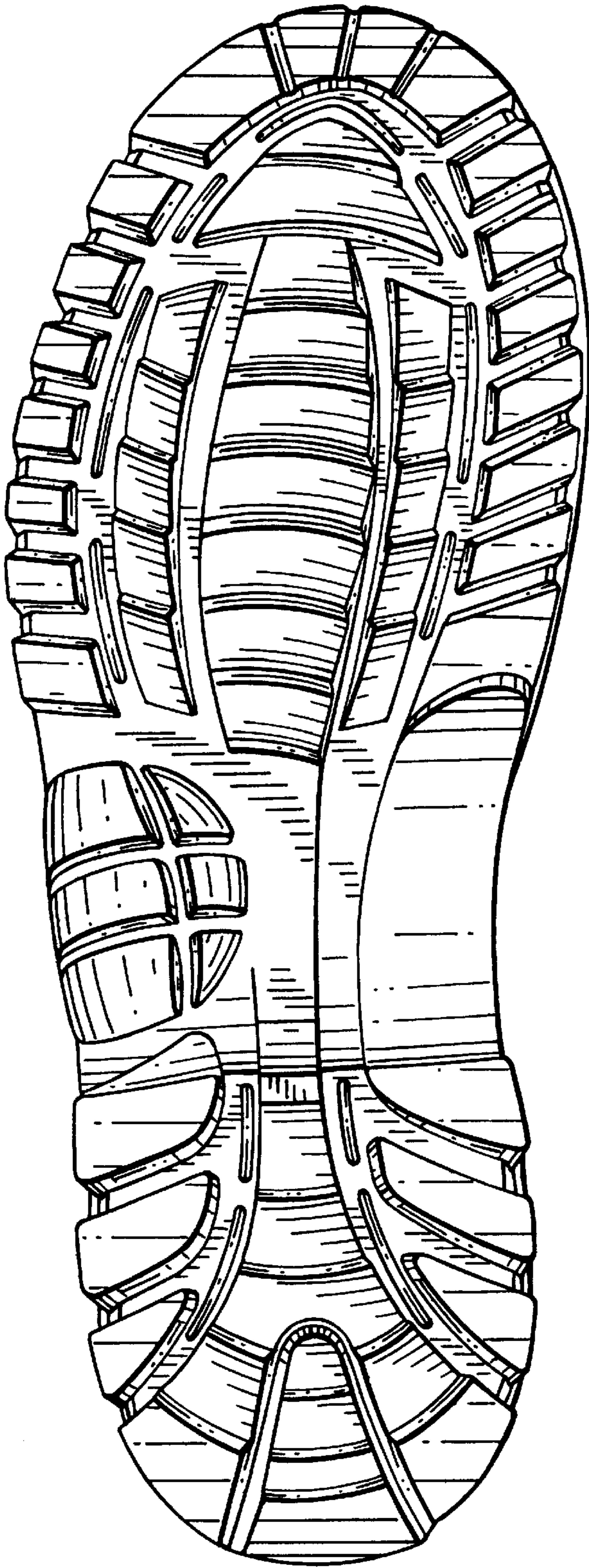

FIG. 5

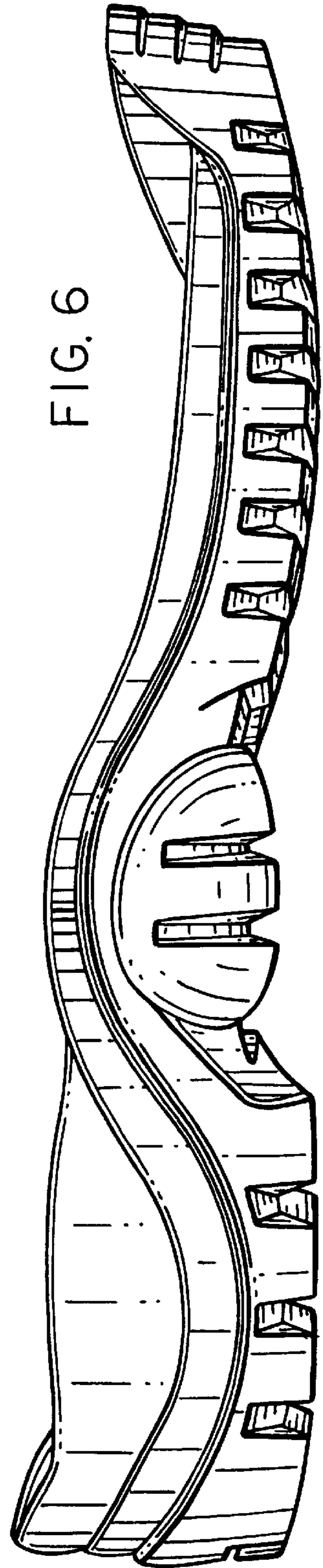

FIG. 6