



US00D414545S

United States Patent [19]

Hayashi et al.

[11] Patent Number: Des. 414,545

[45] Date of Patent: ** Sep. 28, 1999

[54] ELECTROMAGNETIC VALVE ASSEMBLY

[75] Inventors: **Bunya Hayashi; Takumi Matsumoto; Masaru Narita**, all of Yawara-mura, Japan

[73] Assignee: **SMC Corporation**, Tokyo, Japan

[**] Term: **14 Years**

[21] Appl. No.: **29/064,828**

[22] Filed: **Jan. 10, 1997**

[30] Foreign Application Priority Data

Jul. 11, 1996 [JP] Japan 8-20708

[51] LOC (6) Cl. **23-01**

[52] U.S. Cl. **D23/233**

[58] Field of Search D23/233, 247, D23/248; 137/884, 625.64, 269, 271, 343

[56] References Cited

U.S. PATENT DOCUMENTS

D. 295,048	4/1988	Kanno	D15/7
D. 389,560	1/1998	Hayashi et al.	D23/233
3,215,158	11/1965	Bass, Jr. et al.	137/269
3,465,772	9/1969	Monge et al.	137/815
5,333,647	8/1994	Fukano et al.	137/884
5,447,176	9/1995	Asou et al.	137/625.66

5,459,953	10/1995	Fukano et al.	137/625.64
5,462,087	10/1995	Fukano et al.	137/884
5,529,088	6/1996	Asou	137/343
5,664,604	9/1997	Sato et al.	137/884
5,706,858	1/1998	Miyazoe et al.	137/884

FOREIGN PATENT DOCUMENTS

203780 8/1989 Japan 137/884

Primary Examiner—Ted Shooman

Assistant Examiner—C Tuttle

Attorney, Agent, or Firm—Oblon, Spivak, McClelland, Maier & Neustadt, P.C.

[57] CLAIM

The ornamental design for an electromagnetic valve assembly, as shown and described.

DESCRIPTION

FIG. 1 is a front elevational view of electromagnetic valve assembly, embodying our new design; FIG. 2 is a rear elevational view thereof; FIG. 3 is a right side elevational view thereof; FIG. 4 is a left side elevational view thereof; FIG. 5 is a top plan view thereof; FIG. 6 is a bottom plan view thereof; and, FIG. 7 is a top, front and left side perspective view shown on a reduced scale.

1 Claim, 4 Drawing Sheets

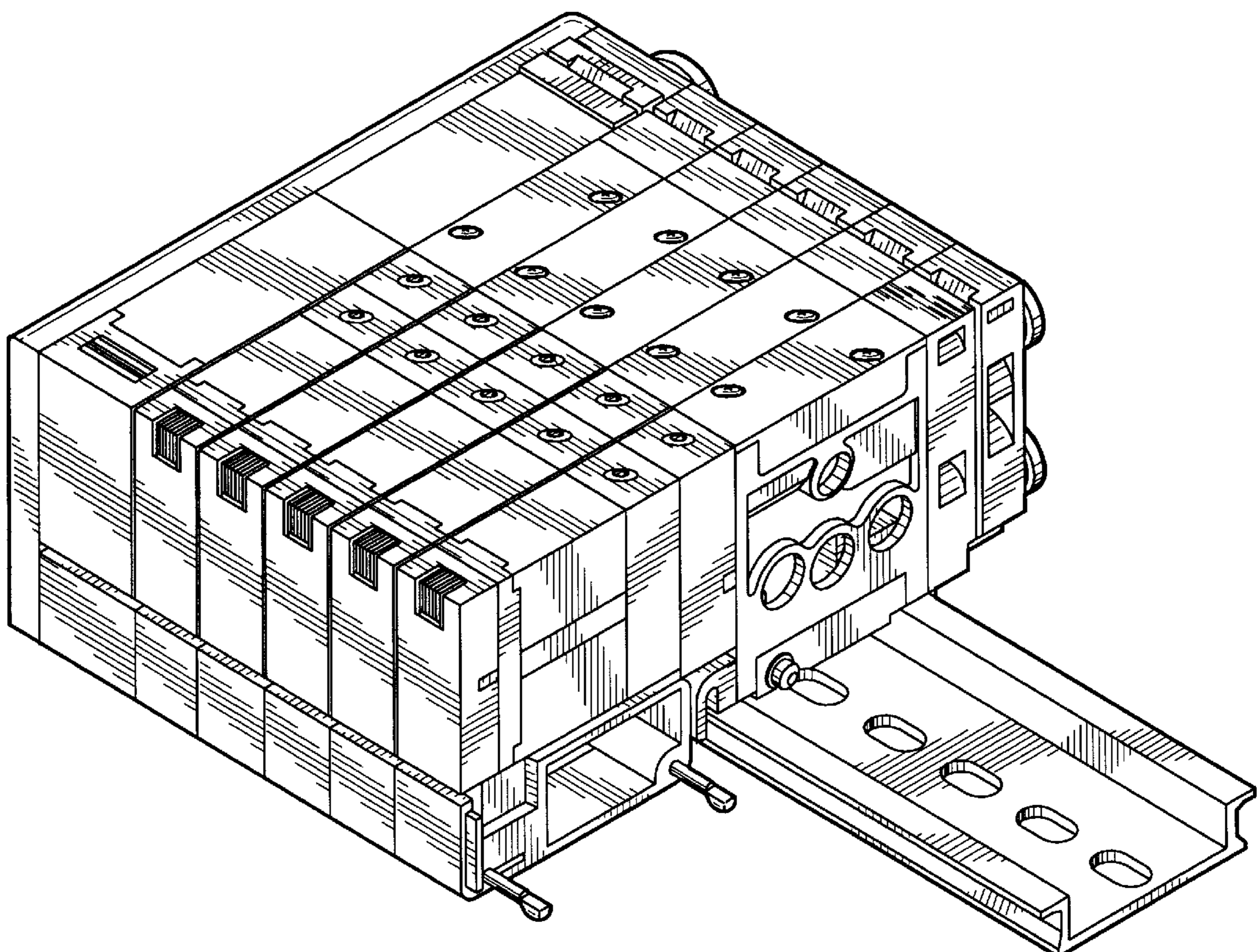

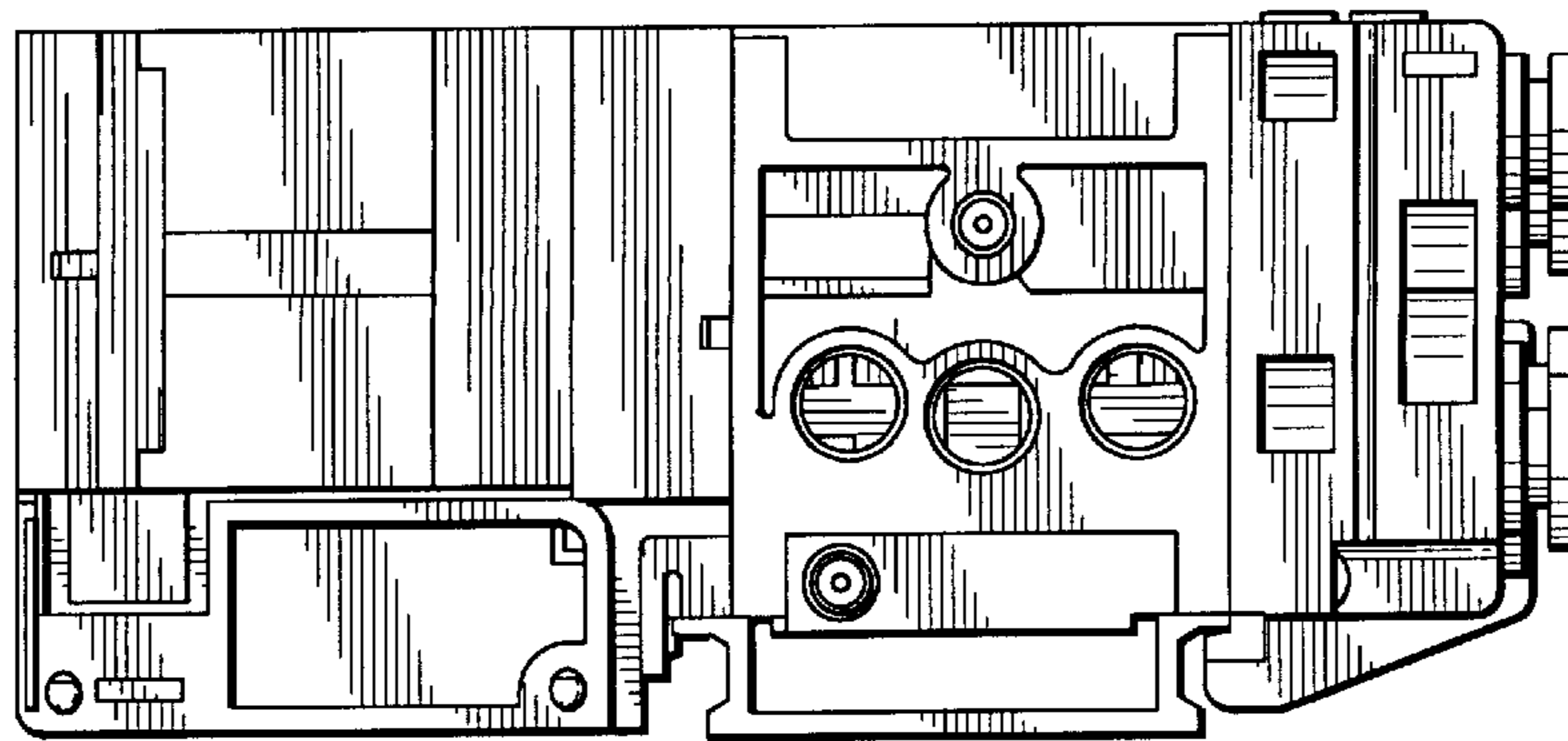

FIG. 1

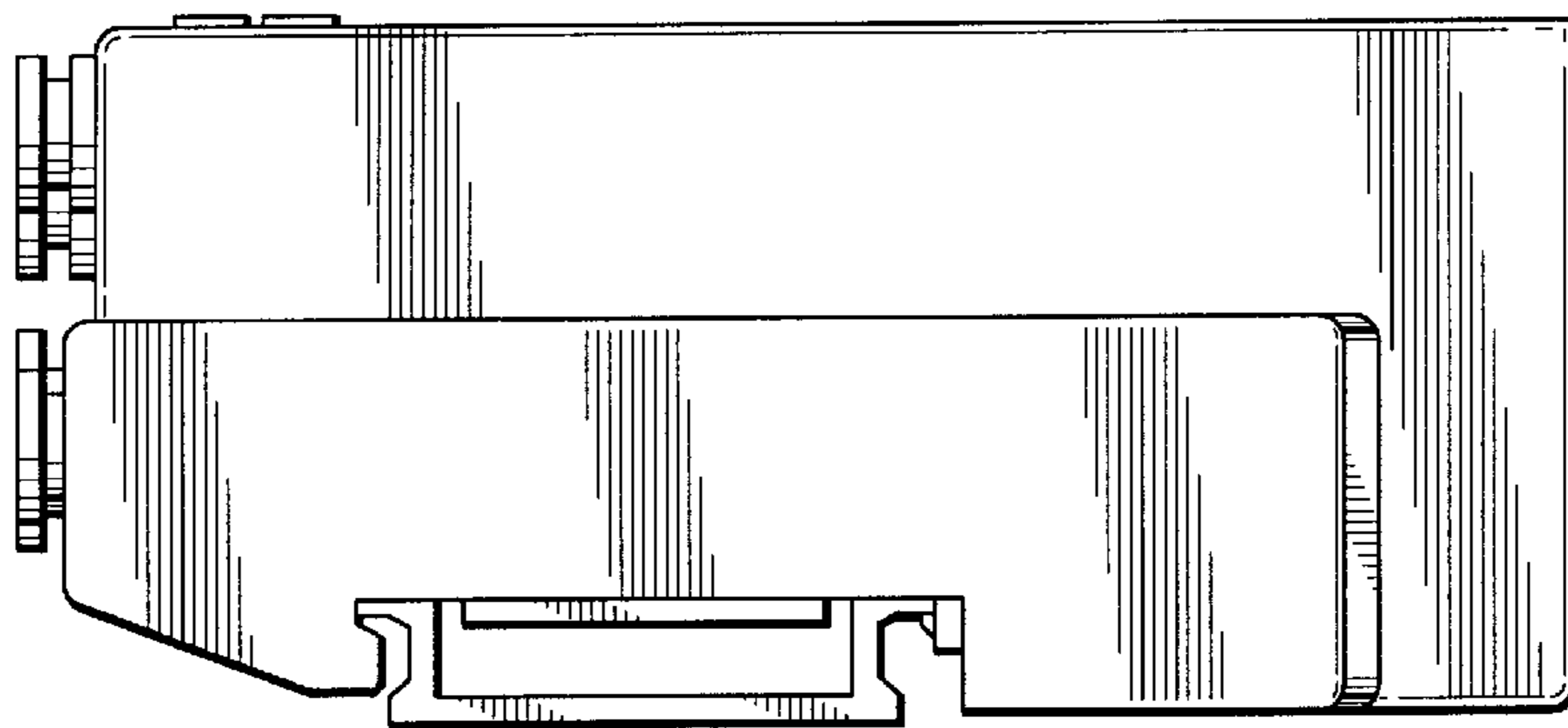

FIG. 2

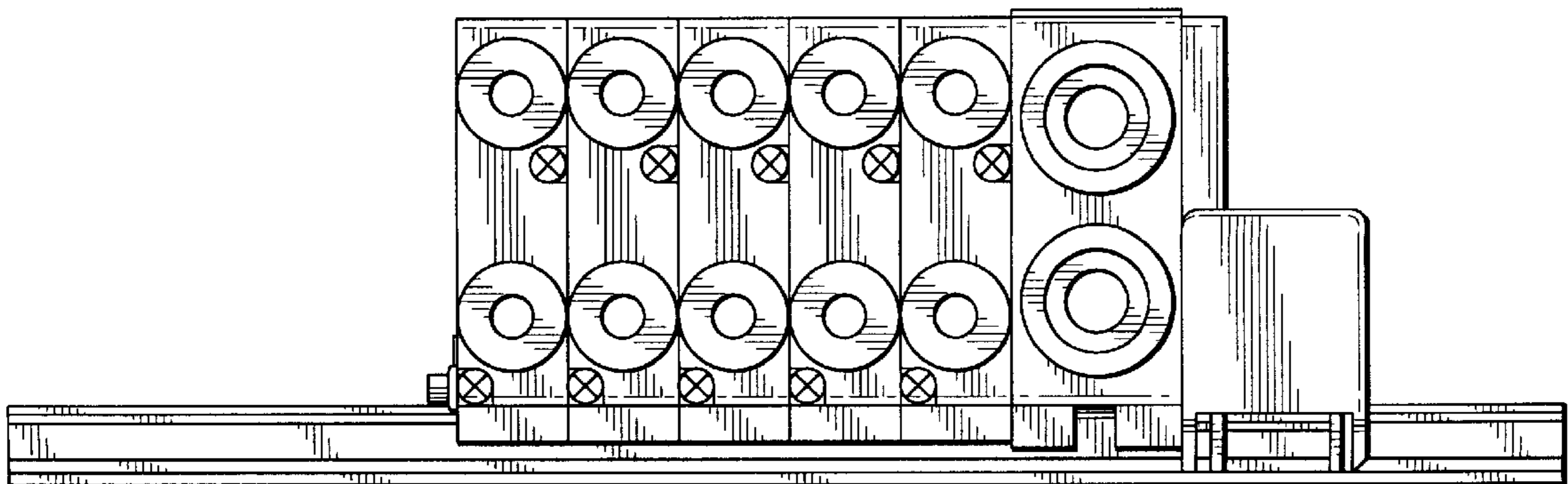

FIG. 3

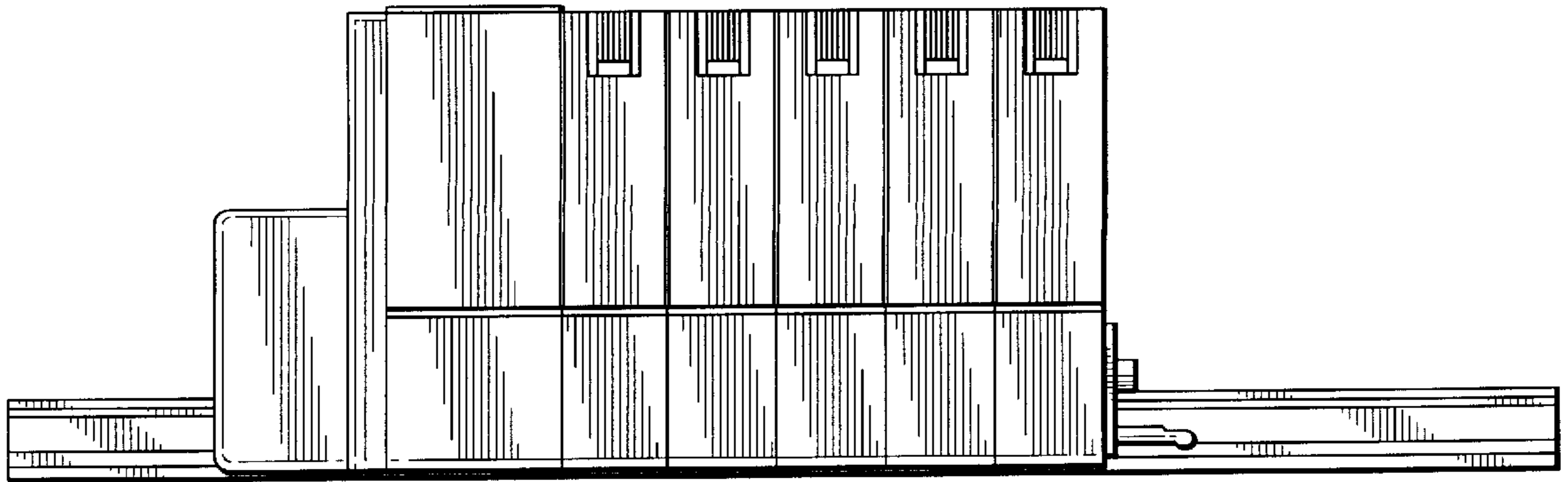

FIG. 4

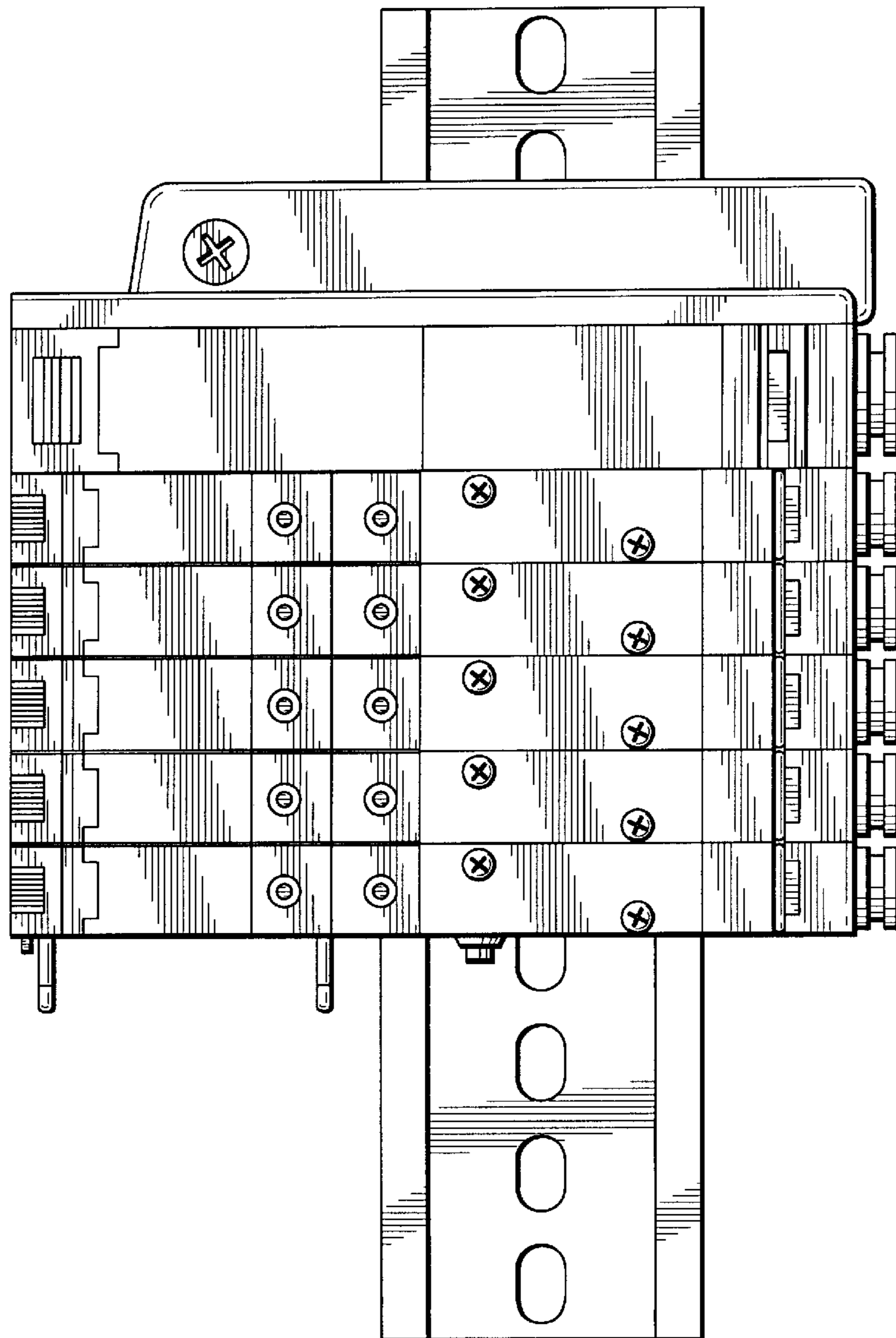

FIG. 5

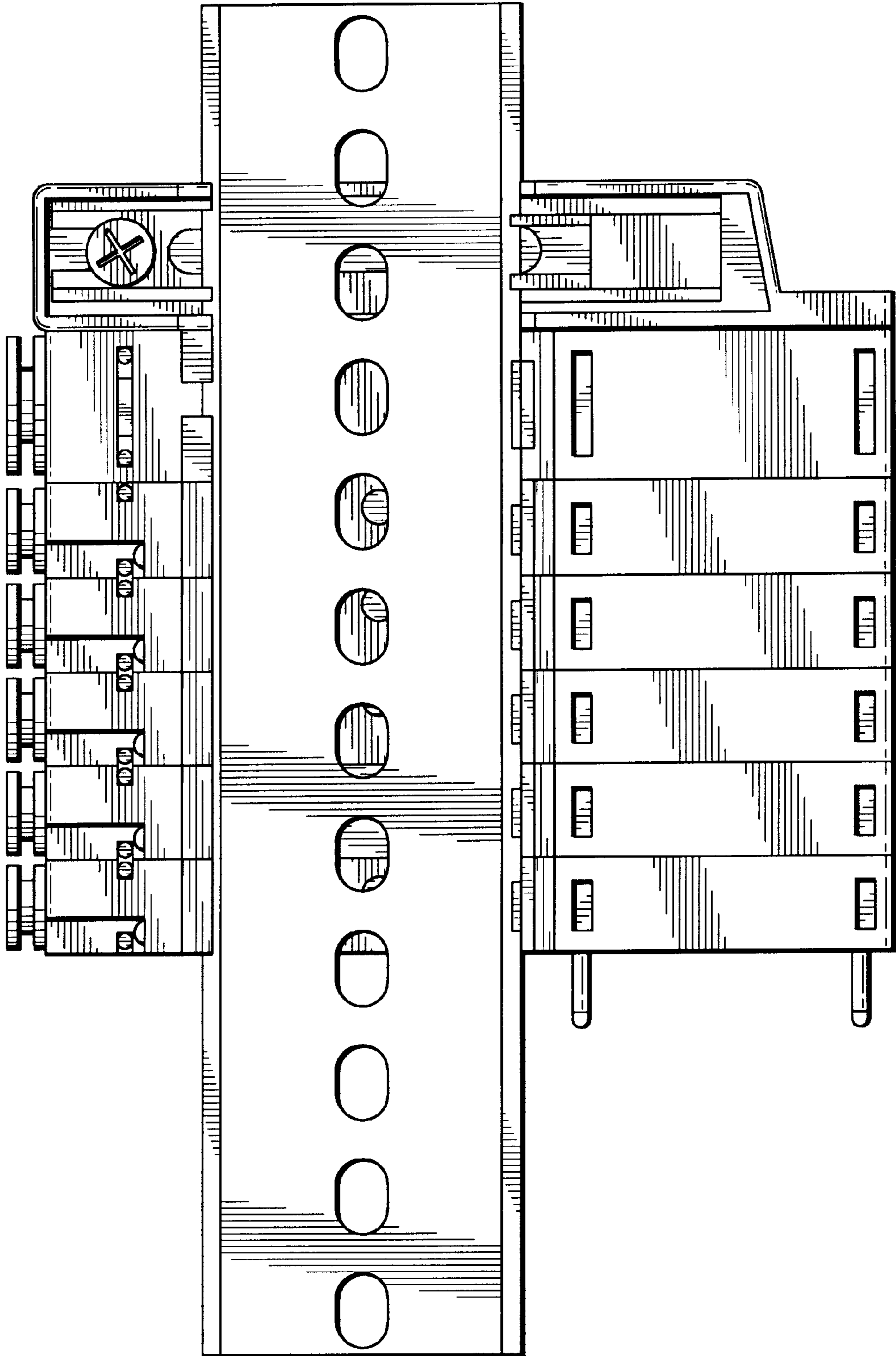

FIG. 6

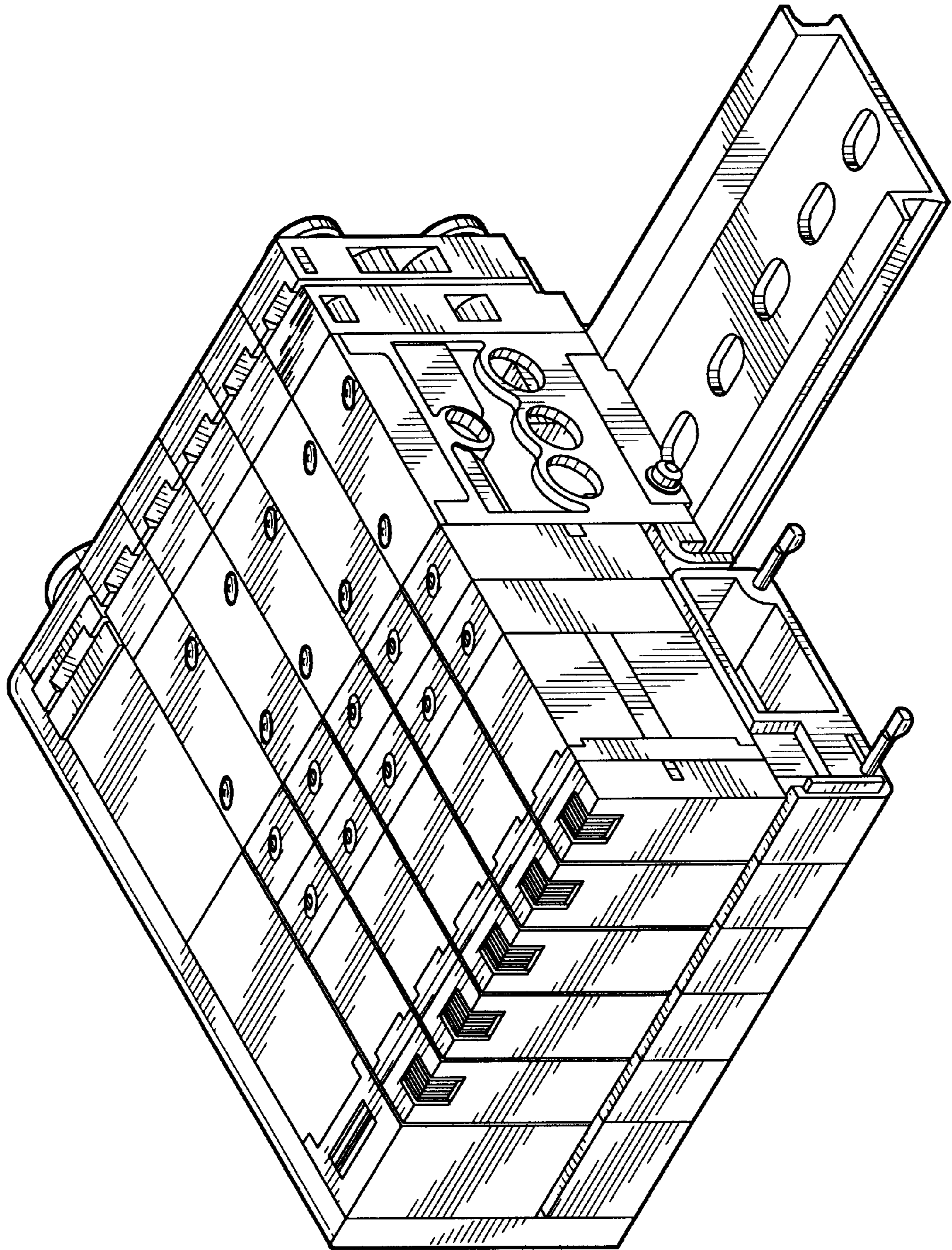

FIG. 7