



US00D414523S

United States Patent [19] Fai

[11] Patent Number: Des. 414,523

[45] Date of Patent: ** Sep. 28, 1999

[54] **COMPUTER GAME**

[75] Inventor: **Au Yeung Siu Fai**, Kowloon, The Hong Kong Special Administrative Region of the People's Republic of China

[73] Assignee: **Watercore Limited**, New Territories, The Hong Kong Special Administrative Region of the People's Republic of China

[**] Term: **14 Years**

[21] Appl. No.: **29/090,695**

[22] Filed: **Jul. 14, 1998**

[51] **LOC (6) Cl.** **21-01**

[52] **U.S. Cl.** **D21/329**

[58] **Field of Search** D14/117.1, 117.9, D14/114; D21/324, 333, 328; 463/1, 2, 29-38, 46, 47; 273/148 B

[56] **References Cited**

U.S. PATENT DOCUMENTS

- D. 377,198 1/1997 Oikawa et al. D14/117.1
- D. 386,544 11/1997 Kajikawa et al. D14/117.1

- D. 391,998 3/1998 Jwo D14/117.9
- D. 393,291 4/1998 Kung D14/117.9
- D. 402,976 12/1998 Heung D14/117.9
- 5,700,194 12/1997 Hsien 273/148 B X
- 5,716,274 2/1998 Goto et al. 463/37
- 5,759,100 6/1998 Nakanishi 463/44 X
- 5,820,462 10/1998 Yokoi et al. 463/37

OTHER PUBLICATIONS

HongKong Enterprise, p. 269, Oct. 1992.

Primary Examiner—Prabhakar Deshmukh
Attorney, Agent, or Firm—Abelman, Frayne & Schwab

[57] **CLAIM**

I claim the ornamental design for a computer game, as shown and described.

DESCRIPTION

- FIG. 1 is a front perspective view thereof.
- FIG. 2 is a front view thereof.
- FIG. 3 is a rear view thereof.
- FIG. 4 is a top view thereof.
- FIG. 5 is a bottom view thereof.
- FIG. 6 is a right side view thereof; and,
- FIG. 7 is a left side view thereof.

1 Claim, 3 Drawing Sheets

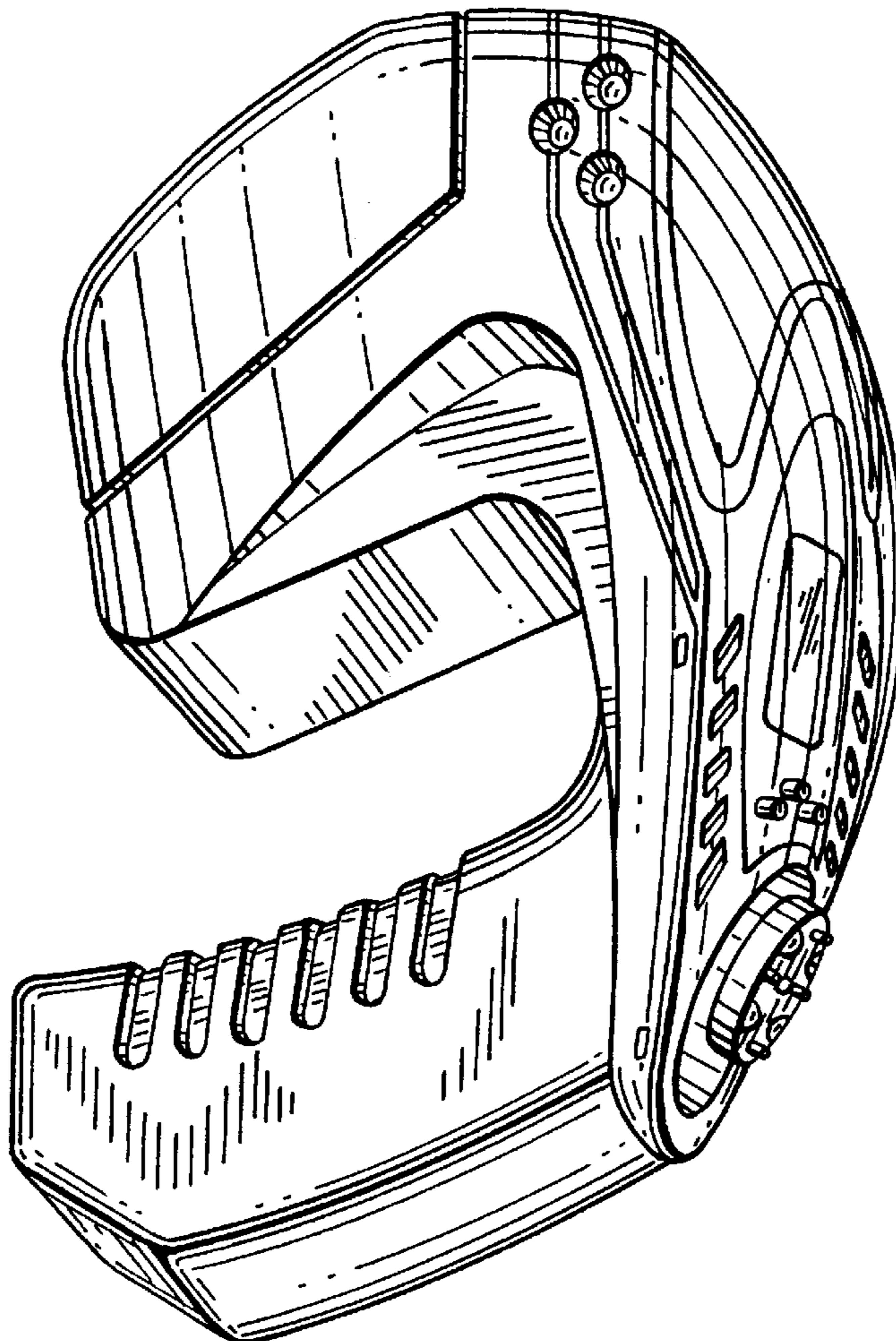

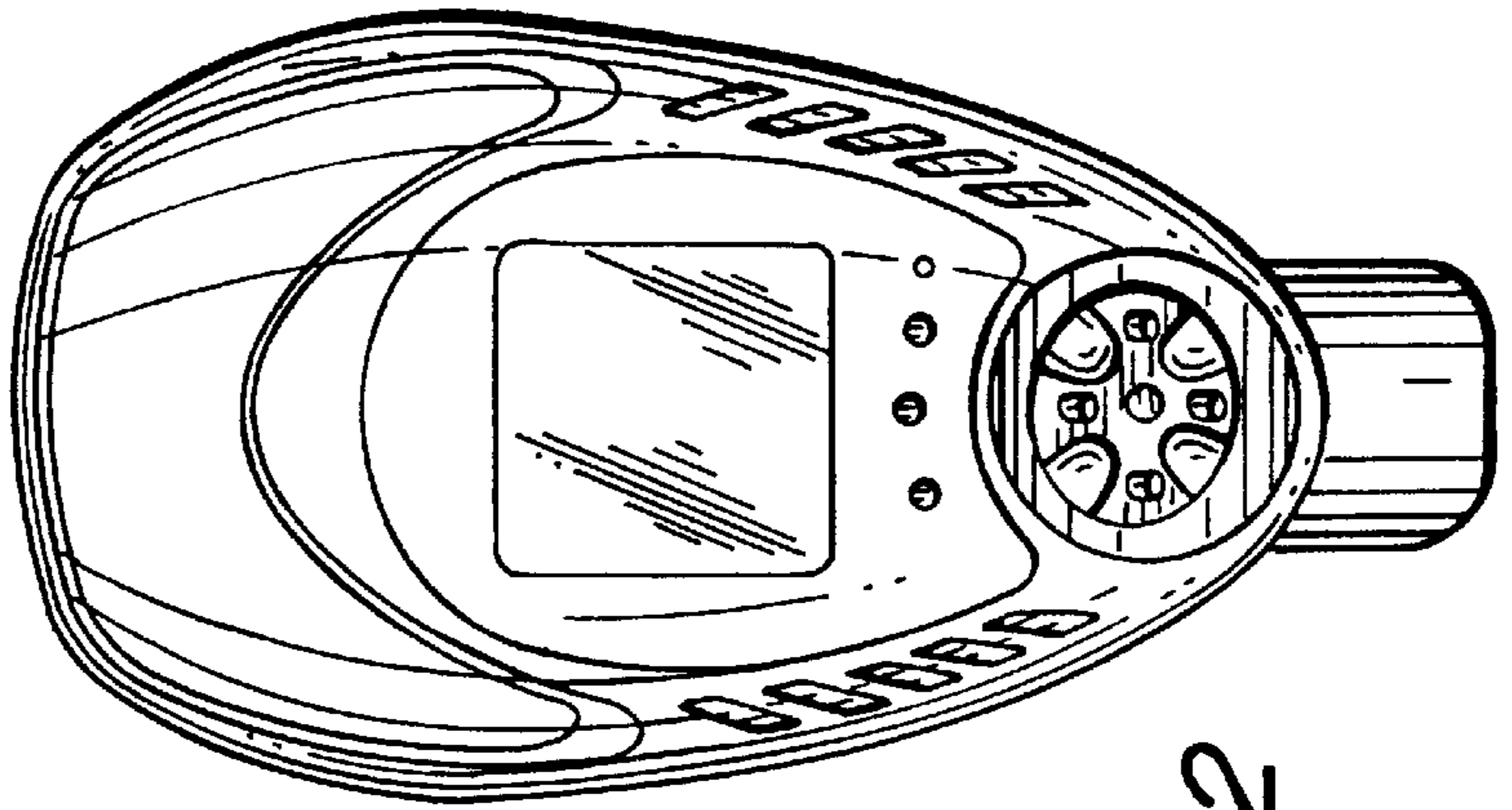

FIG. 2

FIG. 1

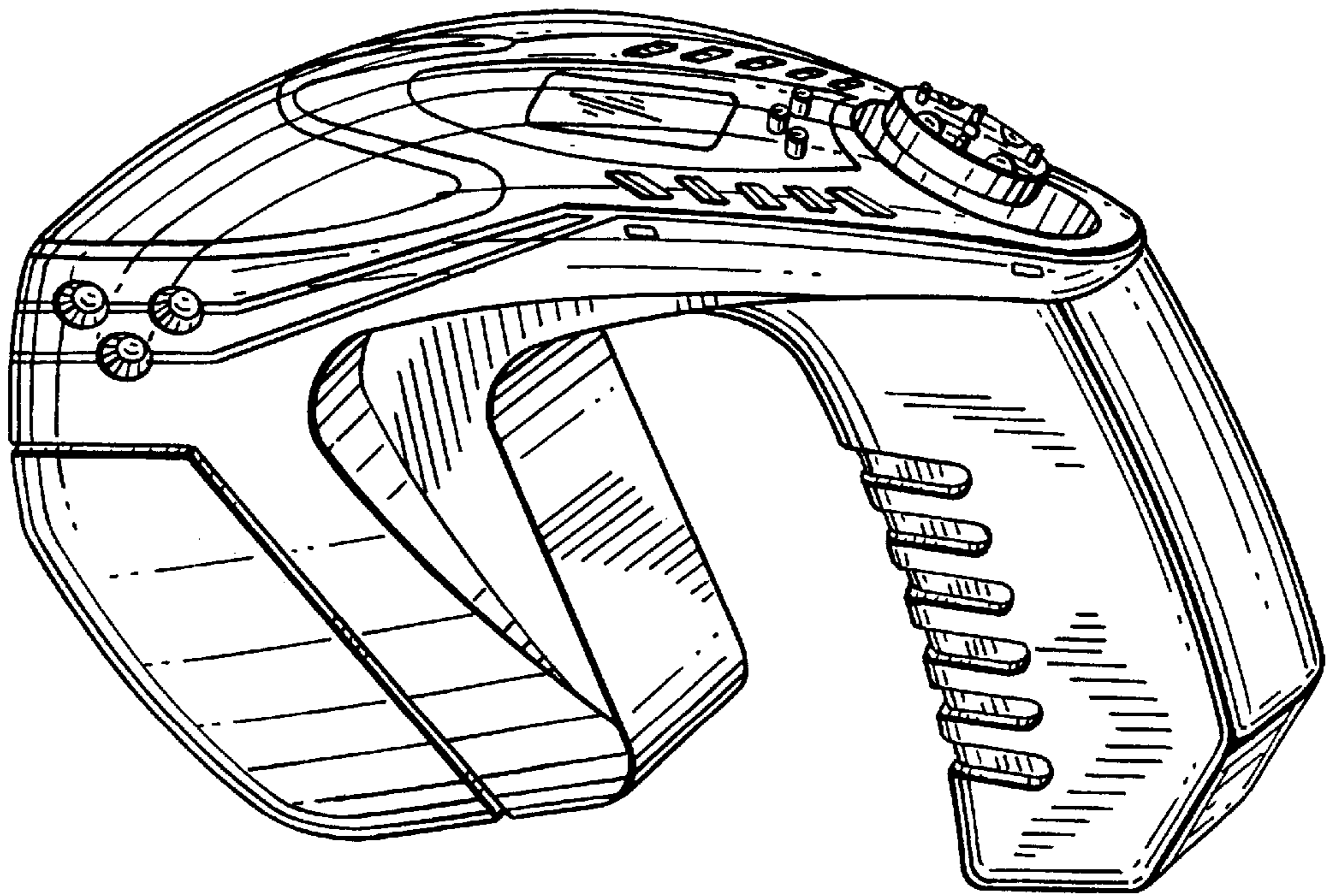

FIG. 4

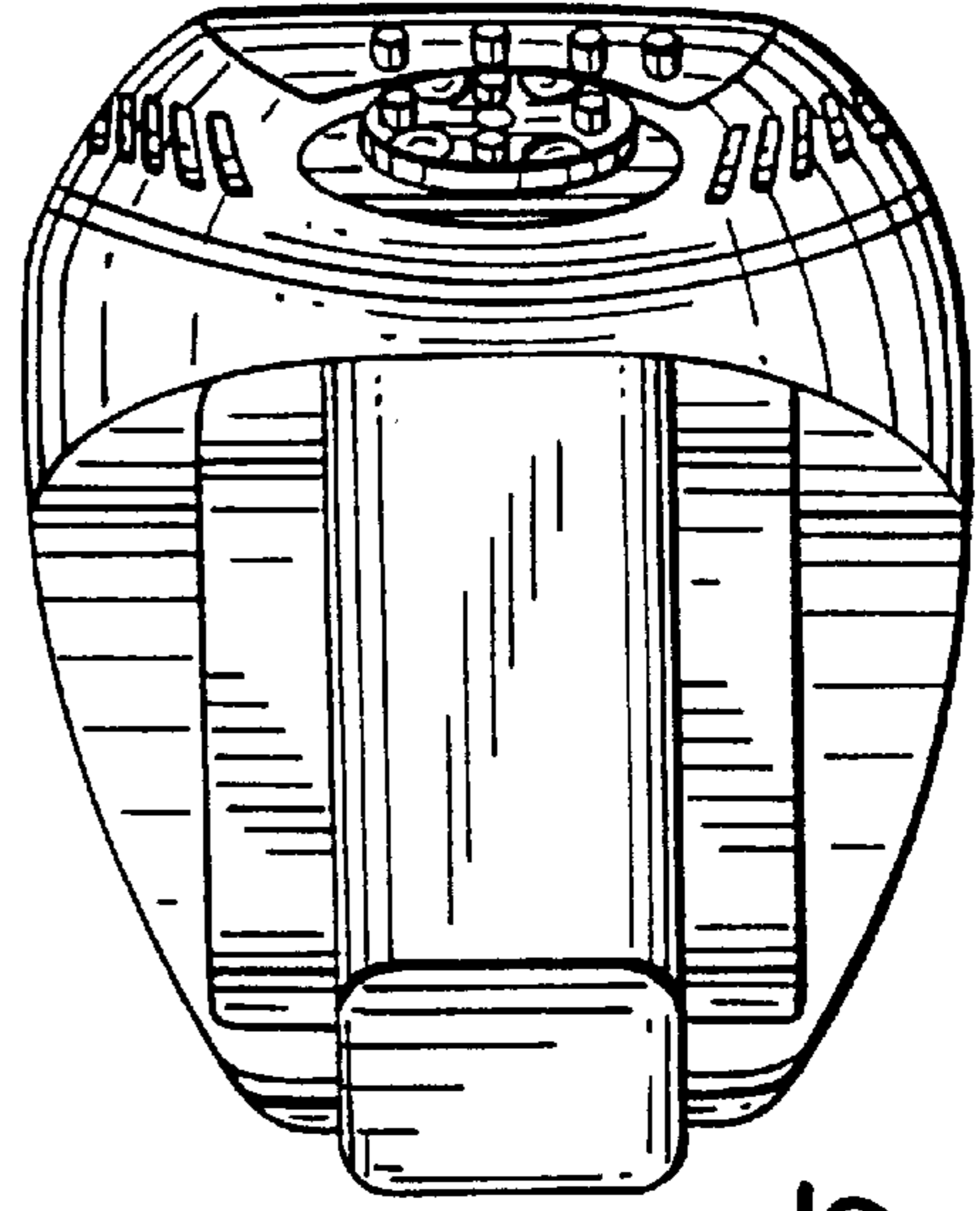
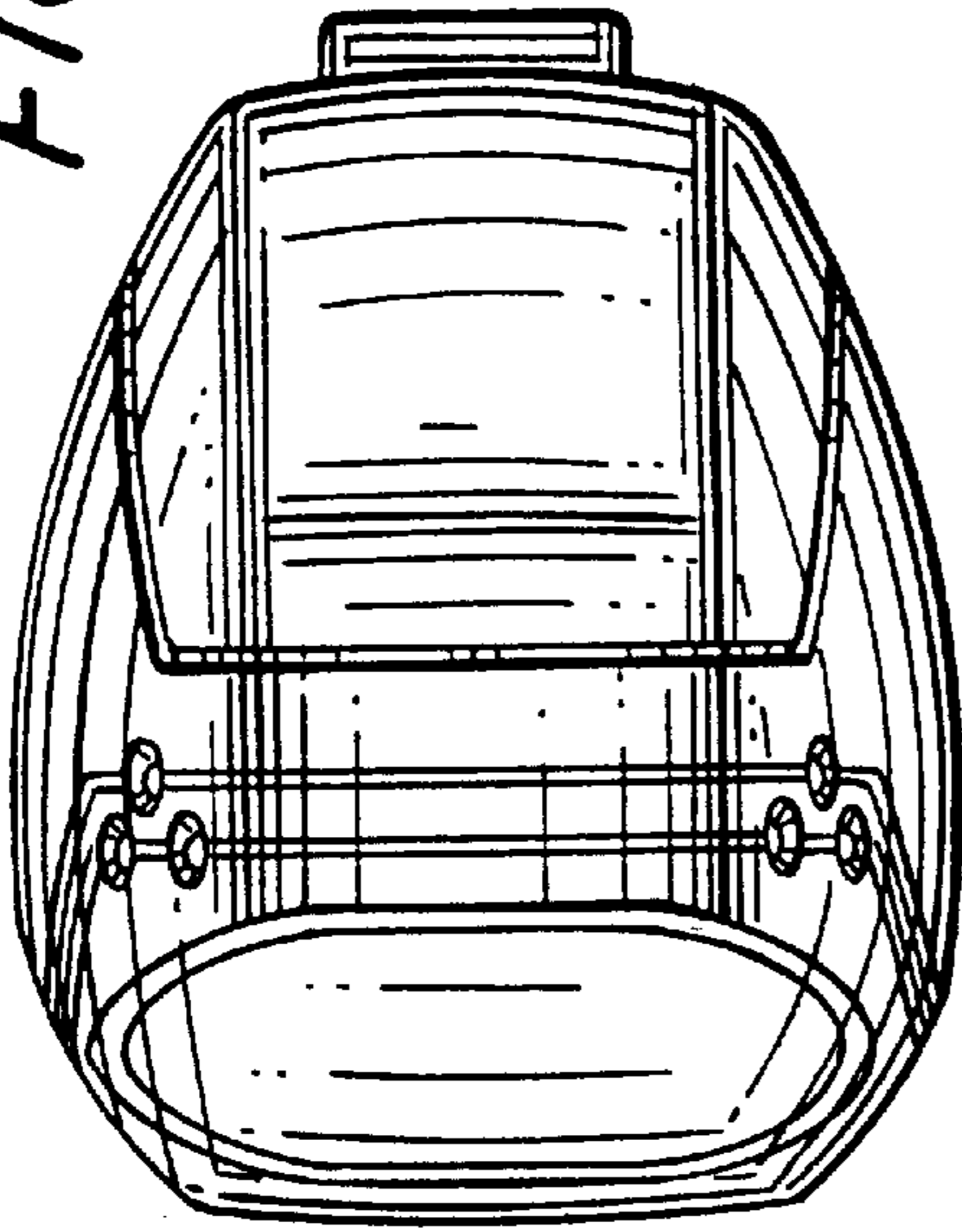

FIG. 5

FIG. 3

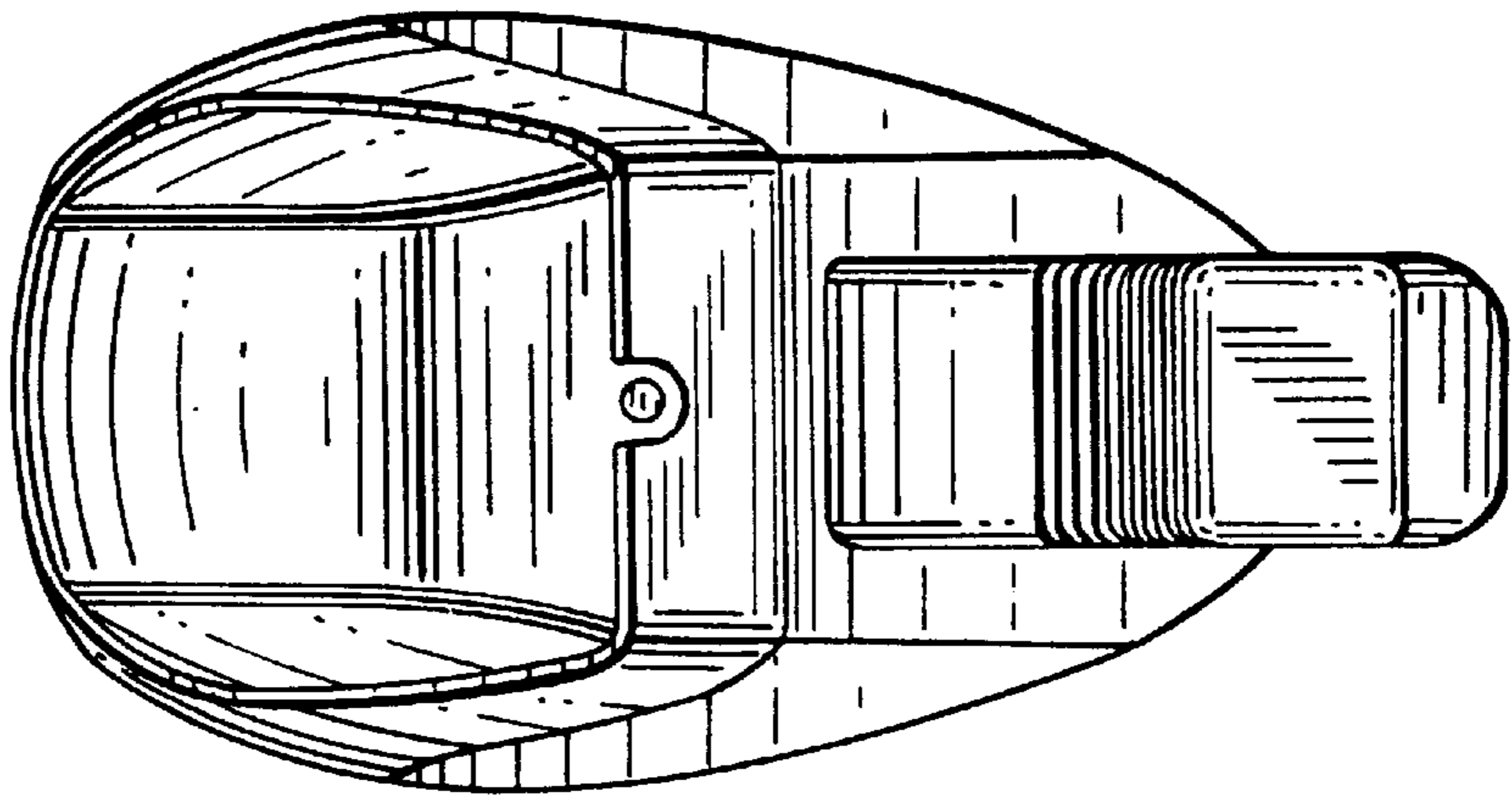

FIG. 7

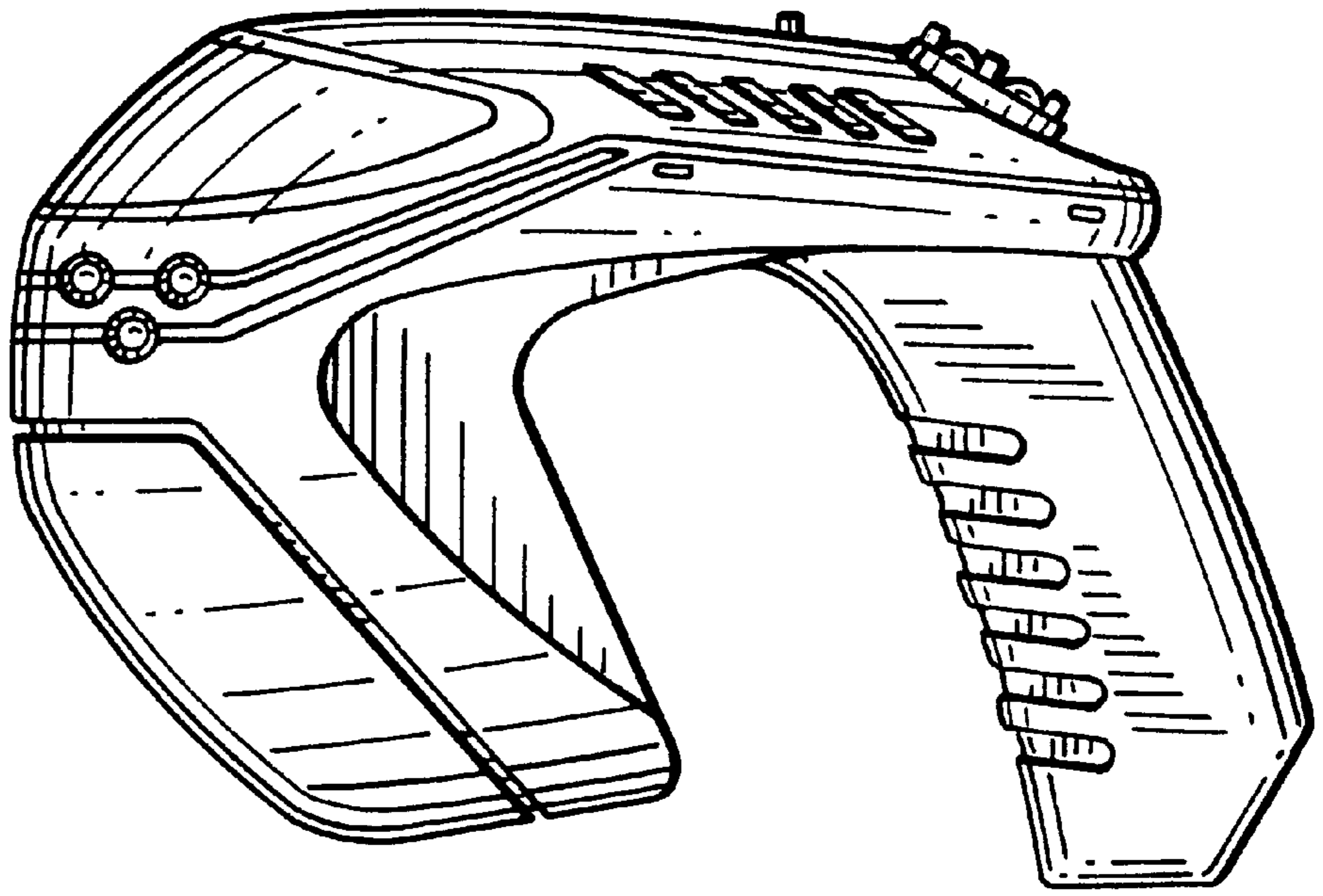

FIG. 6

