



US00D414507S

# United States Patent [19]

Nozawa et al.

[11] **Patent Number: Des. 414,507**

[45] **Date of Patent: \*\* Sep. 28, 1999**

[54] **TONER CARTRIDGE**

[75] Inventors: **Ken Nozawa; Atsushi Kurabayashi; Yoshiharu Momiyama**, all of Tokyo, Japan

[73] Assignee: **OKI Data Corporation**, Tokyo, Japan

[\*\*] Term: **14 Years**

[21] Appl. No.: **29/079,521**

[22] Filed: **Nov. 19, 1997**

[51] **LOC (6) Cl. .... 16-03**

[52] **U.S. Cl. .... D18/43**

[58] **Field of Search** ..... D18/36, 40, 43, D18/56; 399/24, 25, 31, 130, 262; 222/DIG. 1, 166, 240, 325

[56] **References Cited**

**U.S. PATENT DOCUMENTS**

- D. 356,815 3/1995 Nakajima et al. .... D18/43
- D. 379,634 6/1997 Ootani et al. .... D18/43
- D. 389,860 1/1998 Nakajima et al. .... D18/43

*Primary Examiner*—Caron D. Veynar

*Attorney, Agent, or Firm*—Ladas & Parry

[57] **CLAIM**

We claim the ornamental design for toner cartridge, as shown and described.

**DESCRIPTION**

FIG. 1 is a front view of toner cartridge showing the new design;

FIG. 2 is a rear view of FIG. 1;

FIG. 3 is a left side view of FIG. 1;

FIG. 4 is a right side view of FIG. 1;

FIG. 5 is a top view of FIG. 1;

FIG. 6 is a bottom view of FIG. 1; and,

FIG. 7 is a perspective view of the toner cartridge, showing the new design.

A description of the article to which the design is to be applied.

The present article is a toner cartridge to be set in an image forming unit which forms an image in an electrophotographic process for the use of a copier or printer.

The toner cartridges are consumables which are sold separately from the printers or image drums.

**1 Claim, 3 Drawing Sheets**

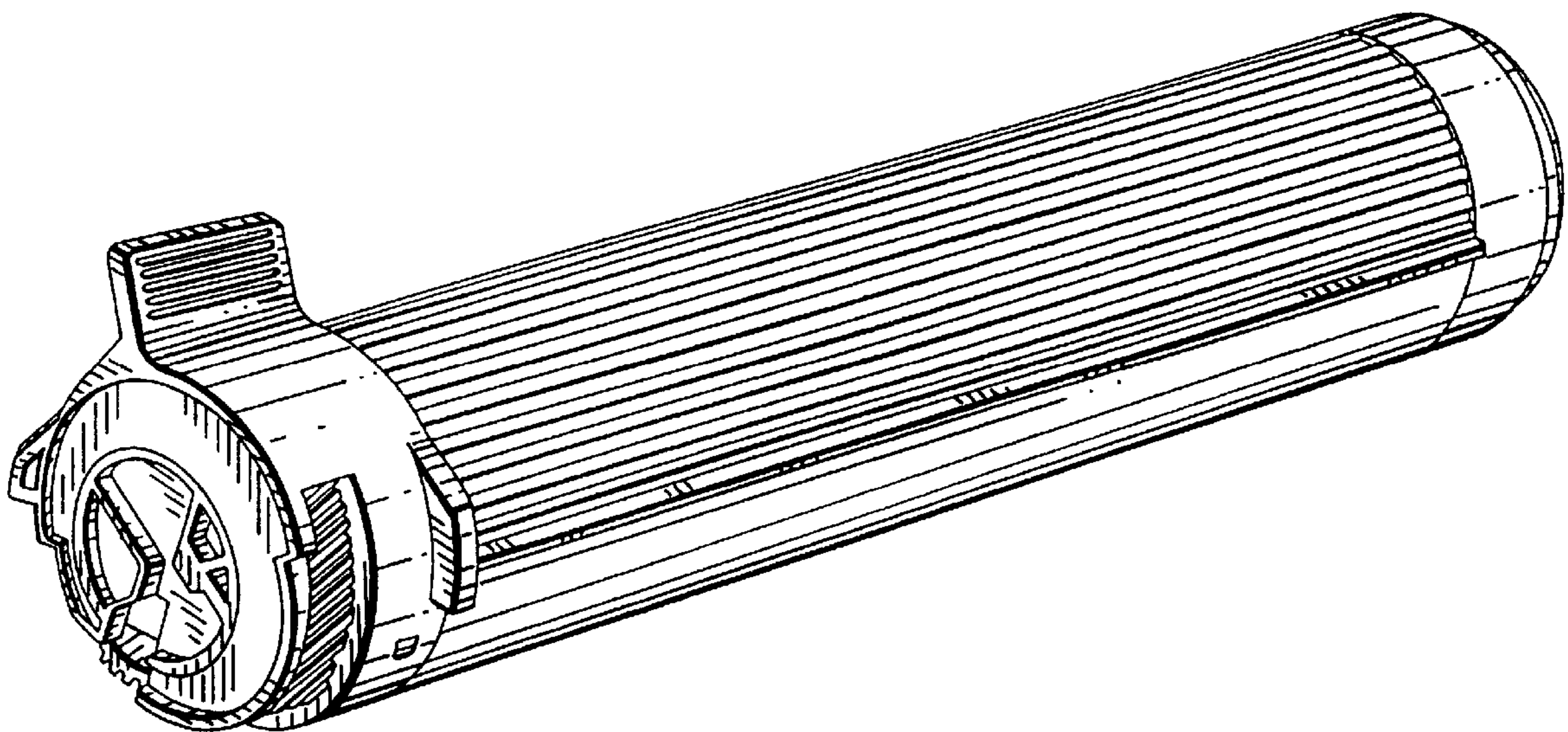

FIG. 3

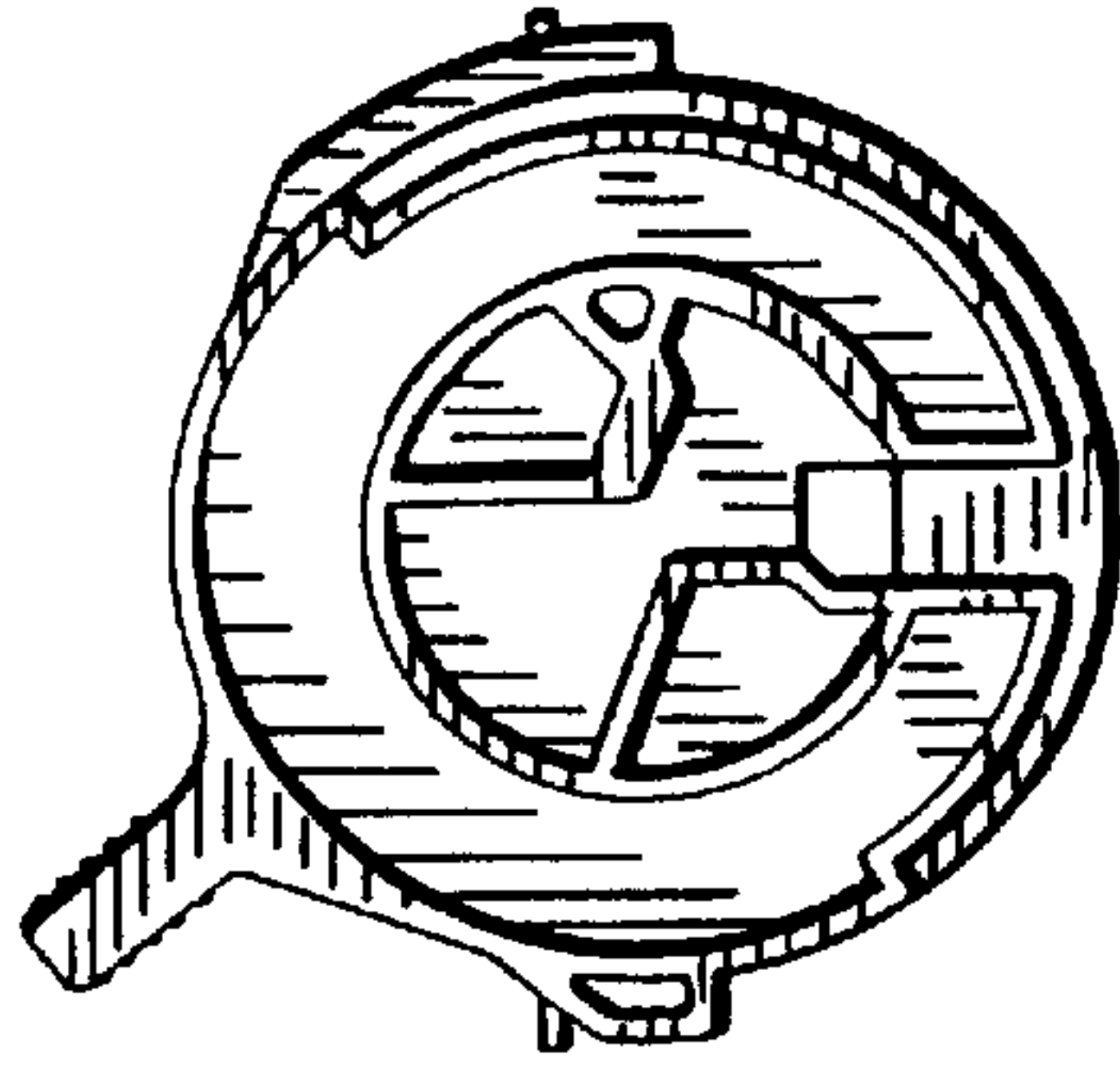

FIG. 4

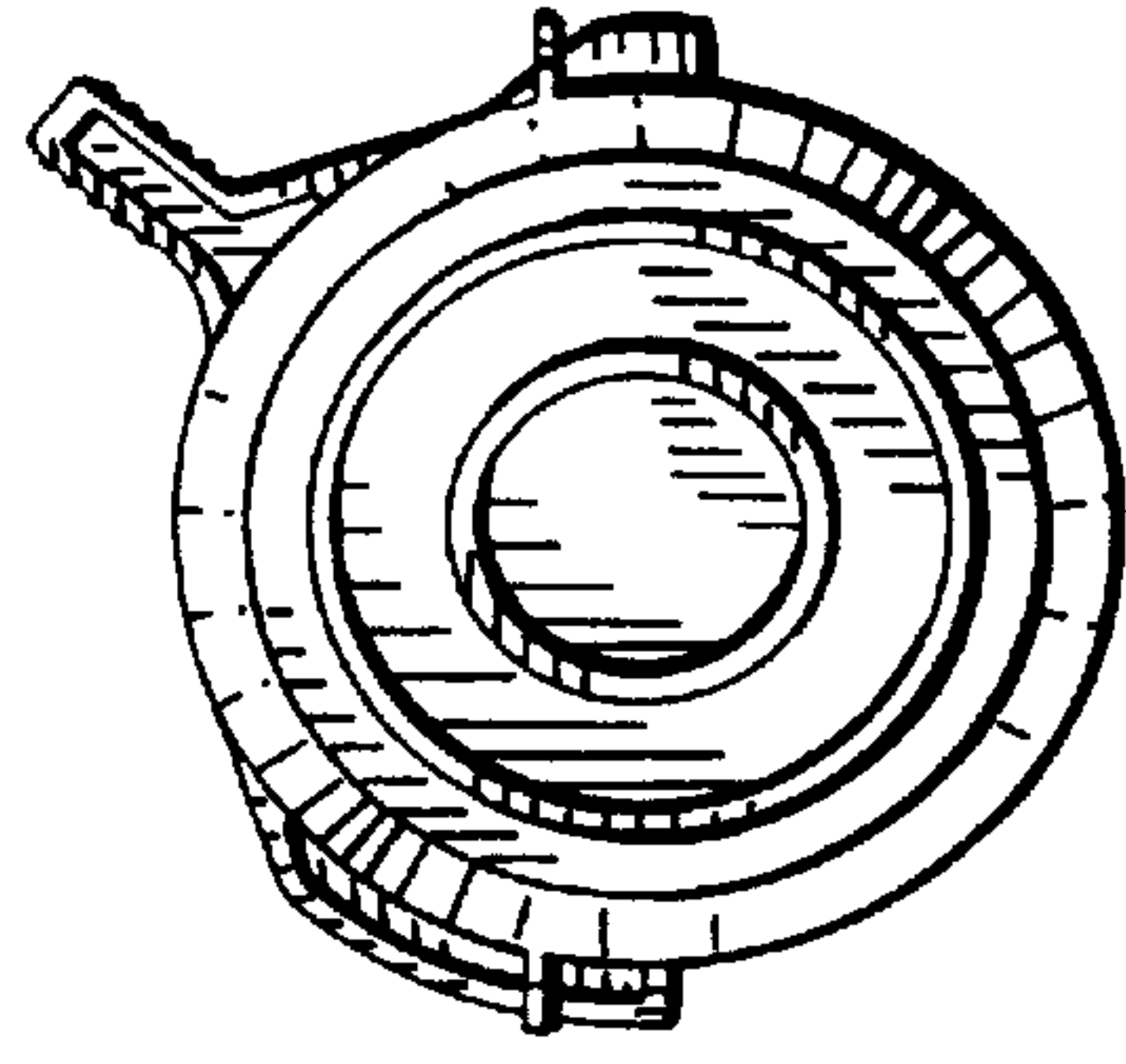

FIG. 1

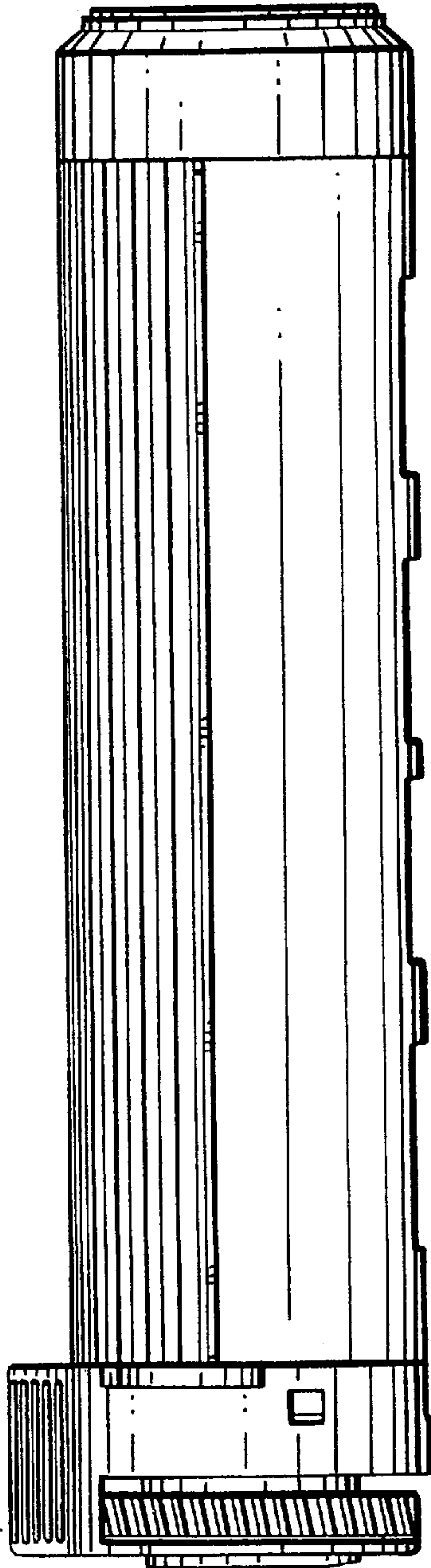

FIG. 2

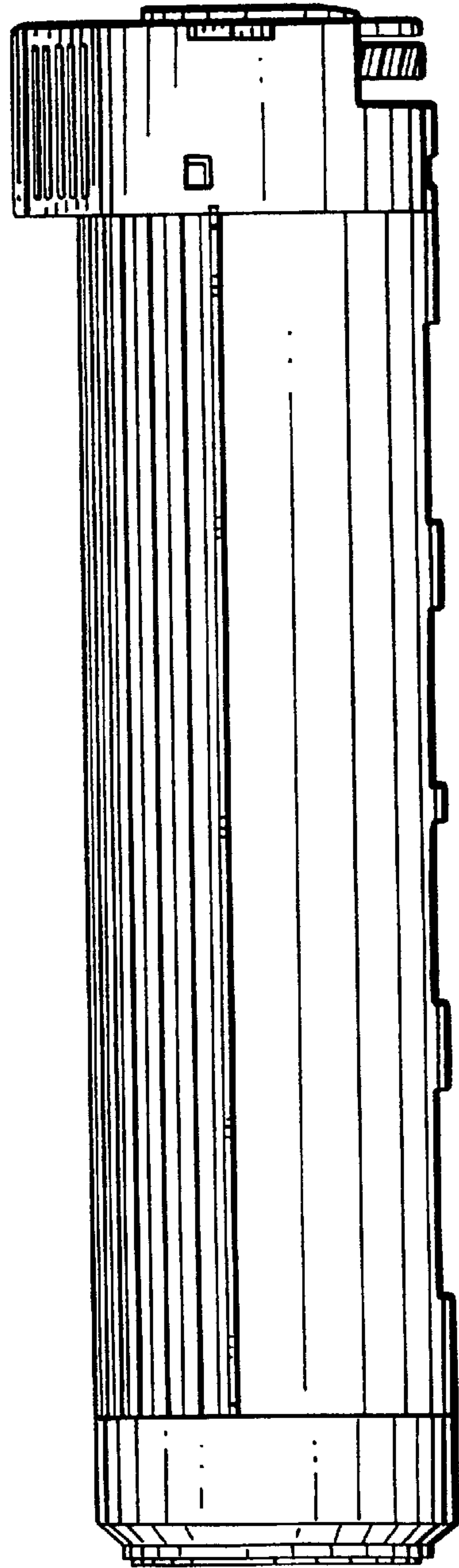

FIG. 5

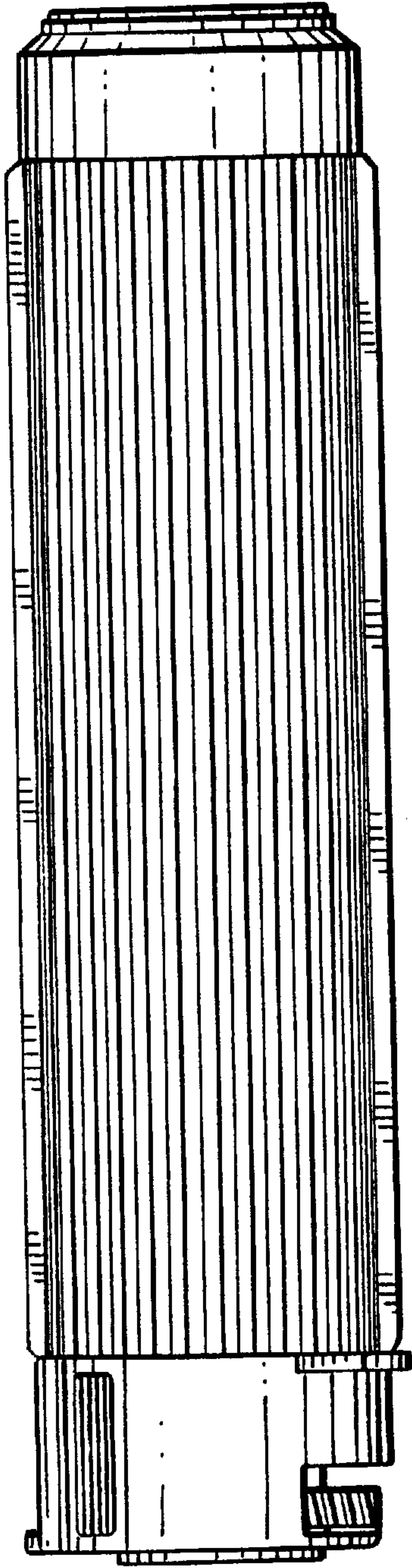

FIG. 6

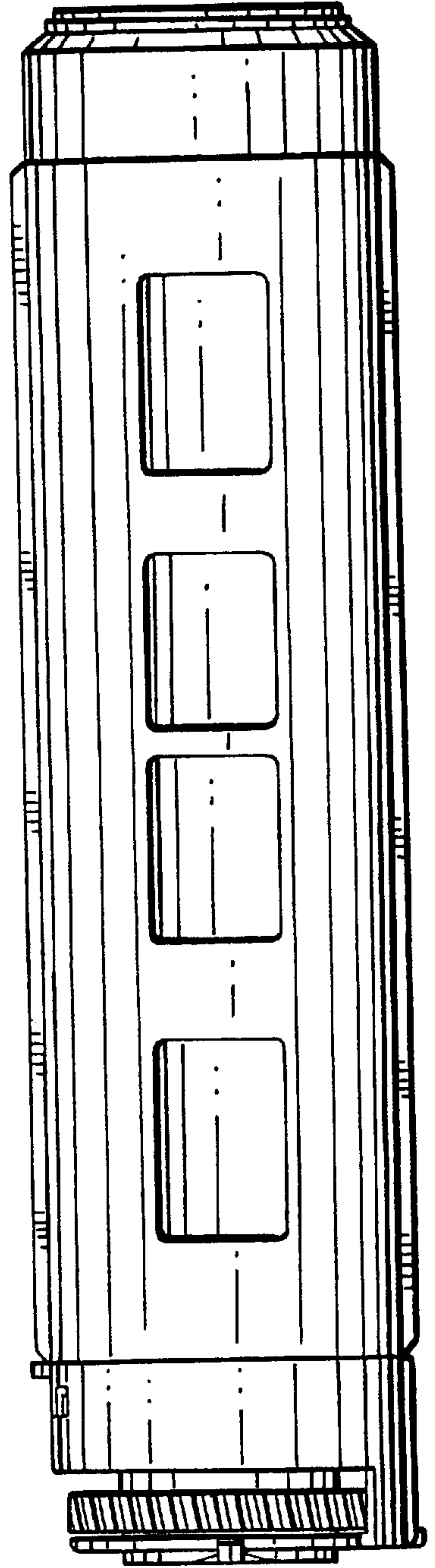



FIG. 7

