



US00D414443S

United States Patent [19]
Nobile

[11] **Patent Number: Des. 414,443**

[45] **Date of Patent: ** Sep. 28, 1999**

[54] **MUSHROOM GROWING TRAY**

5,463,858 11/1995 Ciuffetelli 47/1.1 X

[76] Inventor: **John R. Nobile**, 65 Forest Ave.,
Fairfield, Conn. 06430

Primary Examiner—Doris V. Coles
Assistant Examiner—Linda Brooks
Attorney, Agent, or Firm—Fattibene & Fattibene; Paul A.
Fattibene; Arthur T. Fattibene

[**] Term: **14 Years**

[21] Appl. No.: **29/086,272**

[57] **CLAIM**

[22] Filed: **Apr. 9, 1998**

The ornamental design for a mushroom growing tray, as shown.

[51] **LOC (6) Cl.** **11-02**

[52] **U.S. Cl.** **D11/156**

[58] **Field of Search** D11/143-148,
D11/155, 156, 164; D6/403, 405, 469;
47/1.1, 65.5, 65.7, 65.9, 68, 69, 41.11-41.15;
108/26; 206/423

DESCRIPTION

[56] **References Cited**

U.S. PATENT DOCUMENTS

- D. 219,669 1/1971 Hasselbach D11/156
- D. 334,728 4/1993 Ishiyama et al. D11/155
- 4,337,594 7/1982 Hanacek et al. 47/1.1

FIG. 1 is a perspective view of a mushroom growing tray showing my new design;
FIG. 2 is a top plan view thereof, on a reduced scale;
FIG. 3 is a right side elevational view thereof of FIG. 2;
FIG. 4 is a front elevational view of FIG. 2;
FIG. 5 is a left side elevational view of FIG. 2;
FIG. 6 is a rear elevational view of FIG. 2; and,
FIG. 7 is a bottom plan view of FIG. 2.

1 Claim, 3 Drawing Sheets

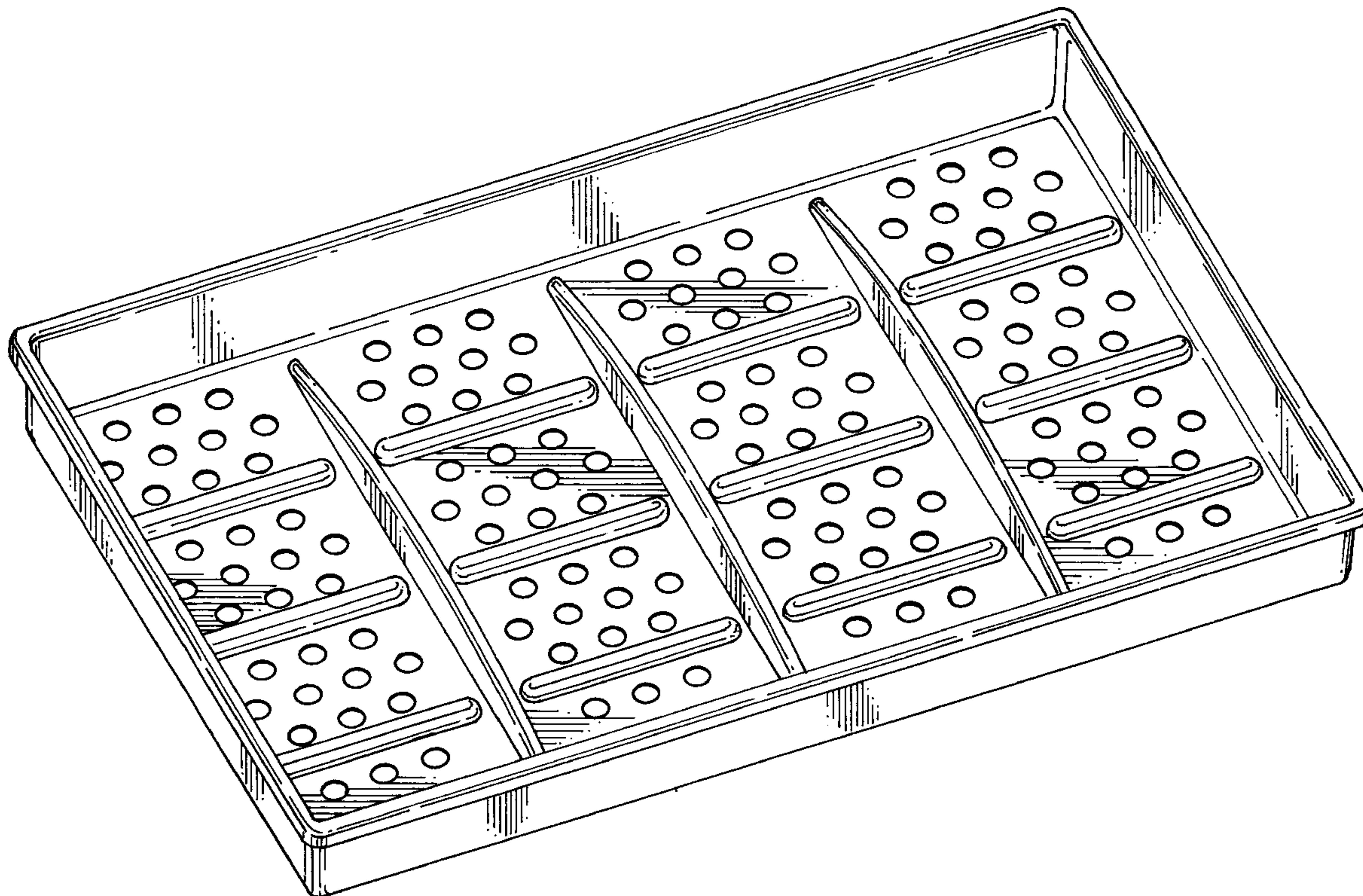

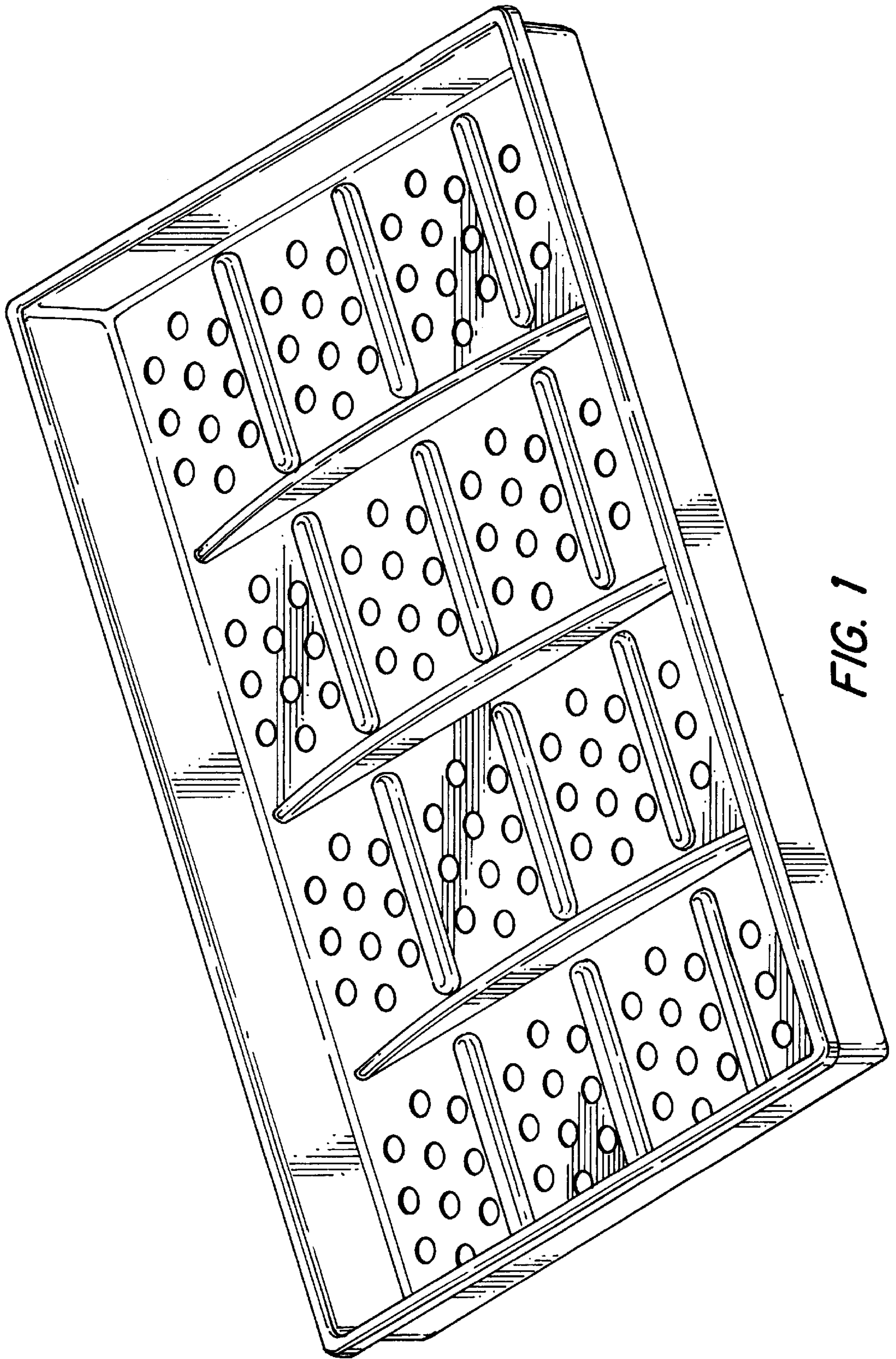

FIG. 1

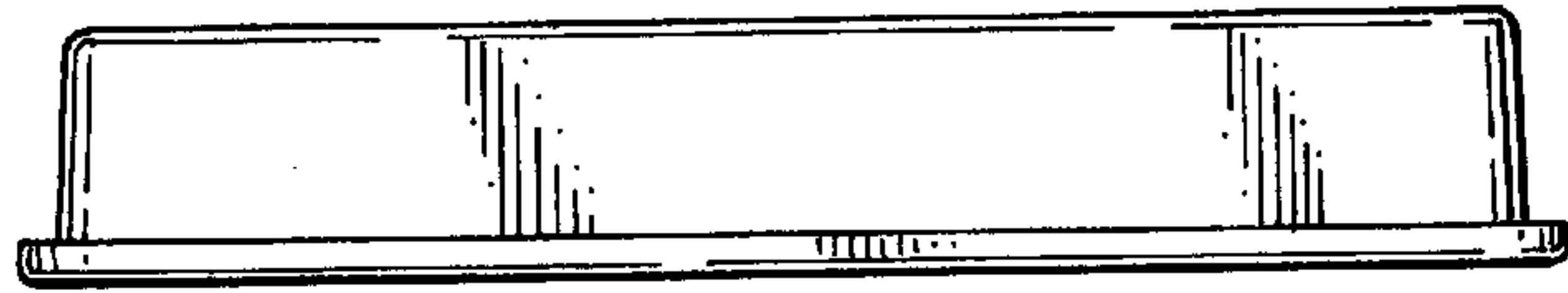

FIG. 3

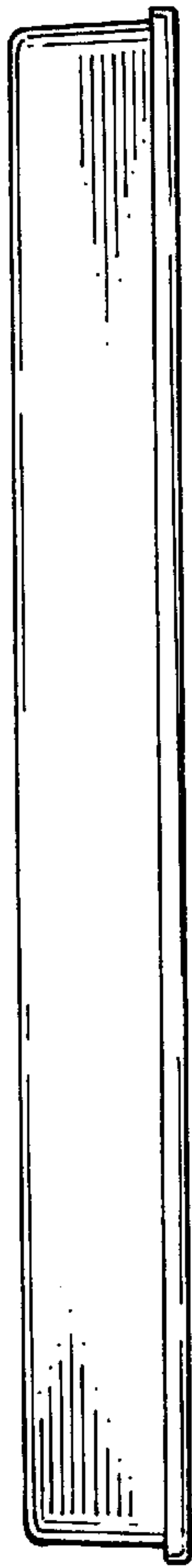

FIG. 6

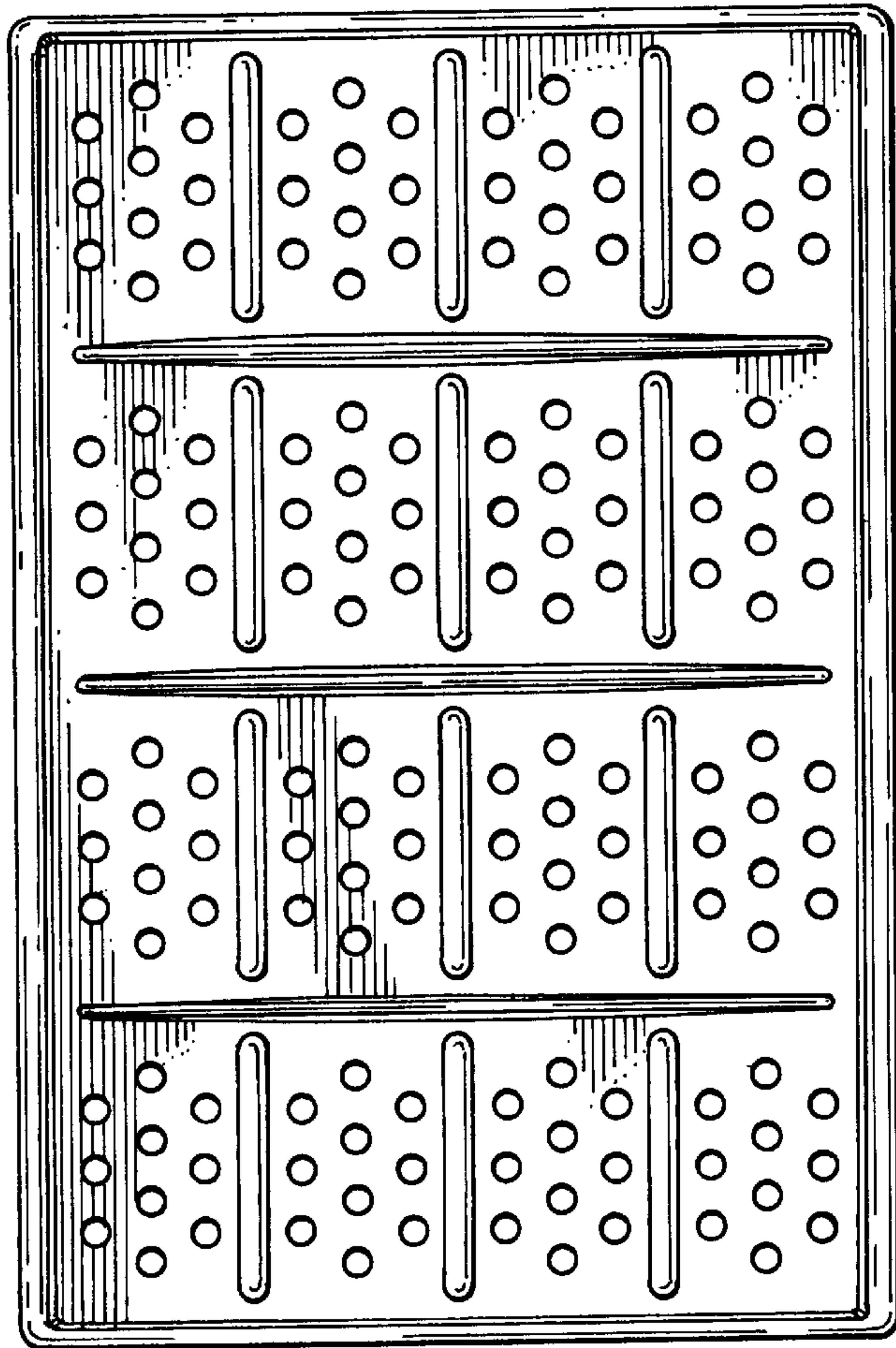

FIG. 2

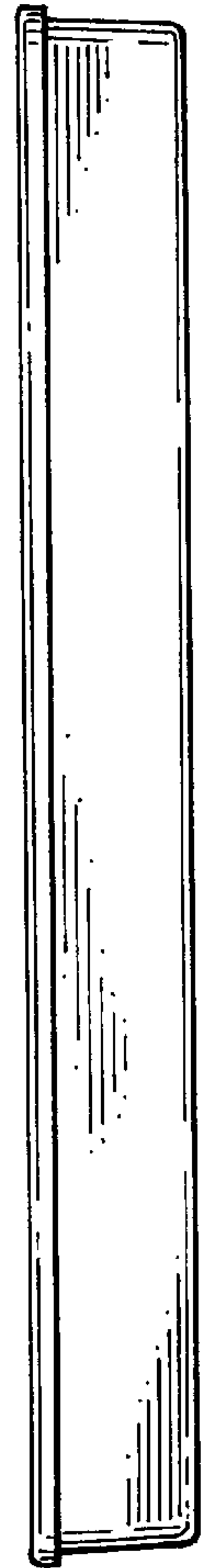

FIG. 4

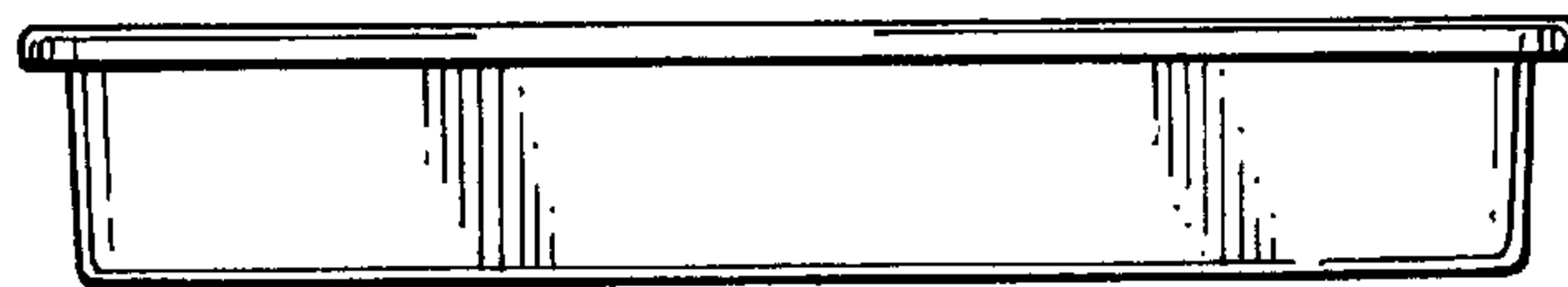

FIG. 5

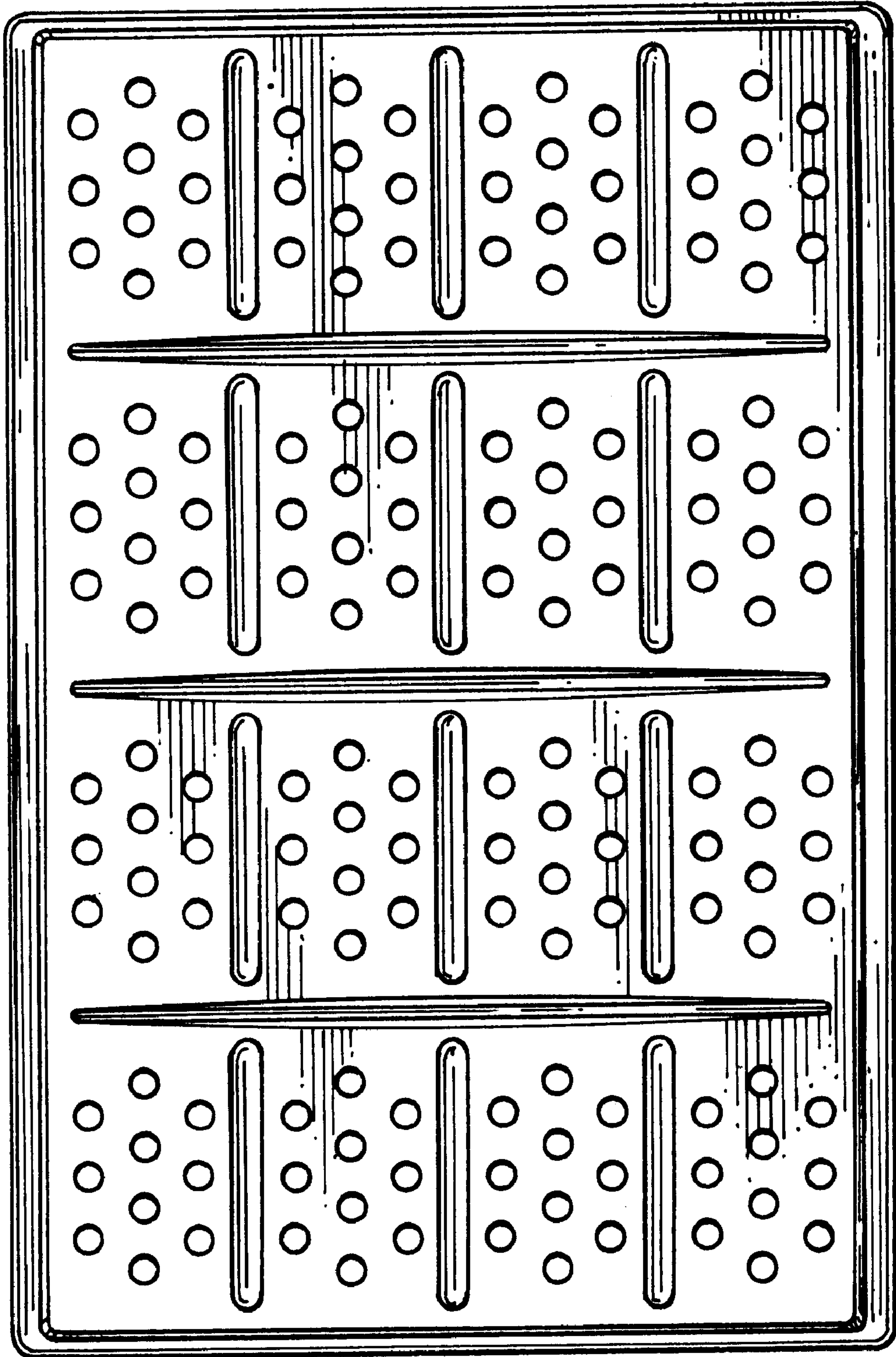

FIG. 7