



US00D414413S

United States Patent [19]
Brown

[11] **Patent Number: Des. 414,413**
[45] **Date of Patent: ** Sep. 28, 1999**

[54] **CONTAINER**

[76] Inventor: **Dean Brown**, 200 E. Greenwood Ave.,
La Habra, Calif. 90631

[**] Term: **14 Years**

[21] Appl. No.: **29/087,582**

[22] Filed: **May 6, 1998**

[51] **LOC (6) Cl.** **09-07**

[52] **U.S. Cl.** **D9/429; D9/425**

[58] **Field of Search** D9/424, 425, 428,
D9/429, 430, 513; D7/601, 608, 640; 206/508,
503, 515; 220/662, 669, 674, 675, 657,
659, 556, 4.25

[56] **References Cited**

U.S. PATENT DOCUMENTS

D. 131,150	1/1942	Swofford .	
D. 194,434	1/1963	Whitman .	
D. 256,682	9/1980	Lee et al.	D9/429 X
D. 264,686	6/1982	Davis	D9/429
D. 342,447	12/1993	Aylward	D9/429
D. 375,683	11/1996	Schoff	D9/429
D. 381,563	7/1997	Longstreth .	
D. 392,159	3/1998	Longstreth .	
D. 395,822	7/1998	Keal et al.	D9/429
528,072	10/1894	Bukenhofer et al. .	
933,881	9/1909	Brown .	
1,507,685	9/1924	Robinson .	
1,696,098	12/1928	McGranighan .	
1,974,898	9/1934	Rutledge .	
2,170,040	8/1939	Stuart .	
2,179,188	11/1939	Kitselman .	
2,283,704	5/1942	Staudal .	
2,811,152	10/1957	Wicks .	
3,037,677	6/1962	Debs .	
3,474,929	10/1969	Harker .	
3,598,278	8/1971	Vann .	
3,625,305	12/1971	Mueller .	
3,737,068	6/1973	Bird .	

(List continued on next page.)

FOREIGN PATENT DOCUMENTS

WO 98/32665 7/1998 WIPO .

OTHER PUBLICATIONS

Ultra Fresh Bakery Containers, p. 10, Mar. 1995.
International Search Report, International Application No.
PCT/US98/00908, International Filing Date Jan. 23, 1998.

Primary Examiner—Prabhakar Deshmukh

[57] **CLAIM**

The ornamental design for container, as shown and described.

DESCRIPTION

FIG. 1 is a left side perspective view of the container of my new design;
 FIG. 2 is a right side elevational view thereof, the left side elevational view being a mirror image thereof;
 FIG. 3 is a top plan view thereof;
 FIG. 4 is a bottom plan view thereof;
 FIG. 5 is a rear elevational view thereof;
 FIG. 6 is a front elevational view thereof;
 FIG. 7 is a left side perspective view of a second embodiment thereof;
 FIG. 8 is a right side elevational view thereof, the left side elevational view being a mirror image thereof;
 FIG. 9 is a top plan view thereof;
 FIG. 10 is a bottom plan view thereof;
 FIG. 11 is a front elevational view thereof;
 FIG. 12 is a rear elevational view thereof;
 FIG. 13 is a left side perspective view of a third alternative embodiment thereof;
 FIG. 14 is a right side elevational view thereof, the left side elevational view being a mirror image thereof;
 FIG. 15 is a top plan view thereof;
 FIG. 16 is a bottom plan view thereof;
 FIG. 17 is a rear elevational view thereof; and,
 FIG. 18 is a front elevational view thereof.

1 Claim, 18 Drawing Sheets

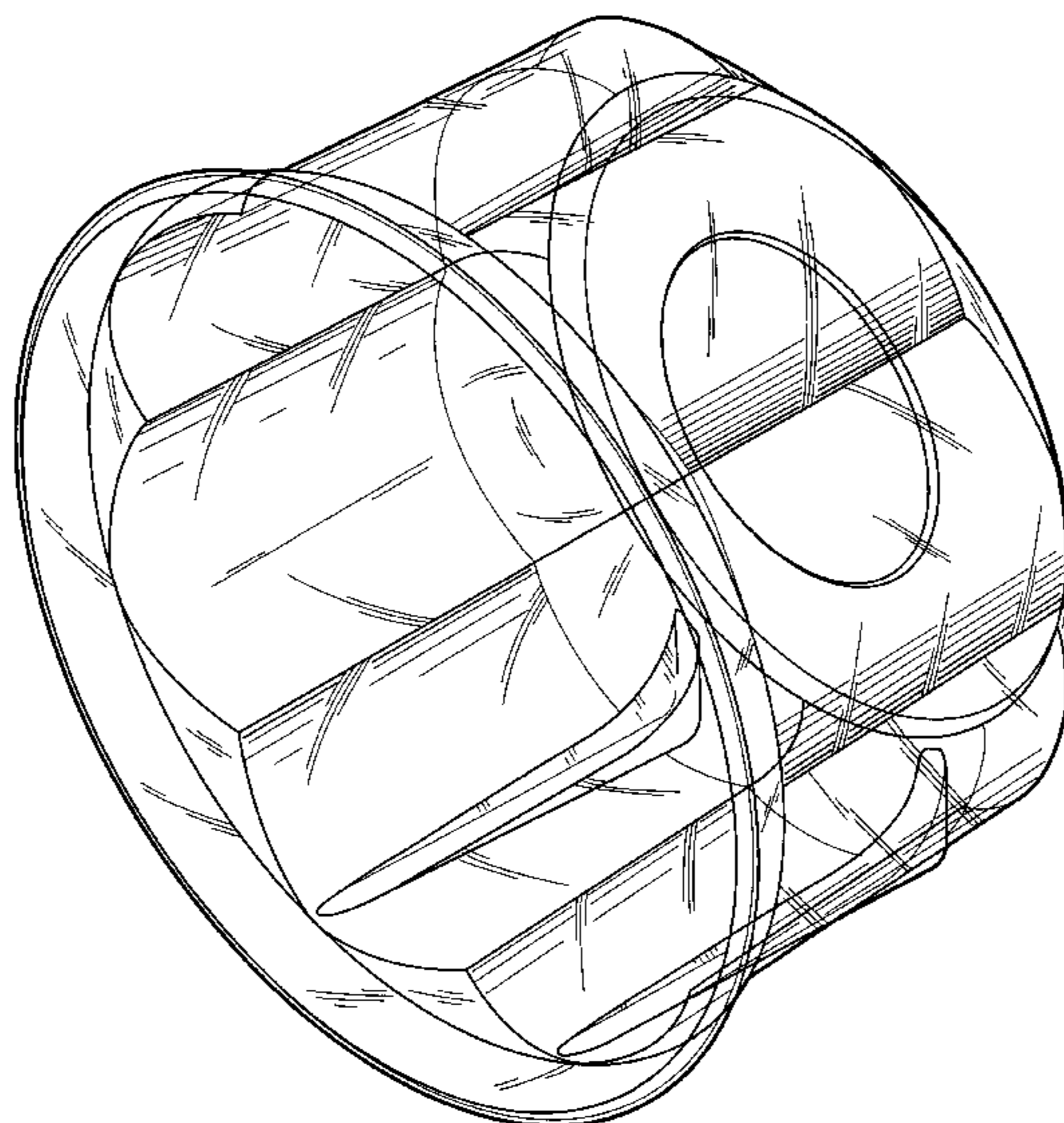

Des. 414,413

Page 2

U.S. PATENT DOCUMENTS

3,918,629	11/1975	Forbes, Jr. et al.	229/4.5	X	4,962,849	10/1990	Anderson .	
4,157,762	6/1979	Robinson .			5,011,006	4/1991	Anderson .	
4,197,940	4/1980	DeRossett .			5,169,023	12/1992	Heiberg et al. .	
4,202,464	5/1980	Mohs et al. .			5,375,701	12/1994	Hustad et al. .	
4,705,163	11/1987	James .			5,390,816	2/1995	Boyd .	
4,863,058	9/1989	Antoni et al.	220/675		5,542,565	8/1996	Hidalgo-Lopez .	
4,874,083	10/1989	Antoni et al. .			5,657,873	8/1997	Hustad et al. .	
4,901,858	2/1990	Anderson .			5,657,874	8/1997	Hustad et al. .	
4,909,392	3/1990	Williams et al. .			5,685,453	11/1997	Goins et al.	220/675 X
4,930,627	6/1990	Borst et al. .			5,695,798	12/1997	Rozzano .	
4,961,494	10/1990	Alexander .			5,782,376	7/1998	Brauner et al.	220/675 X

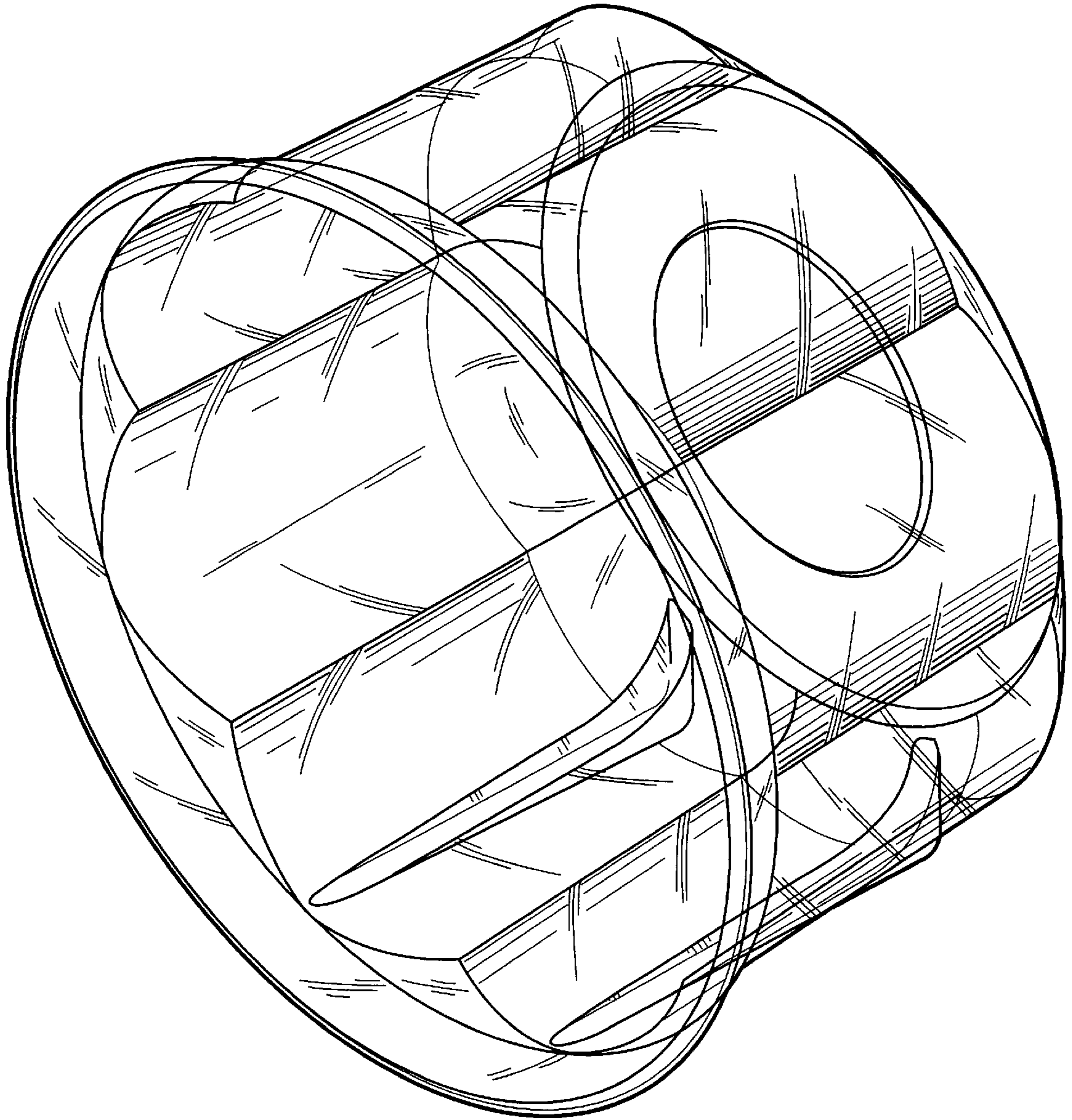

FIG. 1

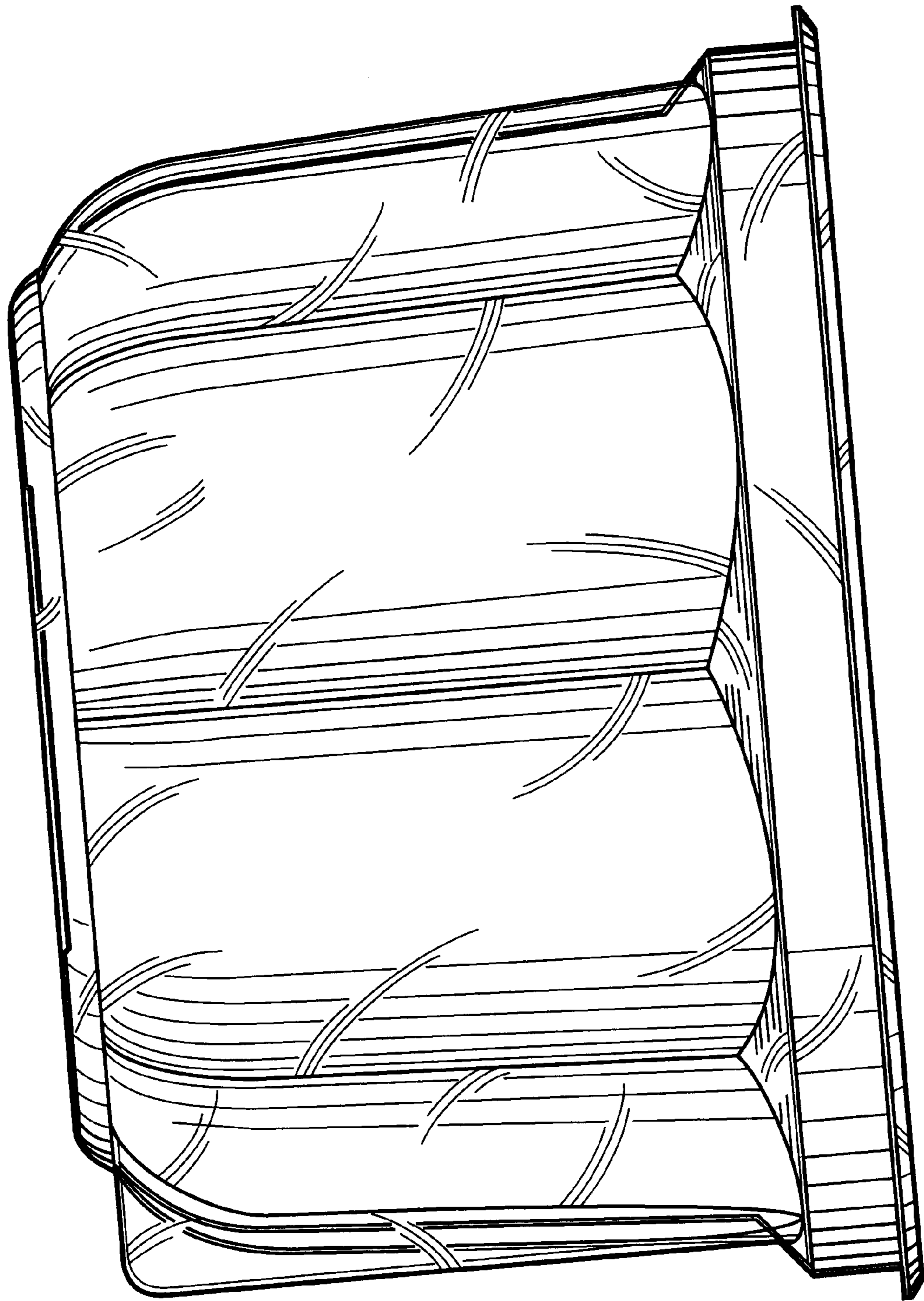

FIG. 2

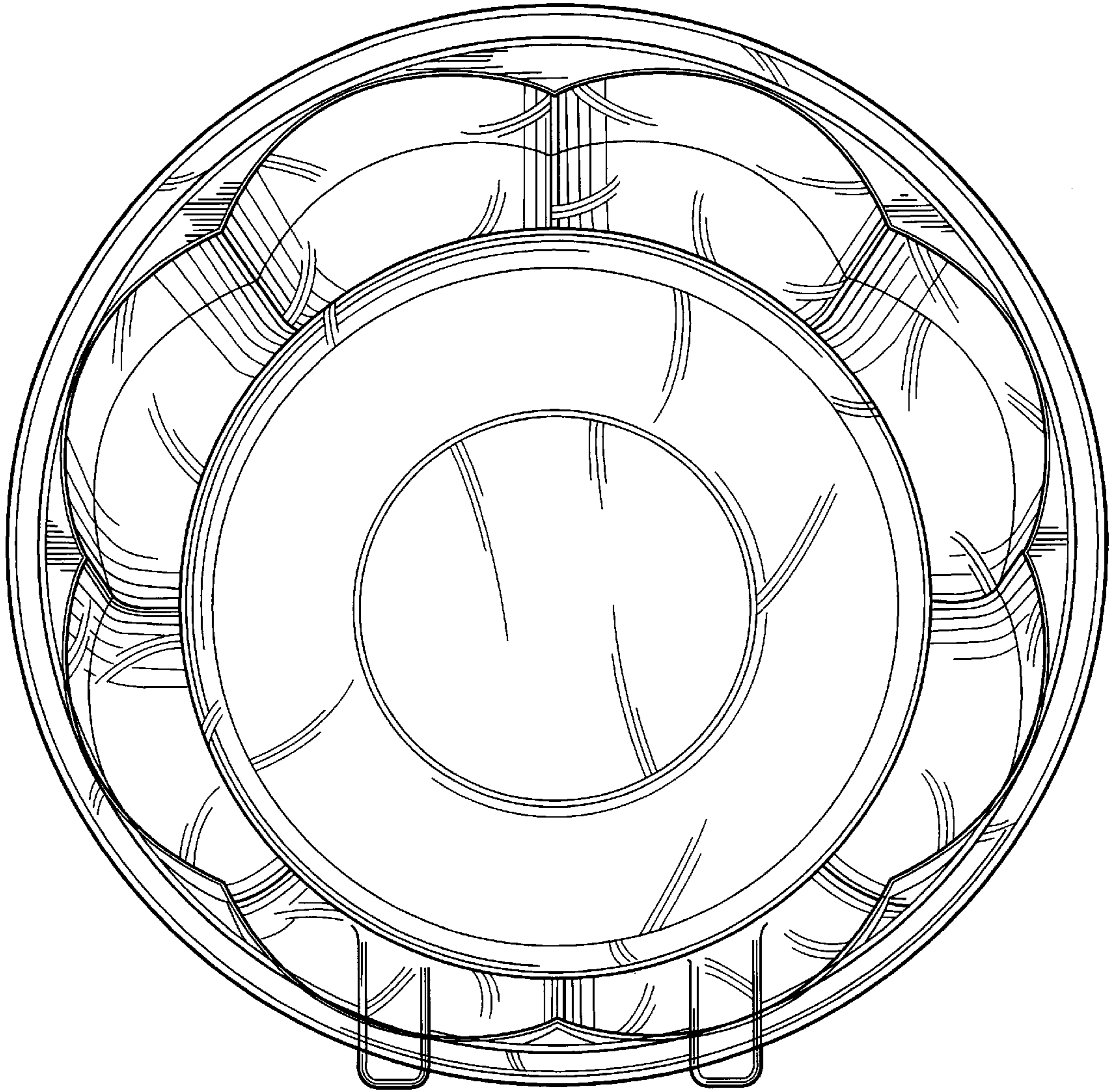

FIG. 3

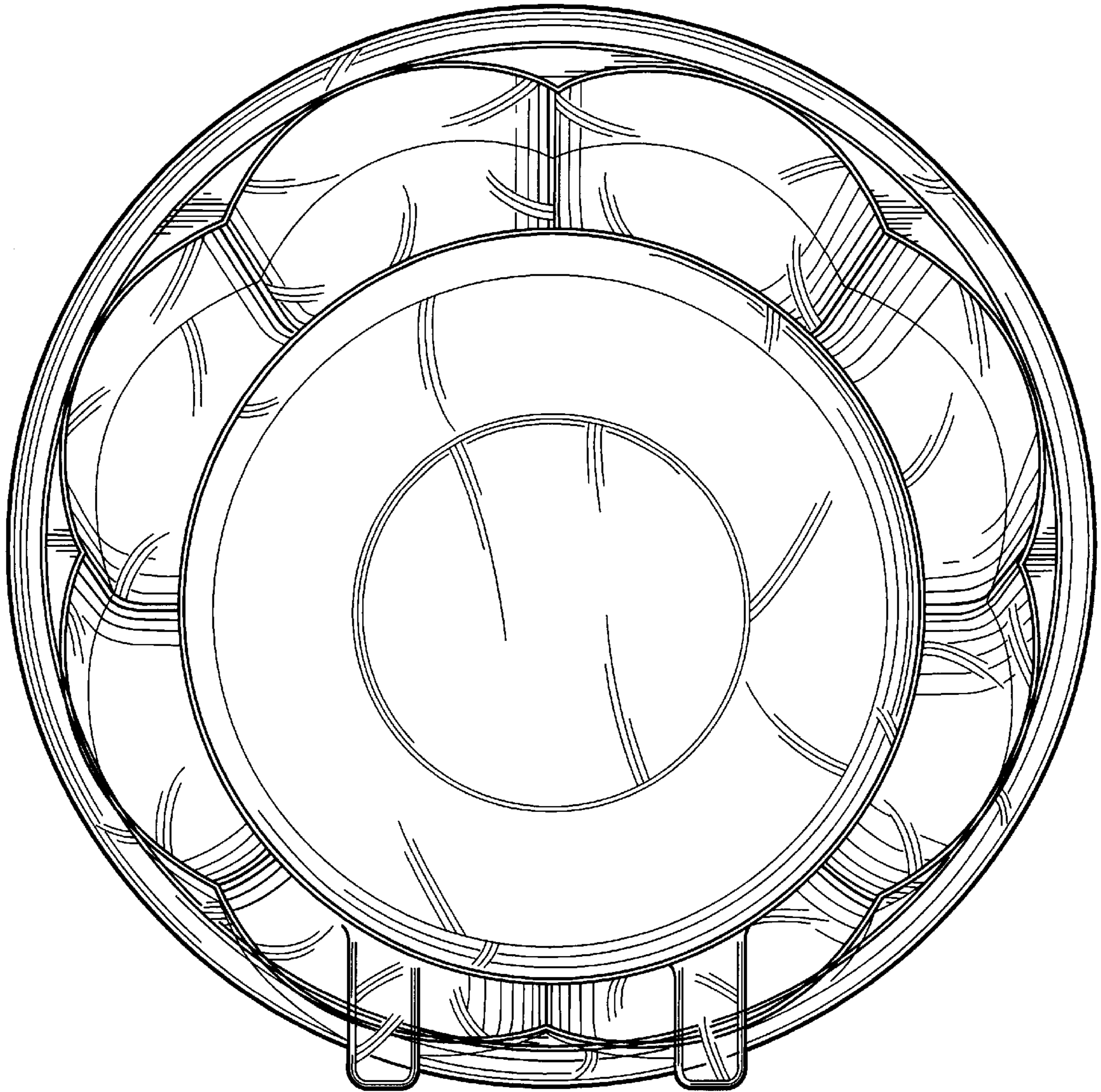

FIG. 4

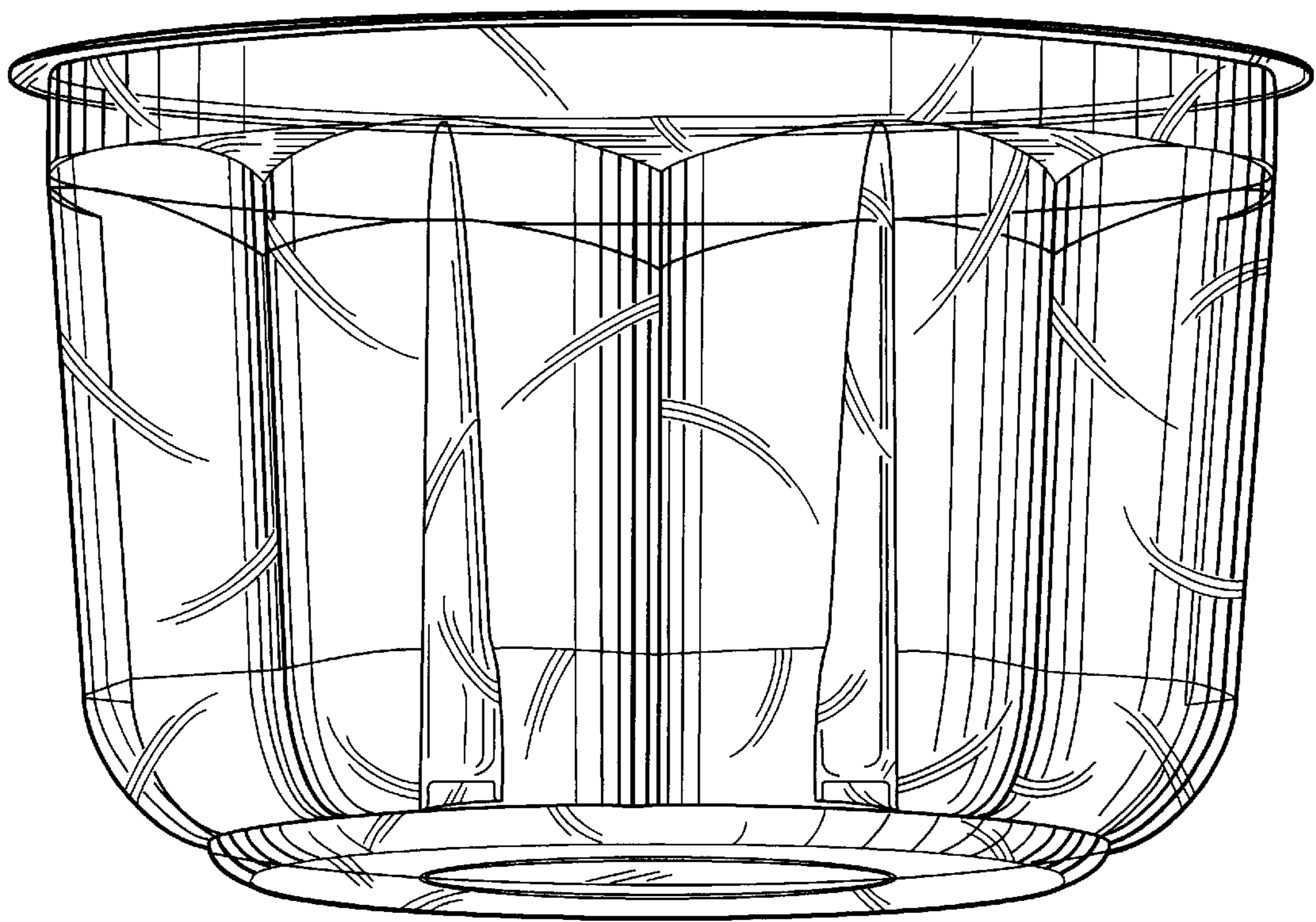

FIG. 5

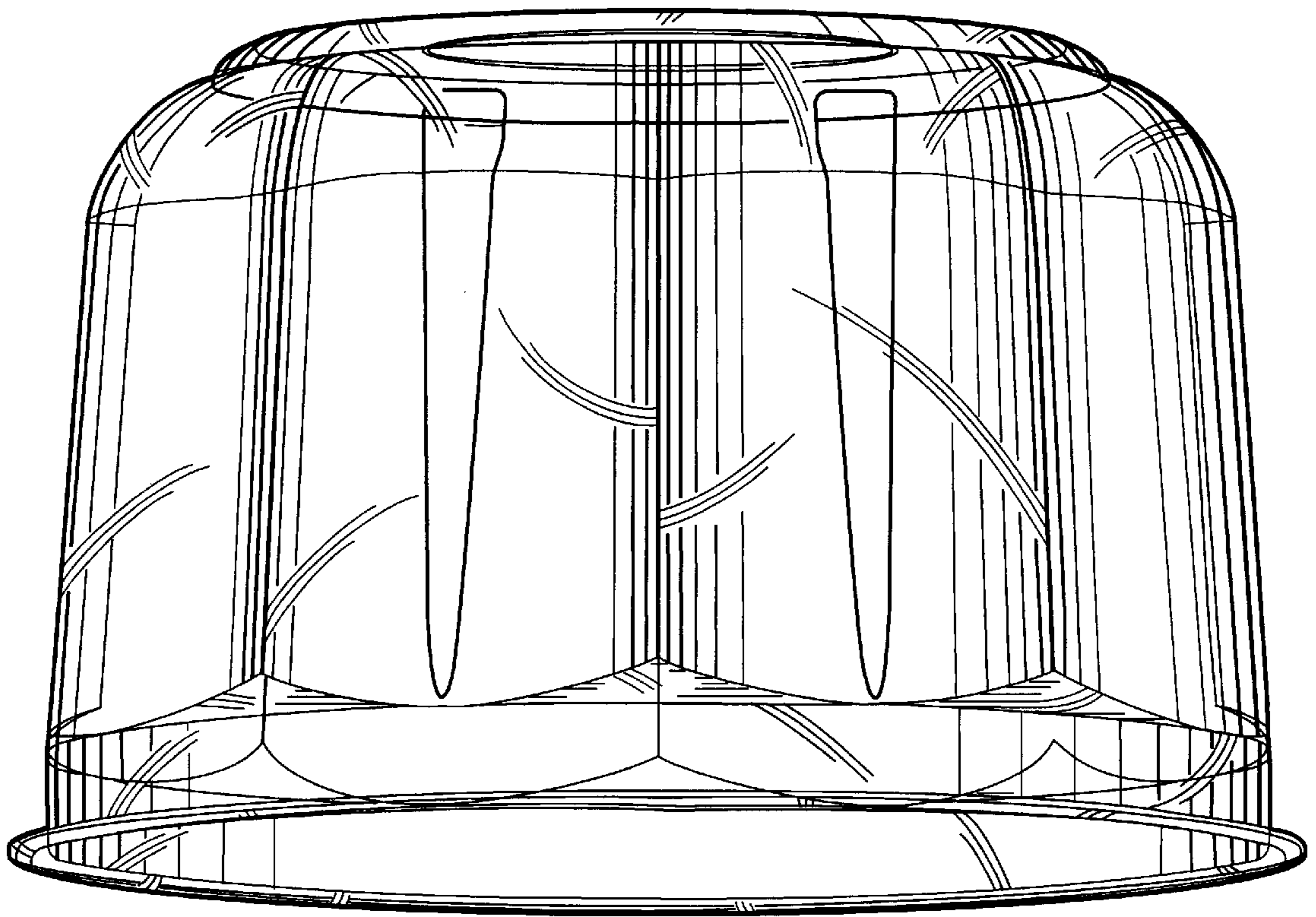

FIG. 6

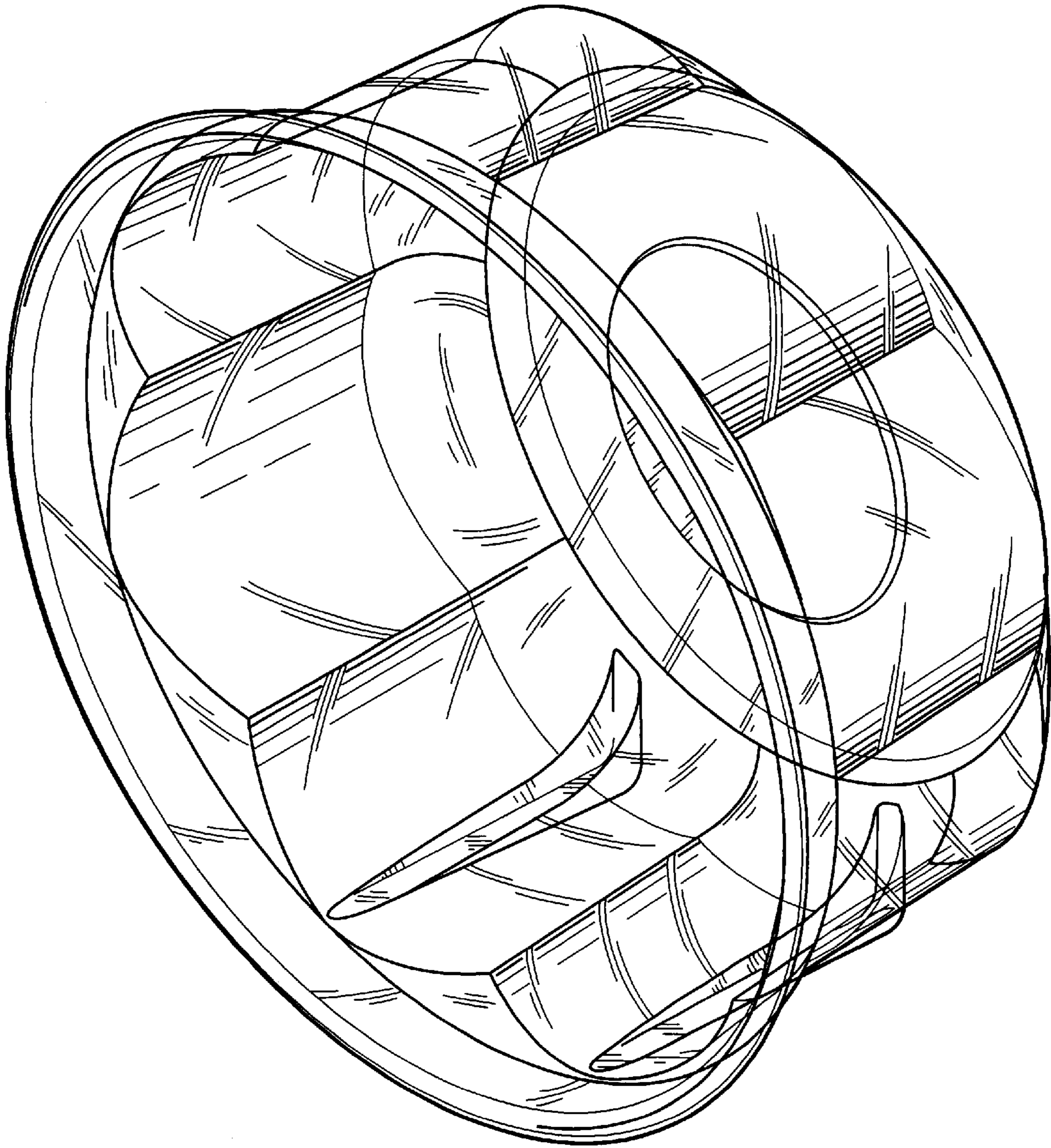

FIG. 7

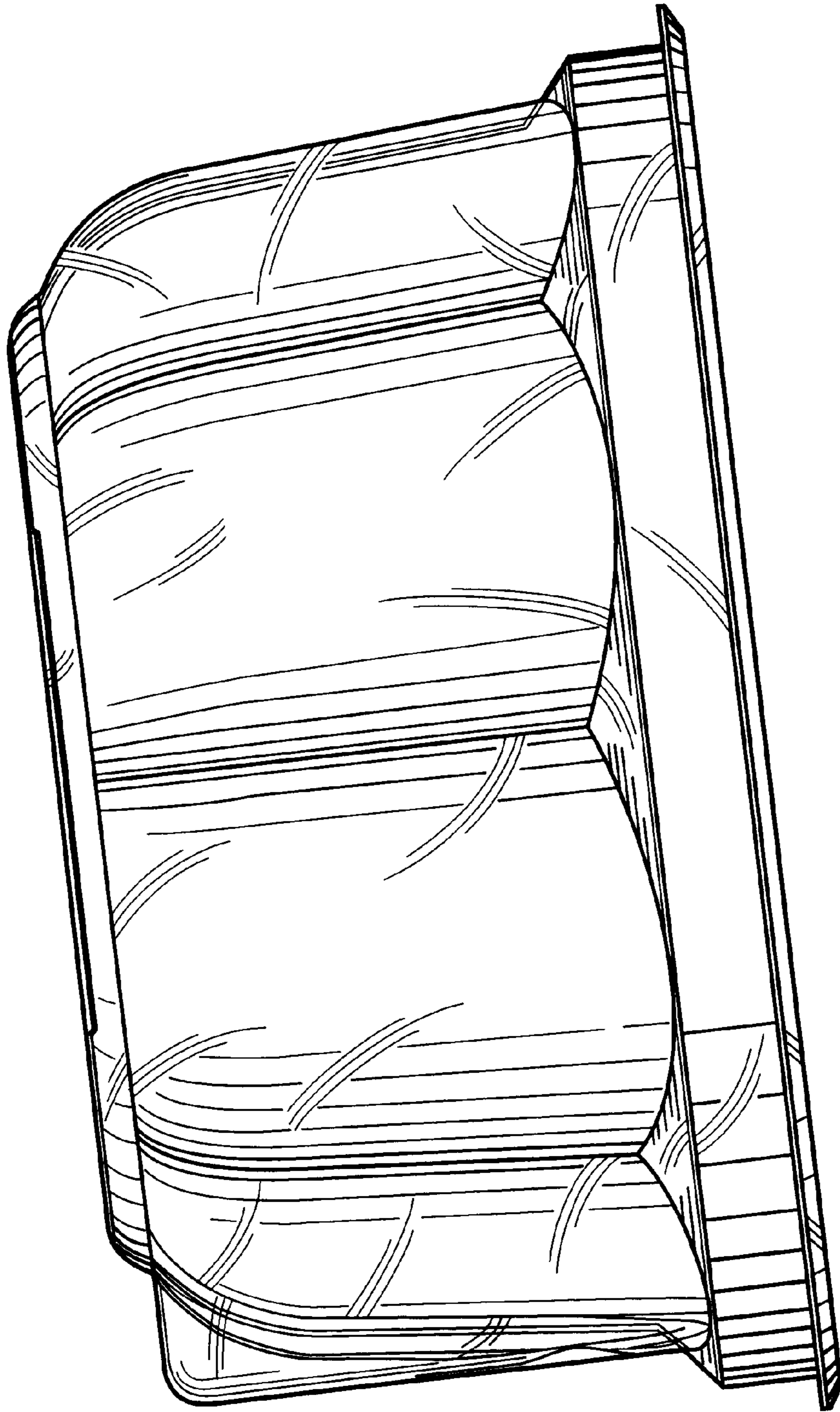

FIG. 8

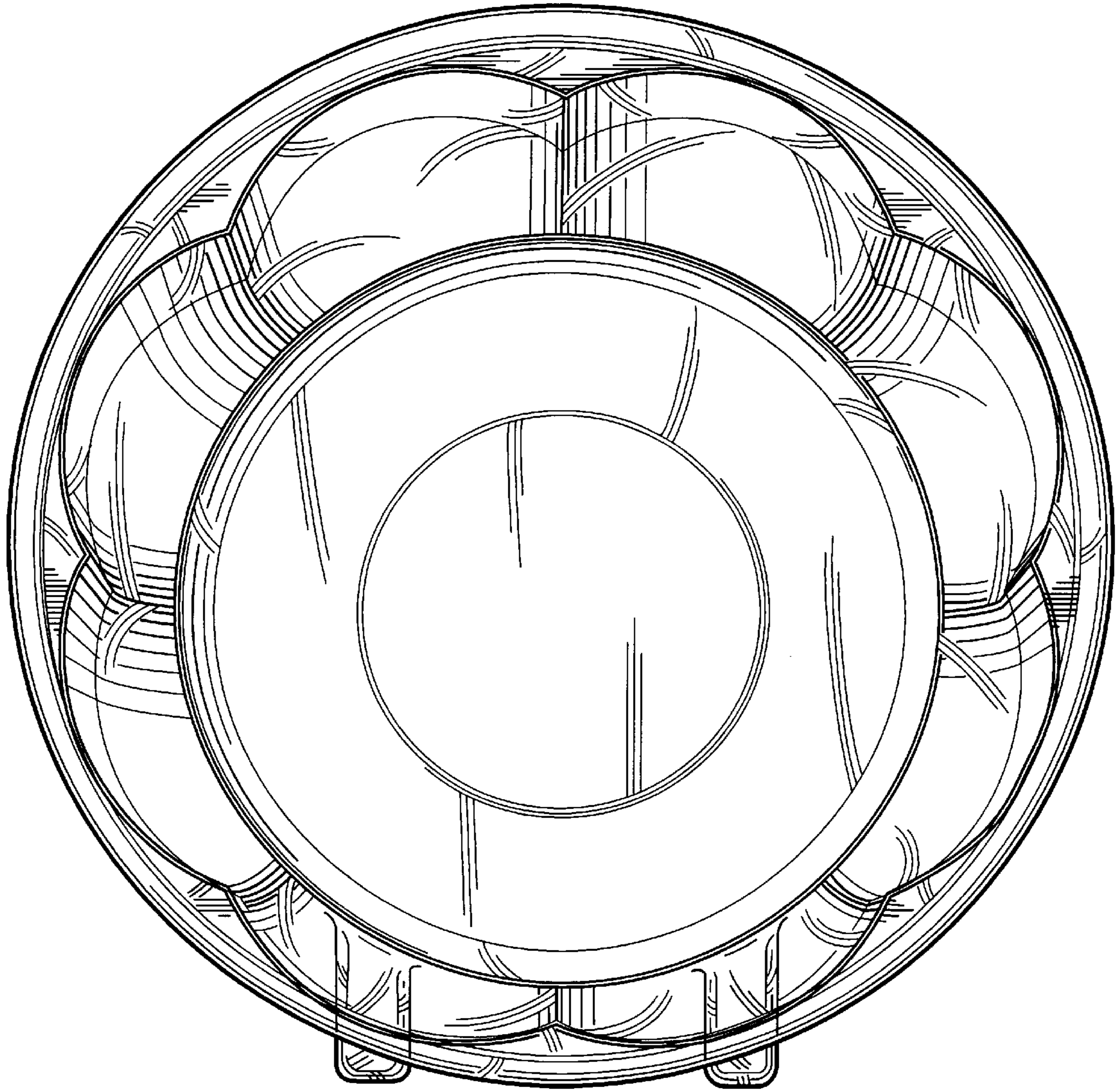

FIG. 9

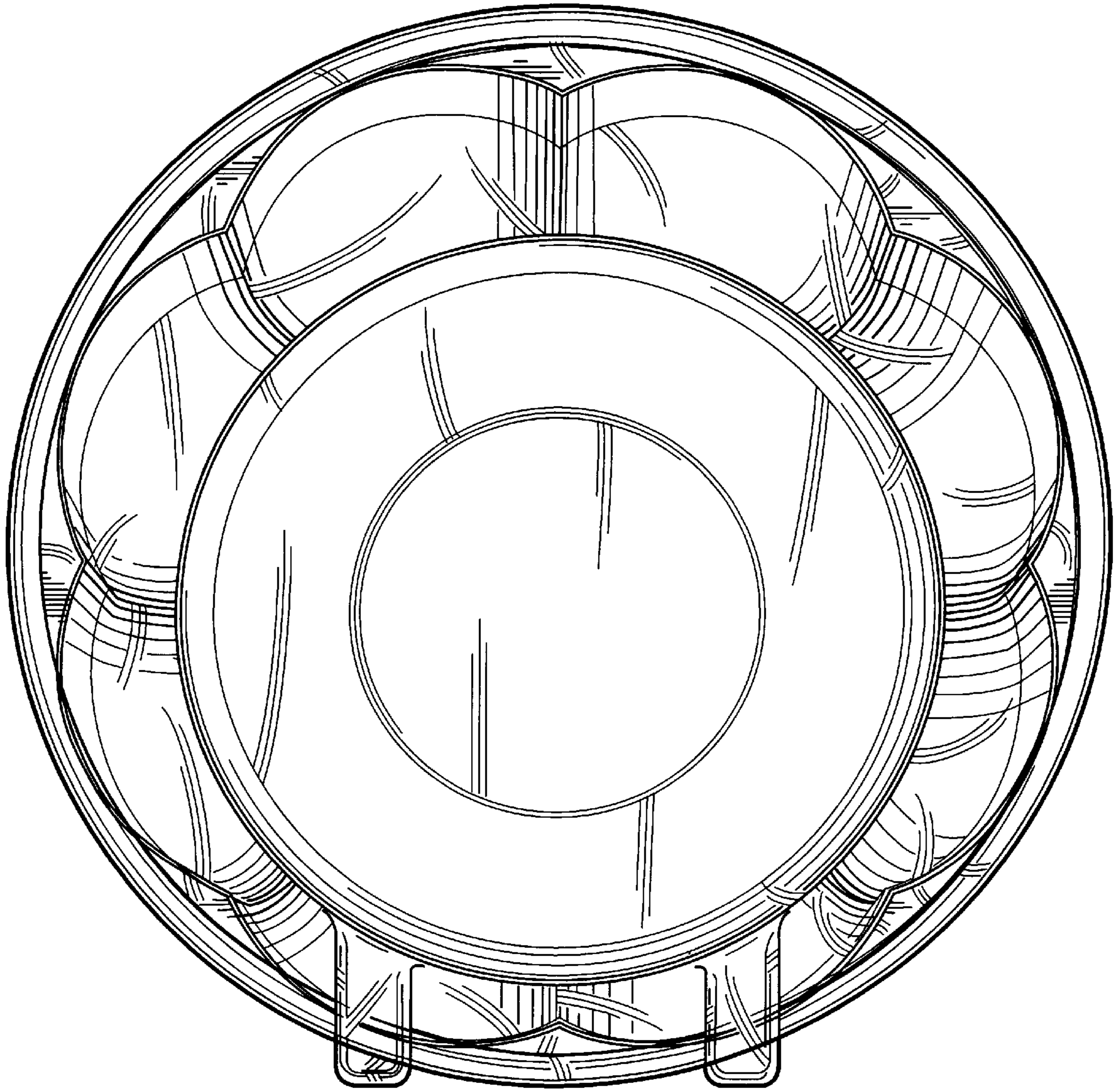

FIG. 10

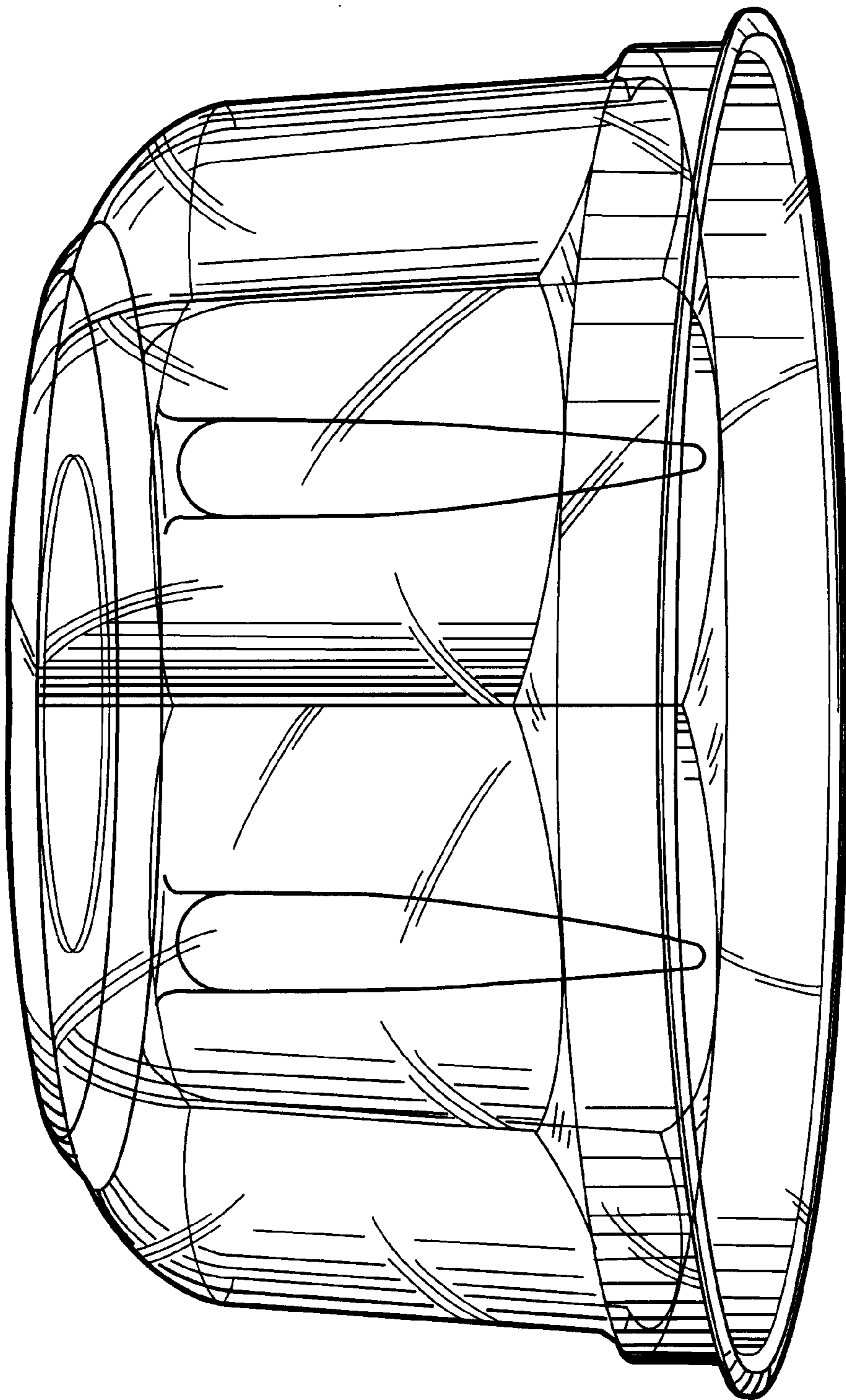

FIG. 11

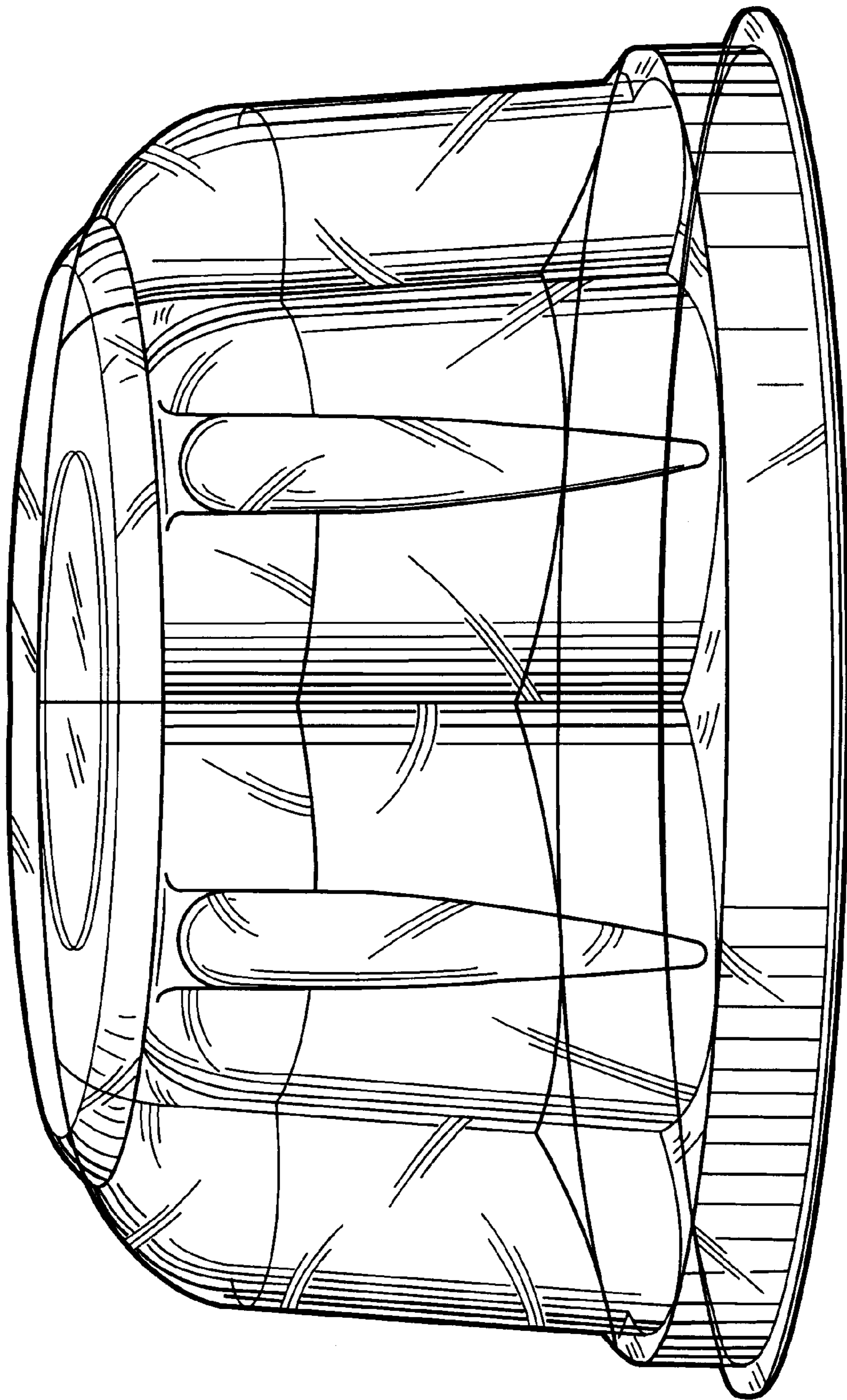

FIG. 12

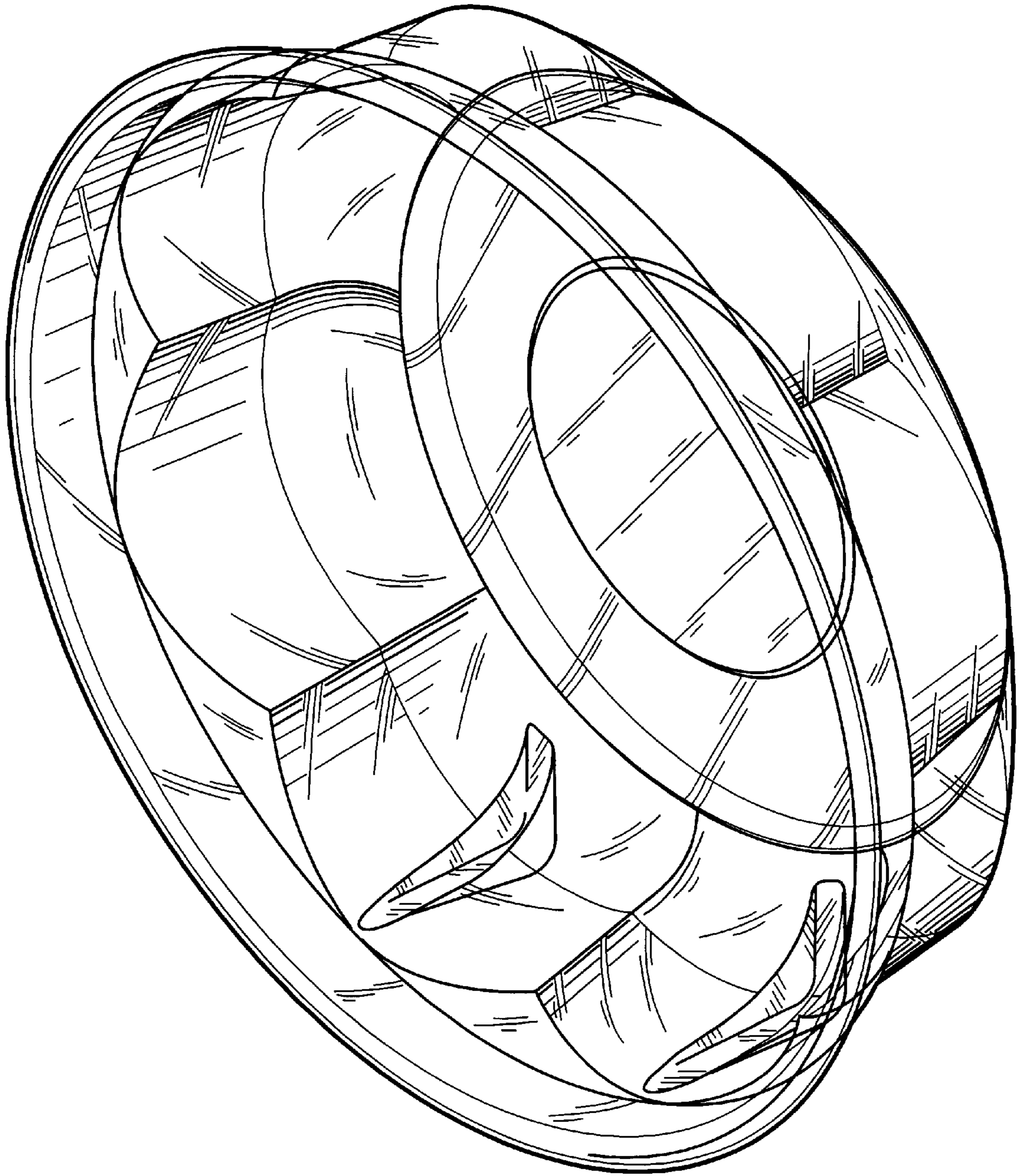

FIG. 13

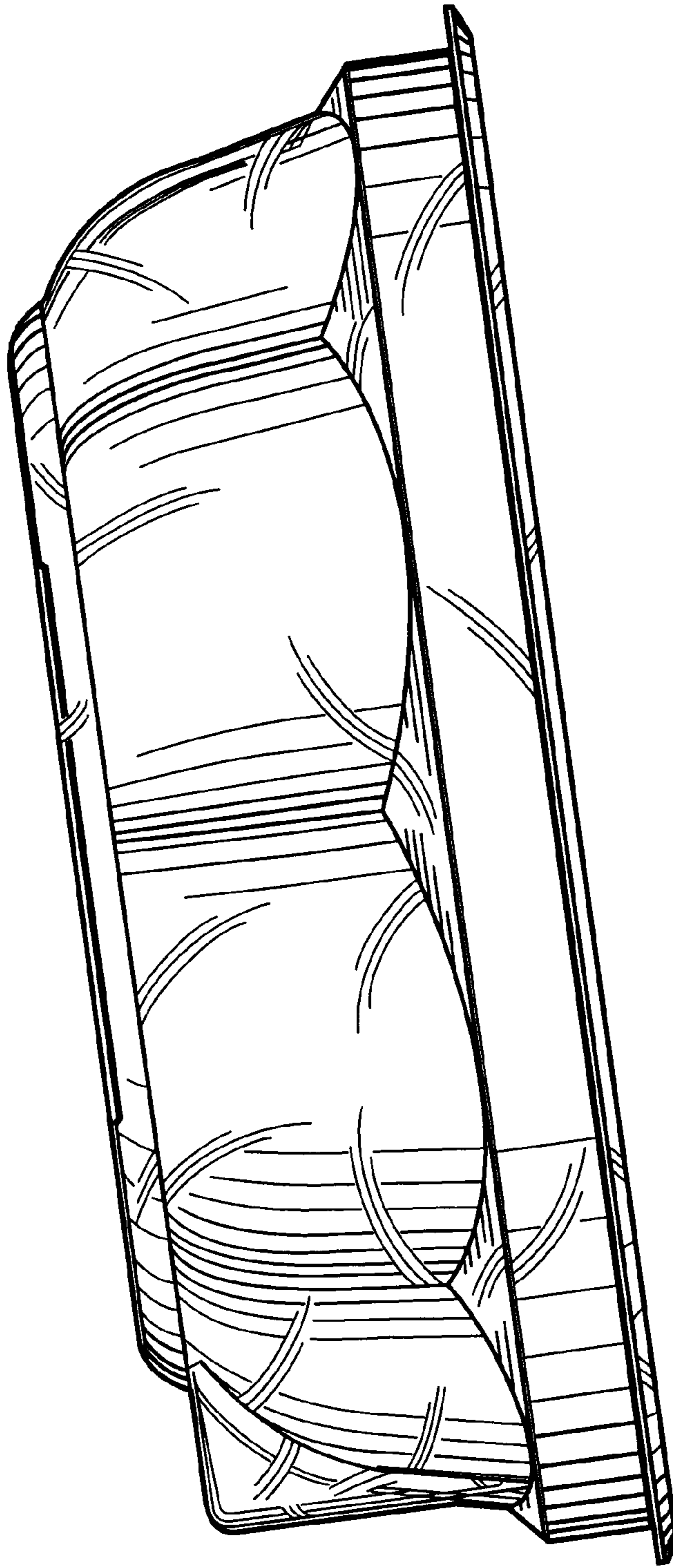

FIG. 14

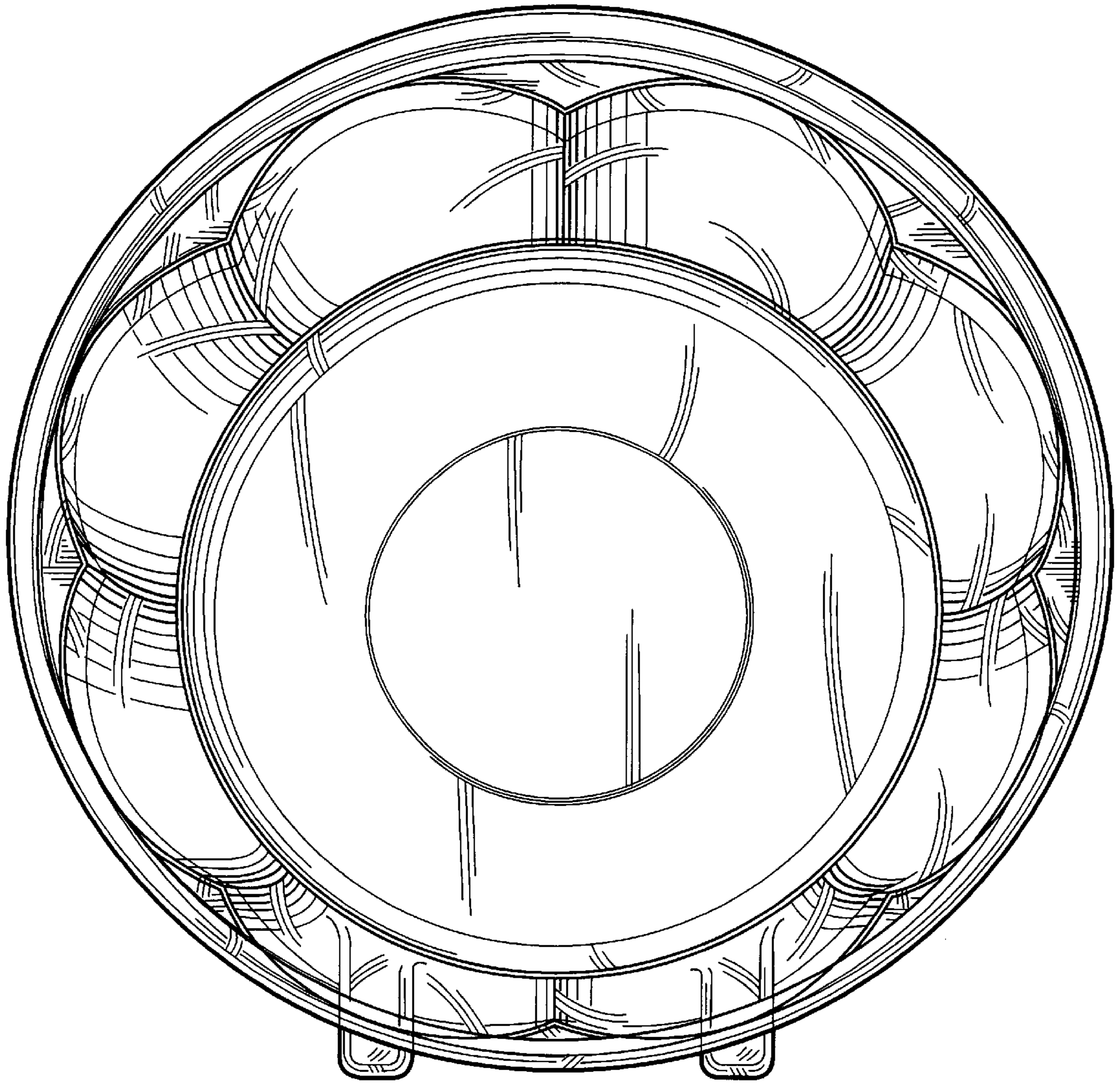

FIG. 15

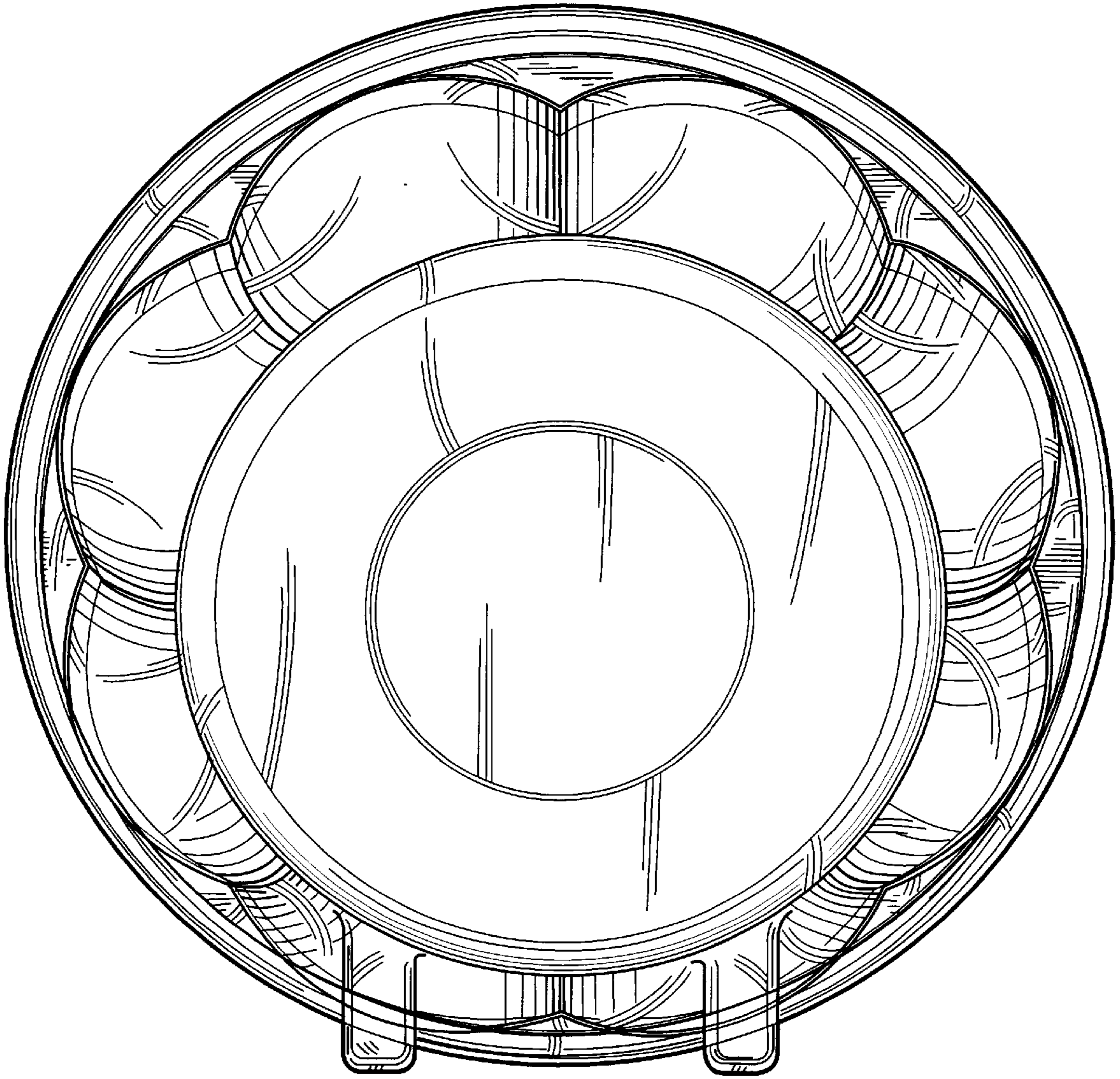

FIG. 16

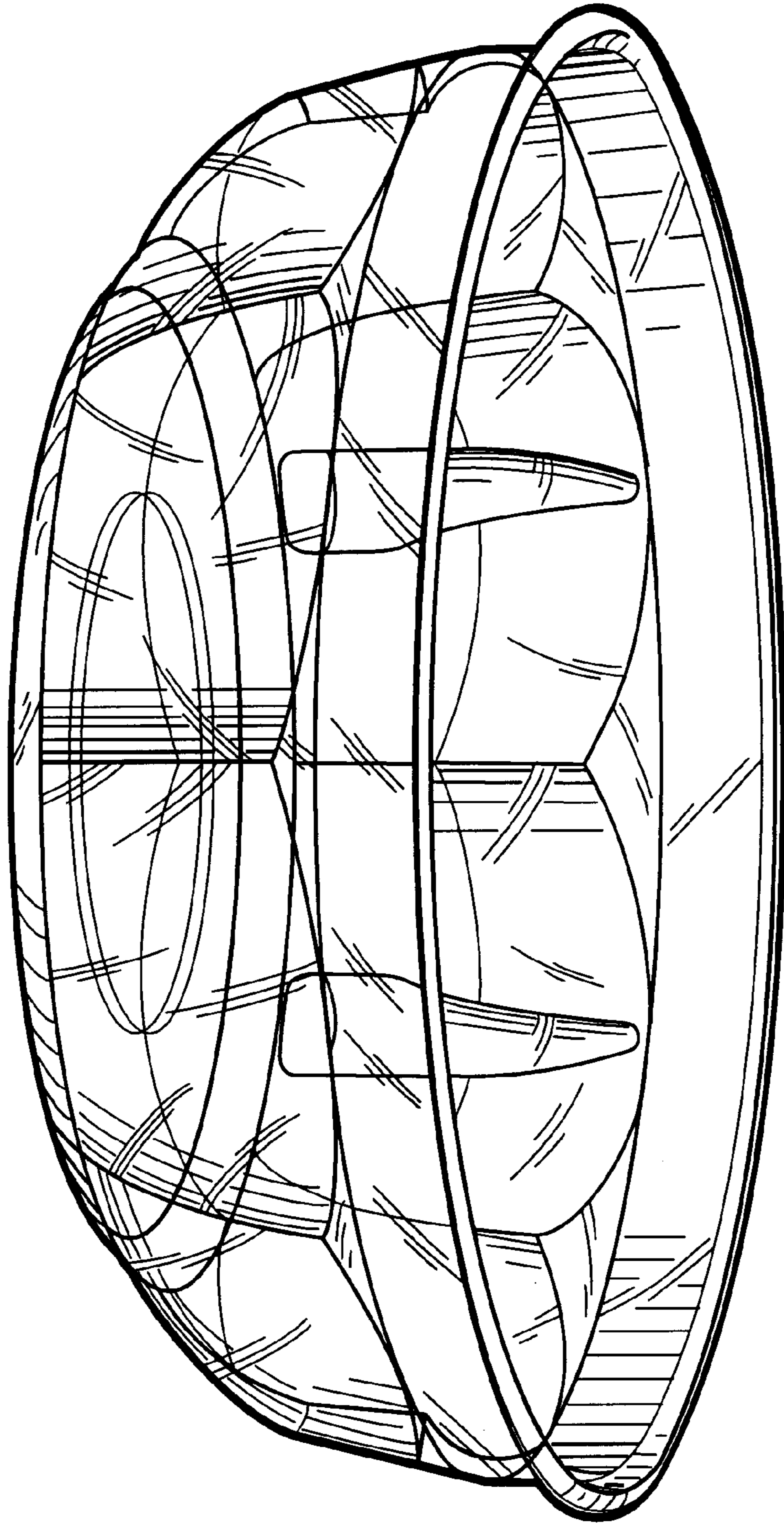

FIG. 17

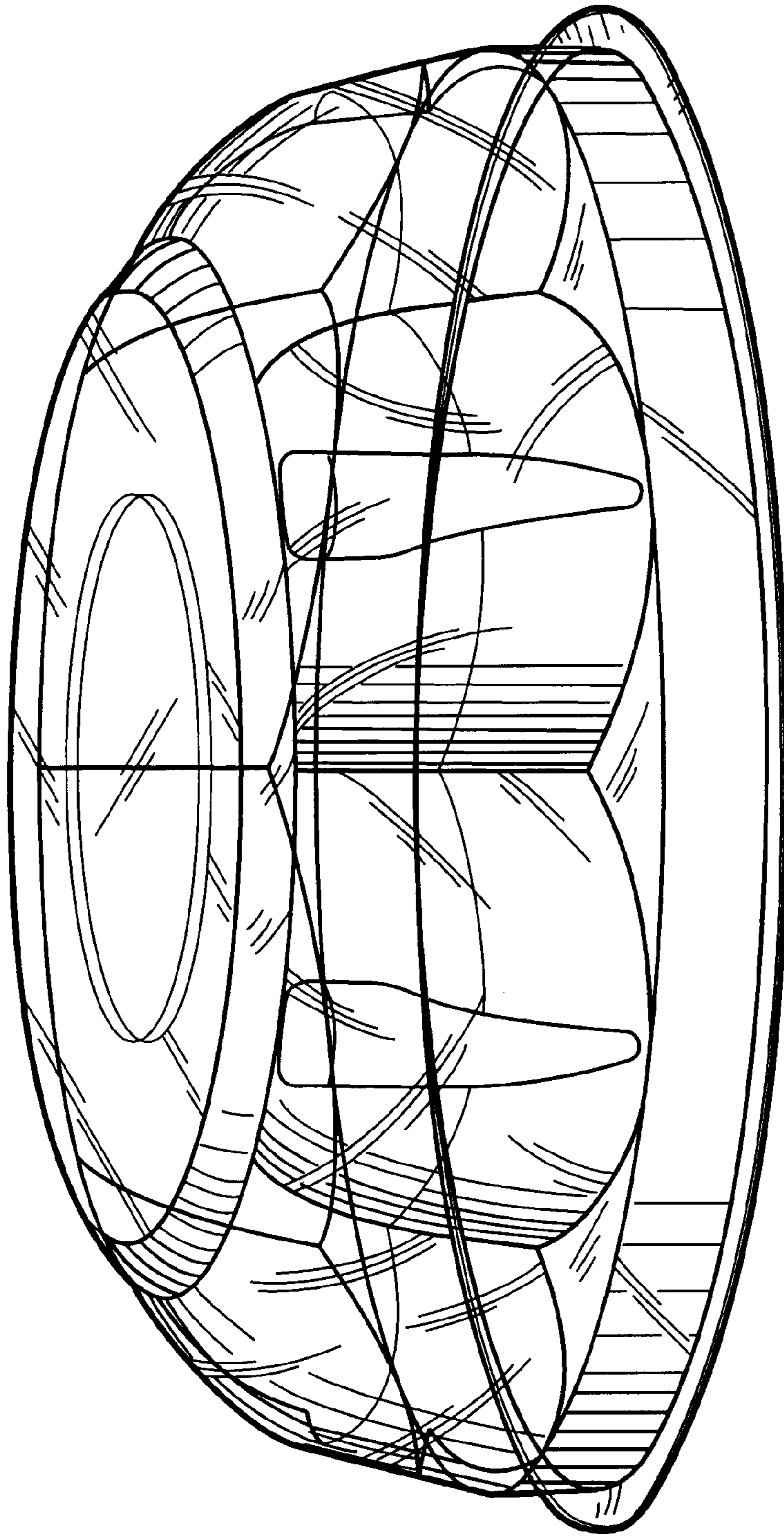

FIG. 18