



US00D414399S

United States Patent [19]
Nakamura

[11] **Patent Number: Des. 414,399**

[45] **Date of Patent: ** Sep. 28, 1999**

[54] **WIRE BUNDLE SUPPORT**

[75] Inventor: **Toshinobu Nakamura**, Tokyo, Japan

[73] Assignee: **Shinagawa Shoko Co., Ltd.**, Tokyo, Japan

[**] Term: **14 Years**

[21] Appl. No.: **29/083,527**

[22] Filed: **Feb. 11, 1998**

[30] **Foreign Application Priority Data**

Sep. 16, 1997 [JP] Japan 9-67509

[51] **LOC (6) Cl.** **08-05**

[52] **U.S. Cl.** **D8/356**

[58] **Field of Search** D8/356, 394, 396;
248/68.1, 74.1-74.4

[56] **References Cited**

U.S. PATENT DOCUMENTS

D. 272,762	2/1984	Sakaguchi	D8/394	X
D. 272,763	2/1984	Sakaguchi	D8/394	X
D. 317,558	6/1991	Daigle et al.	D8/356	X
4,609,171	9/1986	Matsui	248/49	X

Primary Examiner—Holly Baynham

Attorney, Agent, or Firm—Frishauf, Holtz, Goodman, Langer & Chick

[57] **CLAIM**

The ornamental design for a wire bundle support, as shown and described.

DESCRIPTION

FIG. 1 is a front, top and left side perspective view of a wire bundle support, showing my new design;
 FIG. 2 is a front elevational view thereof;
 FIG. 3 is a rear elevational view thereof;
 FIG. 4 is a top plan view thereof;
 FIG. 5 is a bottom plan view thereof;
 FIG. 6 is a left side view thereof;
 FIG. 7 is a right side view thereof;
 FIG. 8 is a front, top and left side perspective view thereof showing a state when a lever thereof is locked;
 FIG. 9 is a front view showing the state when the lever is locked;
 FIG. 10 is a rear view showing the state when the lever is locked;
 FIG. 11 is a top plan view showing the state when the lever is locked;
 FIG. 12 is a bottom plan view showing the state when the lever is locked;
 FIG. 13 is a left side view showing the state when the lever is locked; and,
 FIG. 14 is a right side view showing the state when the lever is locked.

1 Claim, 8 Drawing Sheets

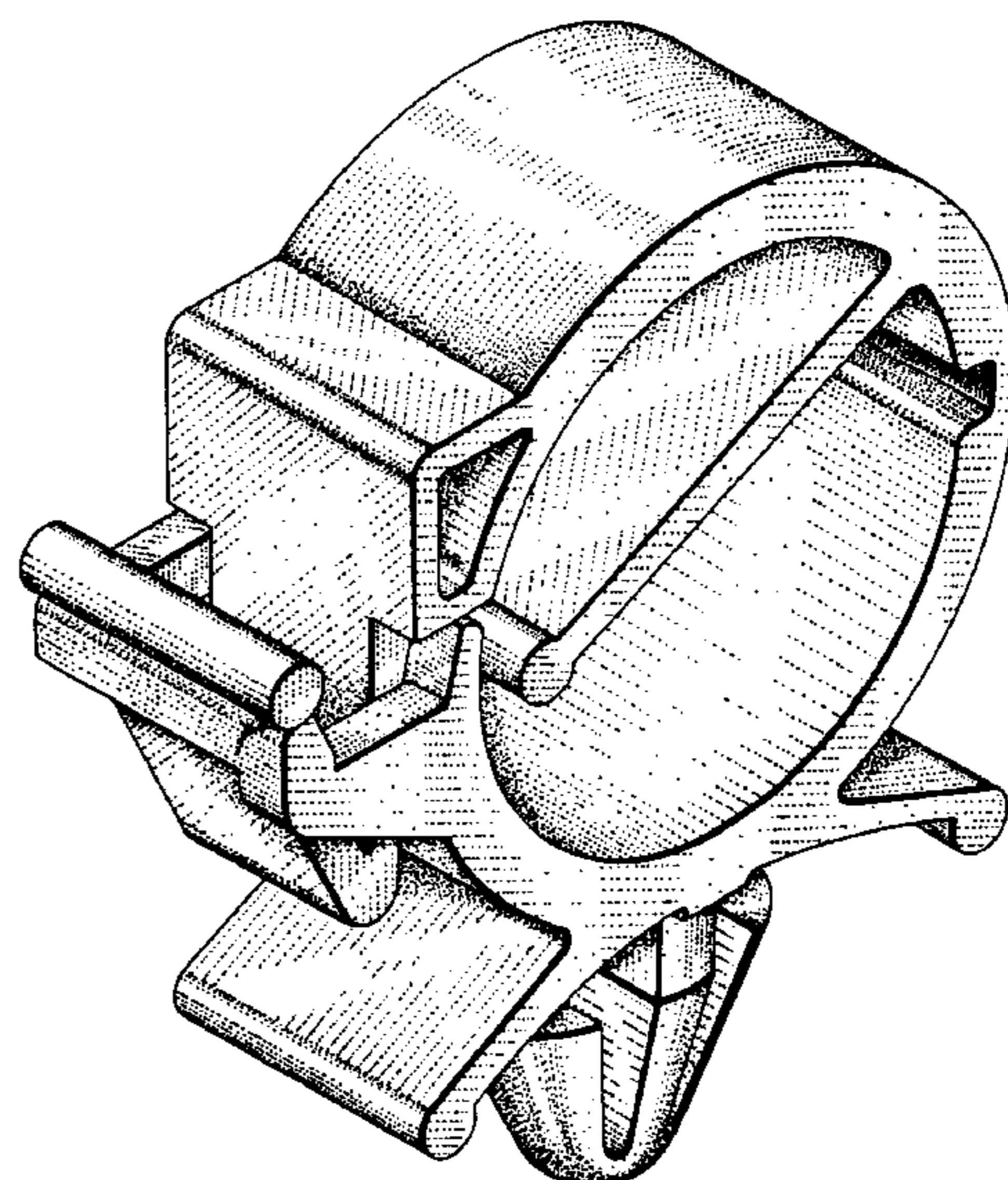
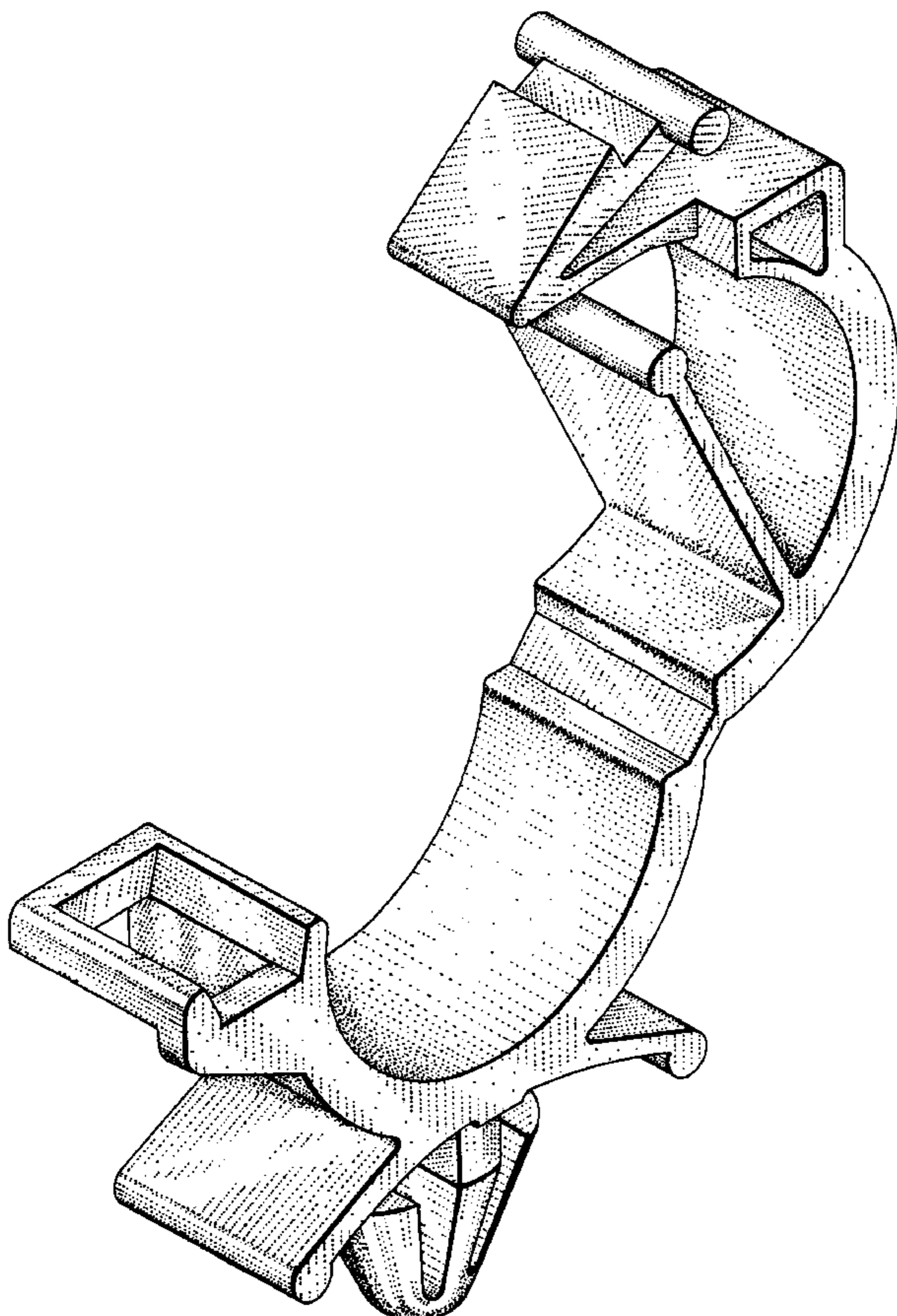

FIG. 1

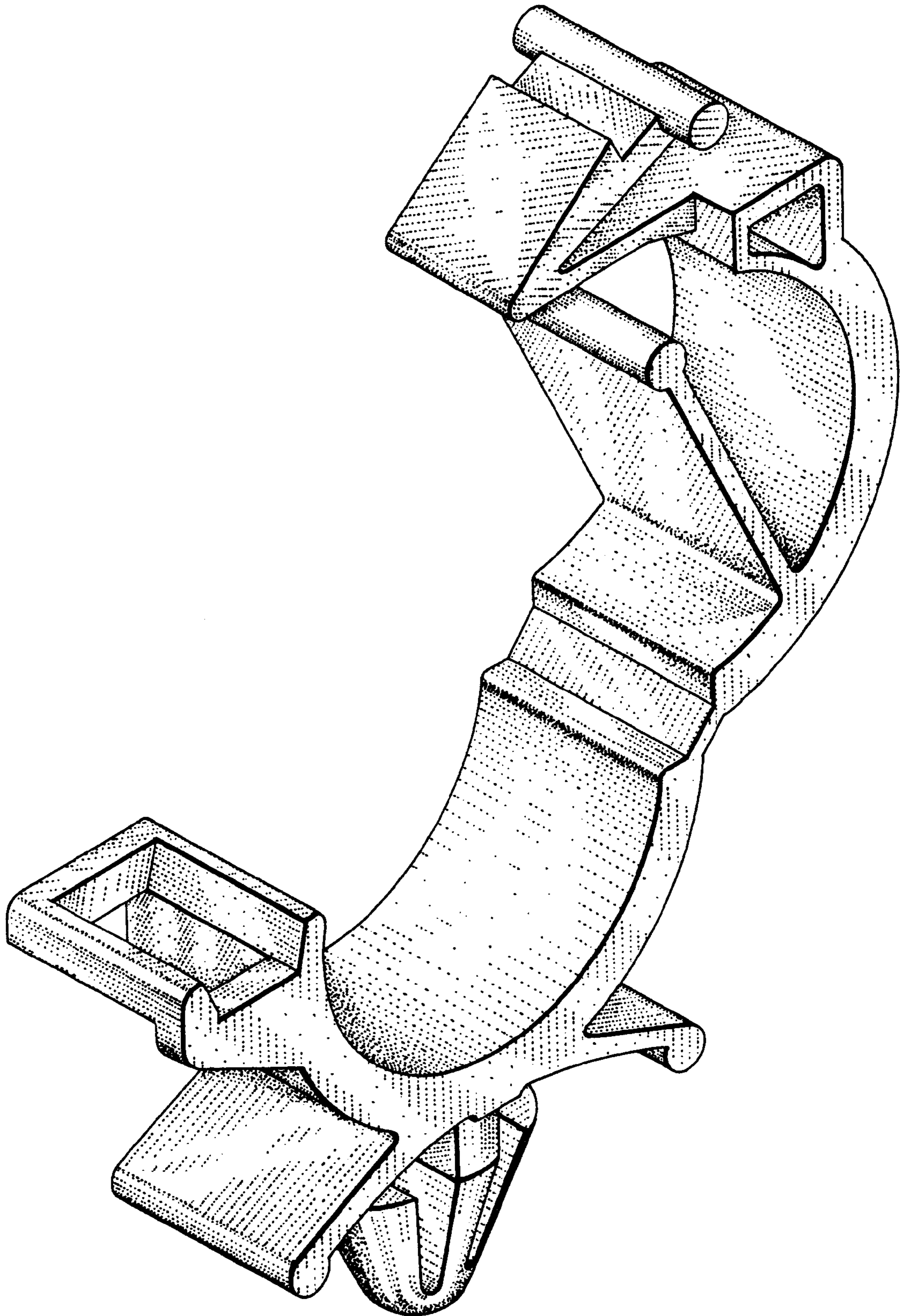

FIG. 2

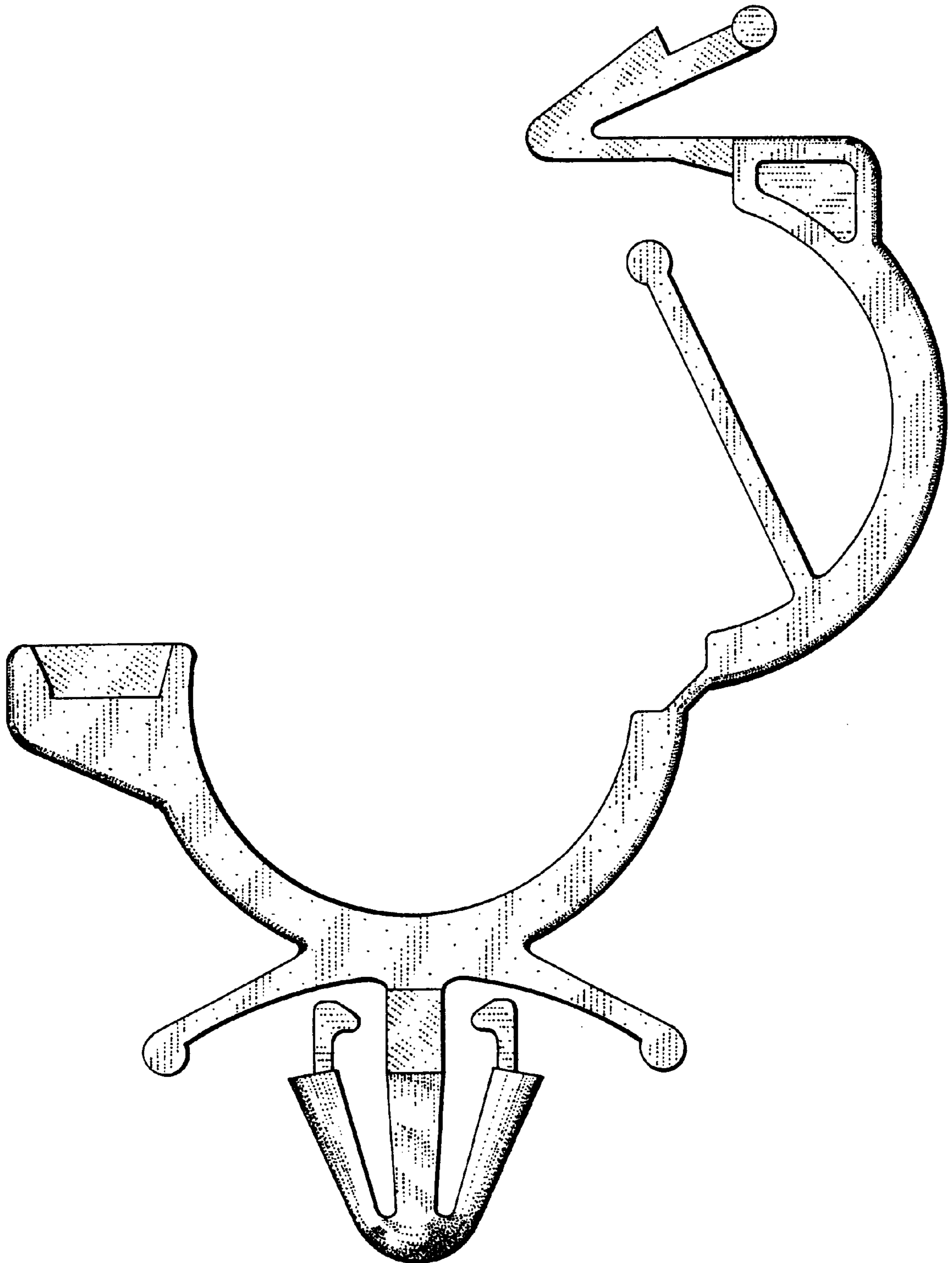

FIG. 3

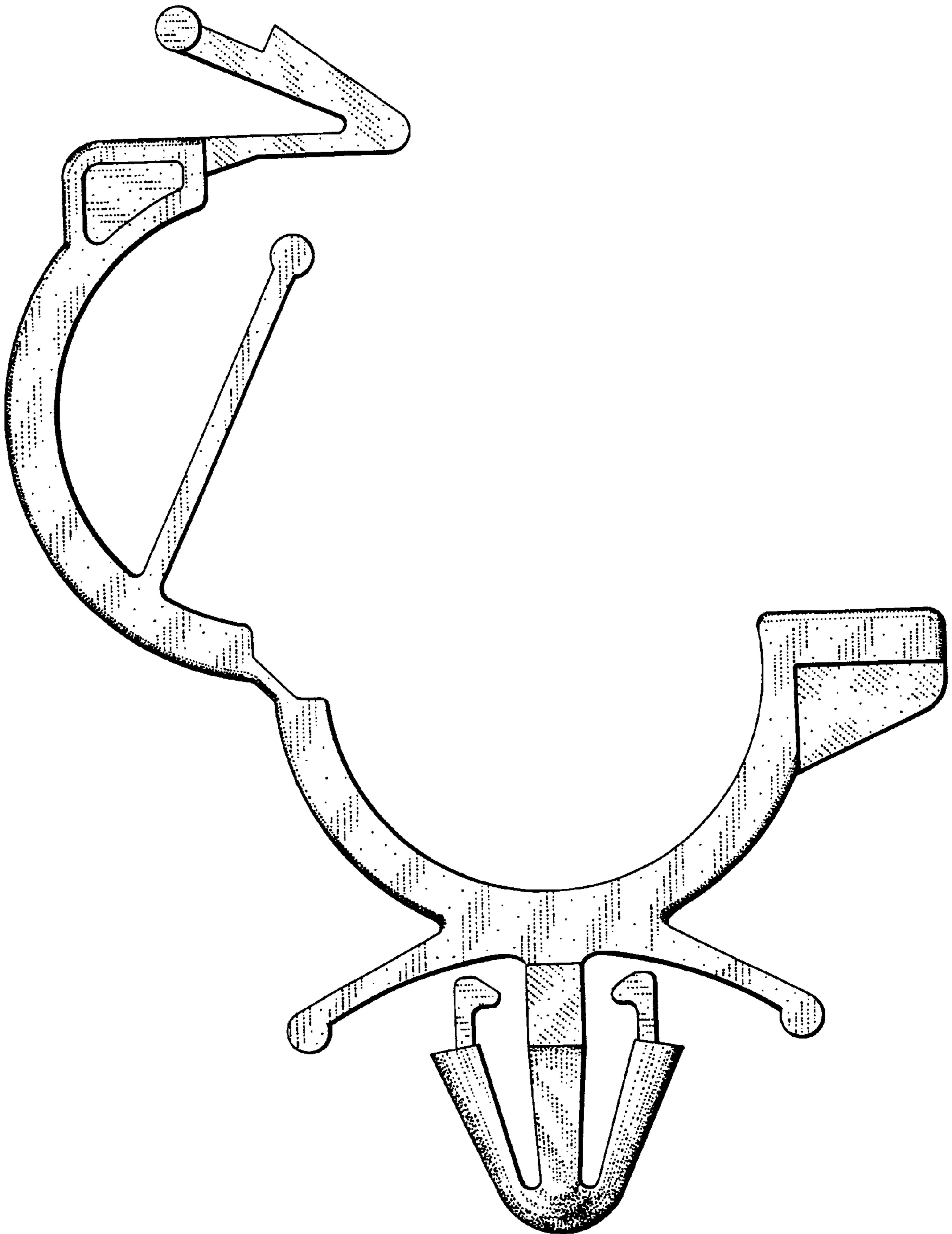

FIG. 4

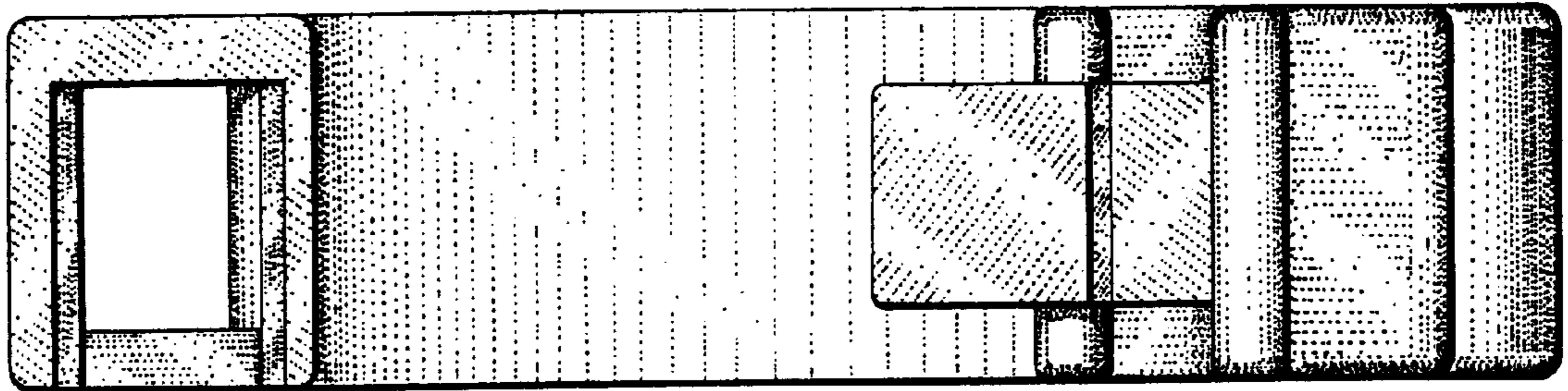

FIG. 5

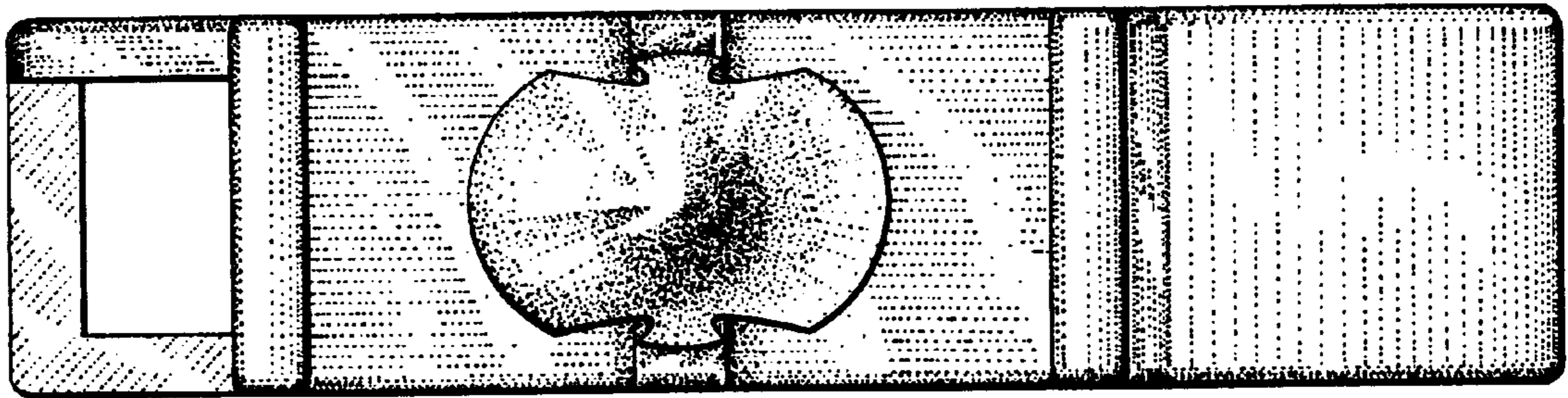

FIG. 6

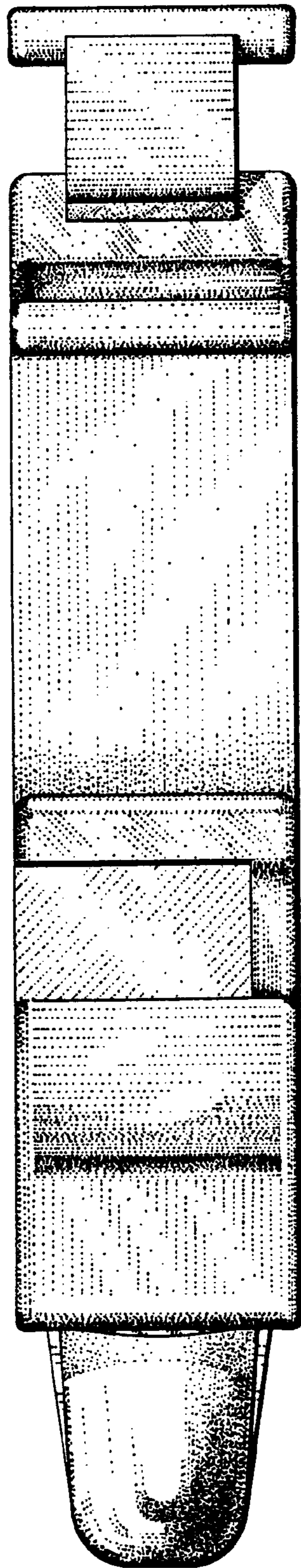

FIG. 7

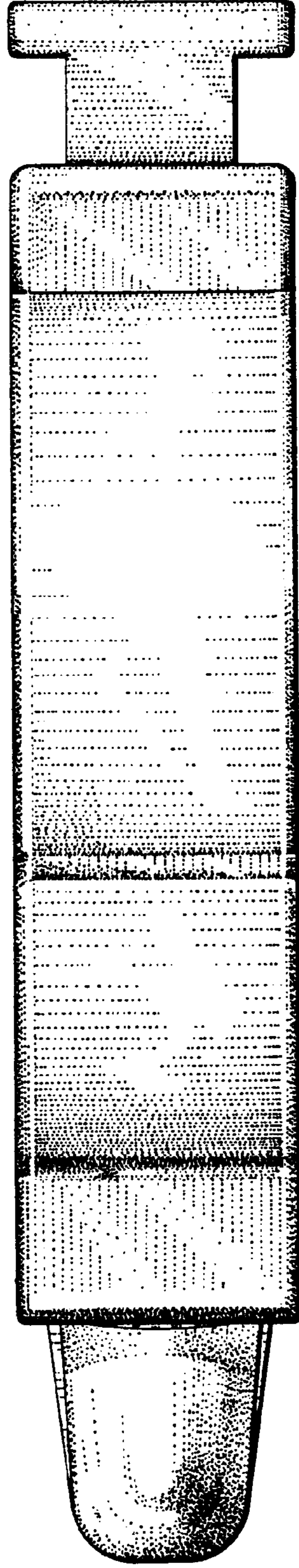

FIG. 8

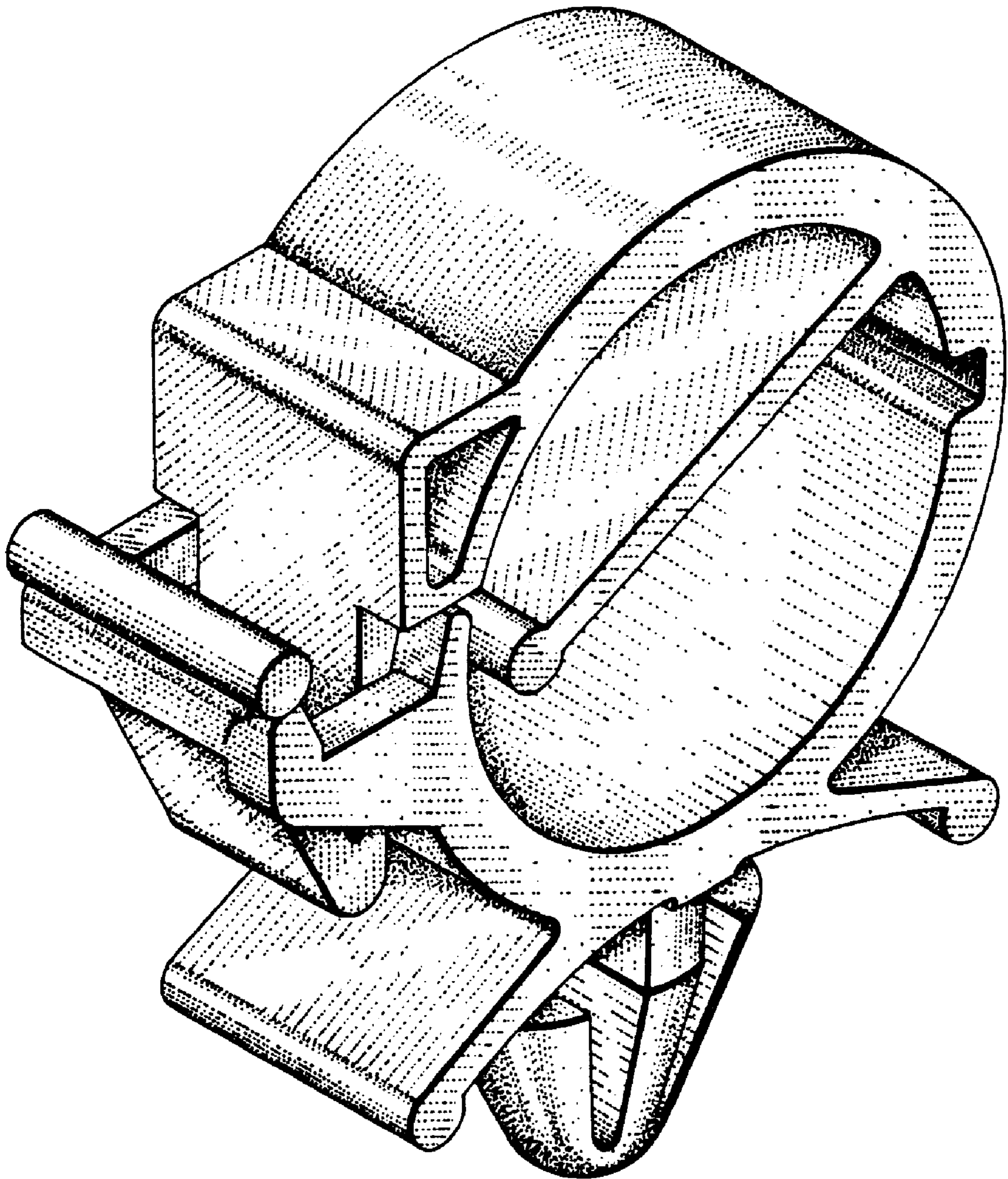

FIG. 9

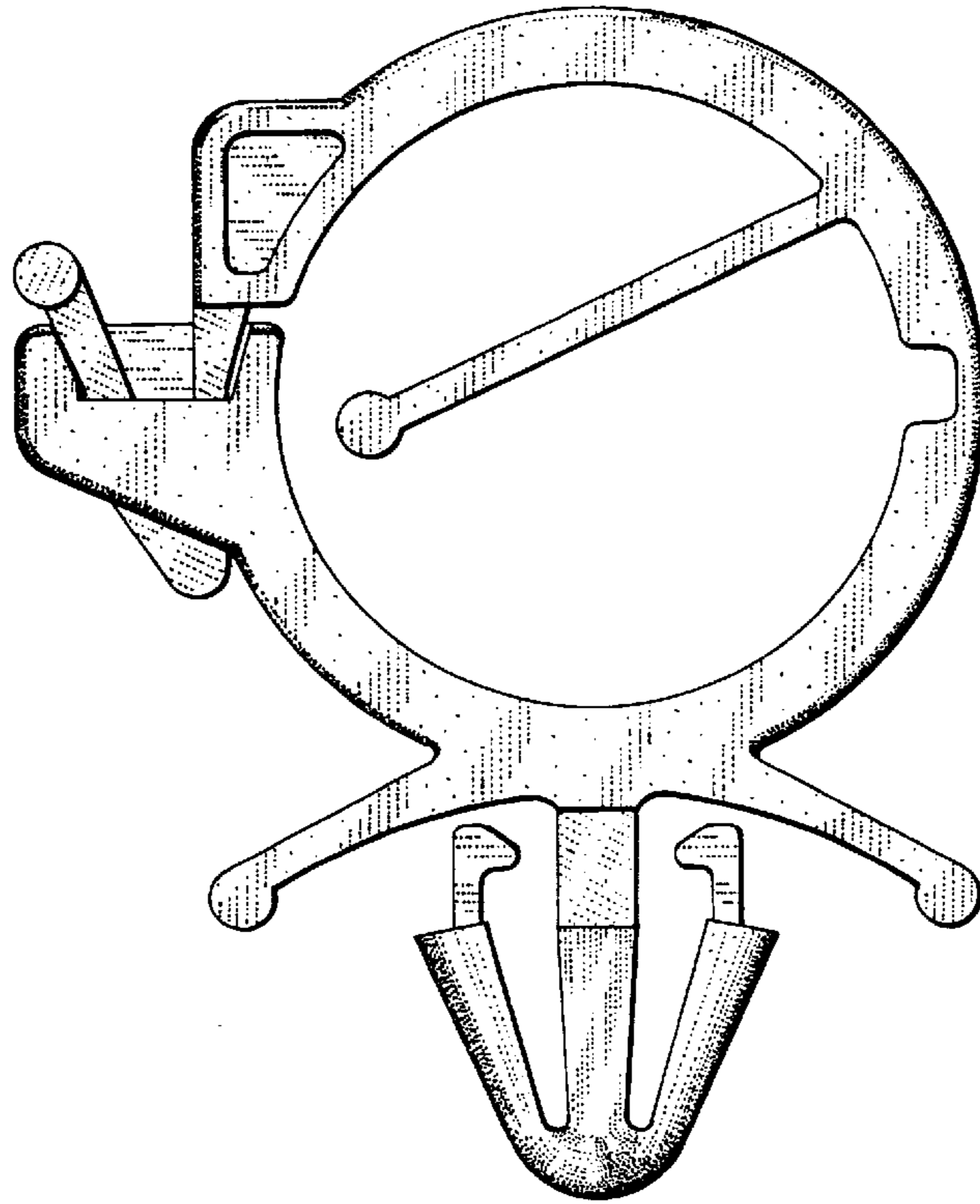

FIG. 10

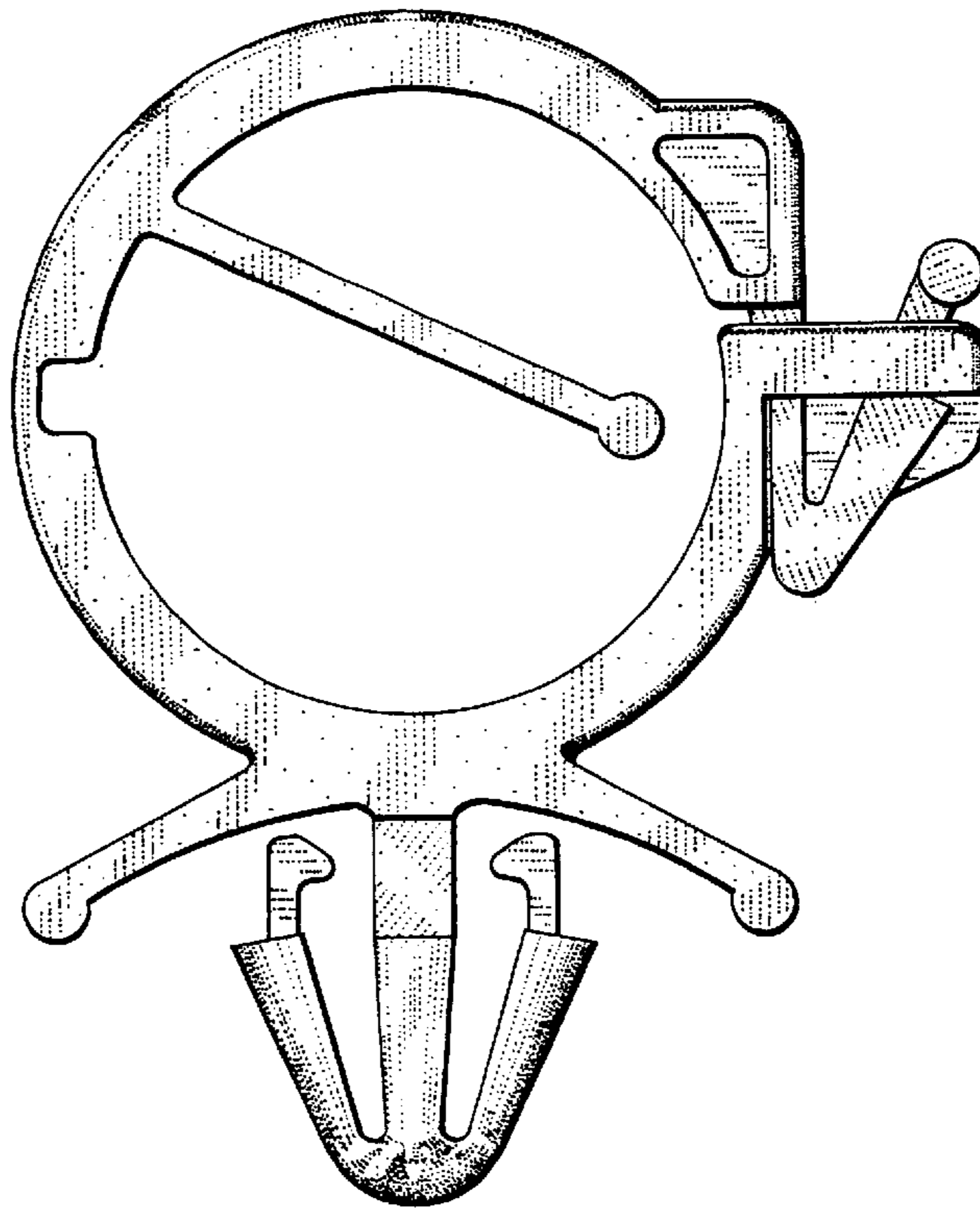

FIG.11

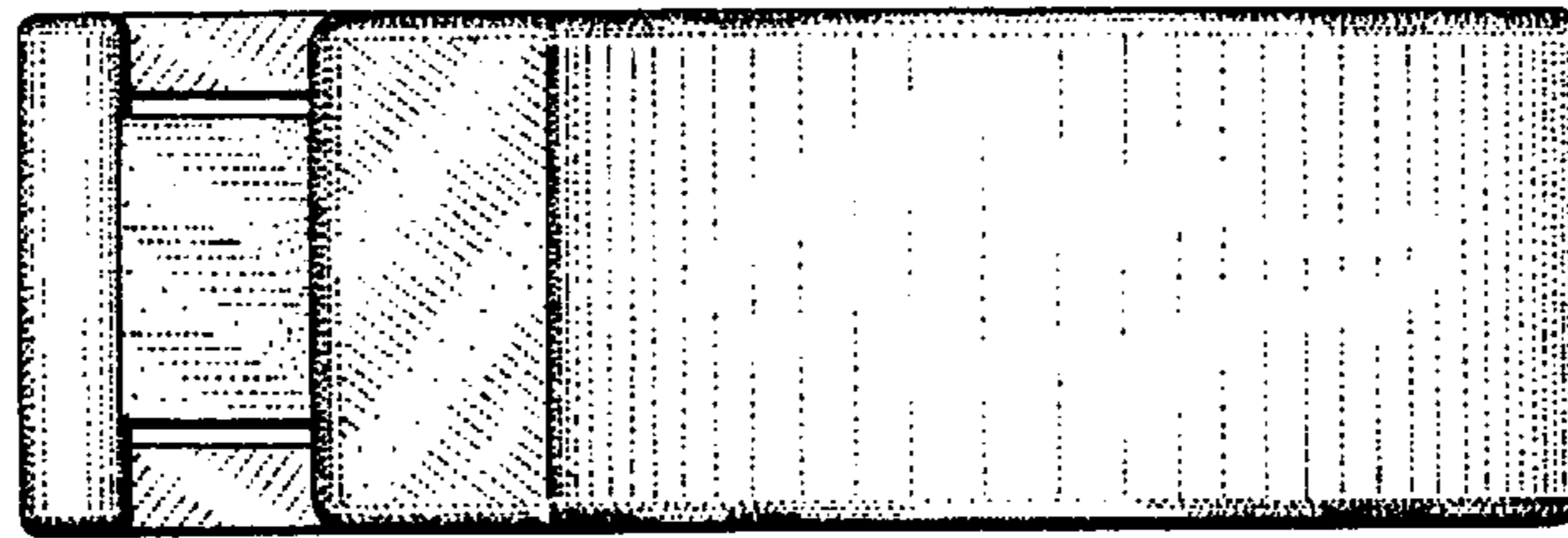

FIG.12

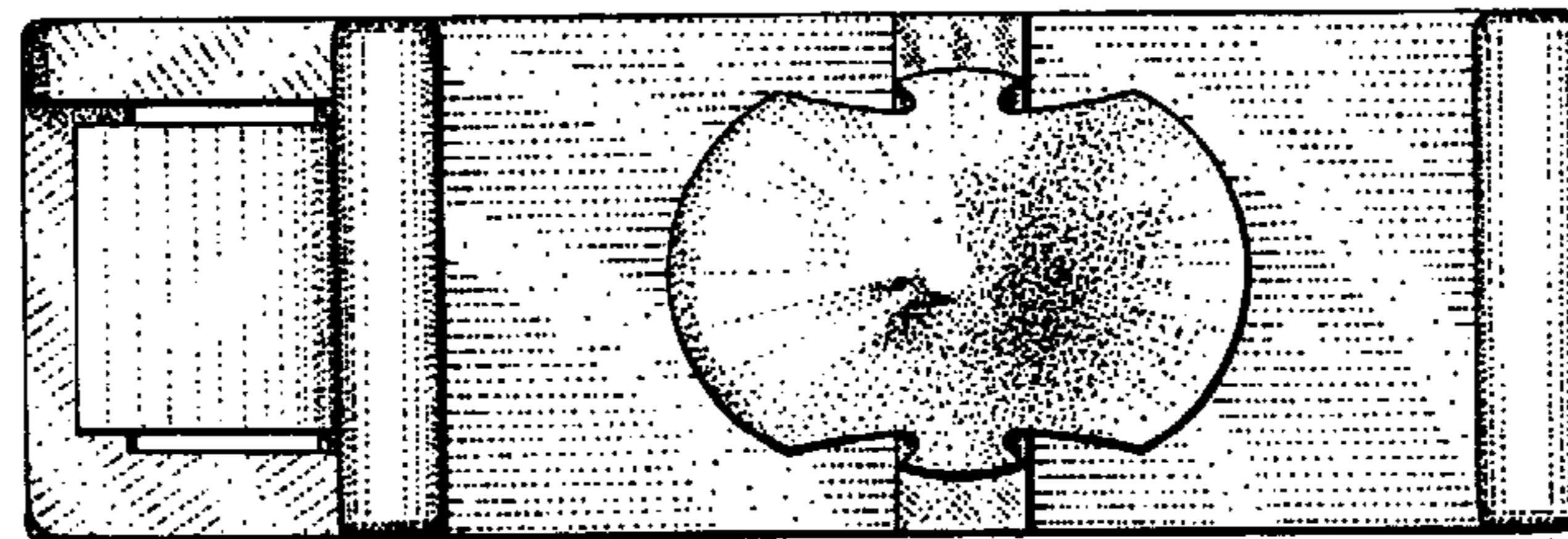

FIG. 13

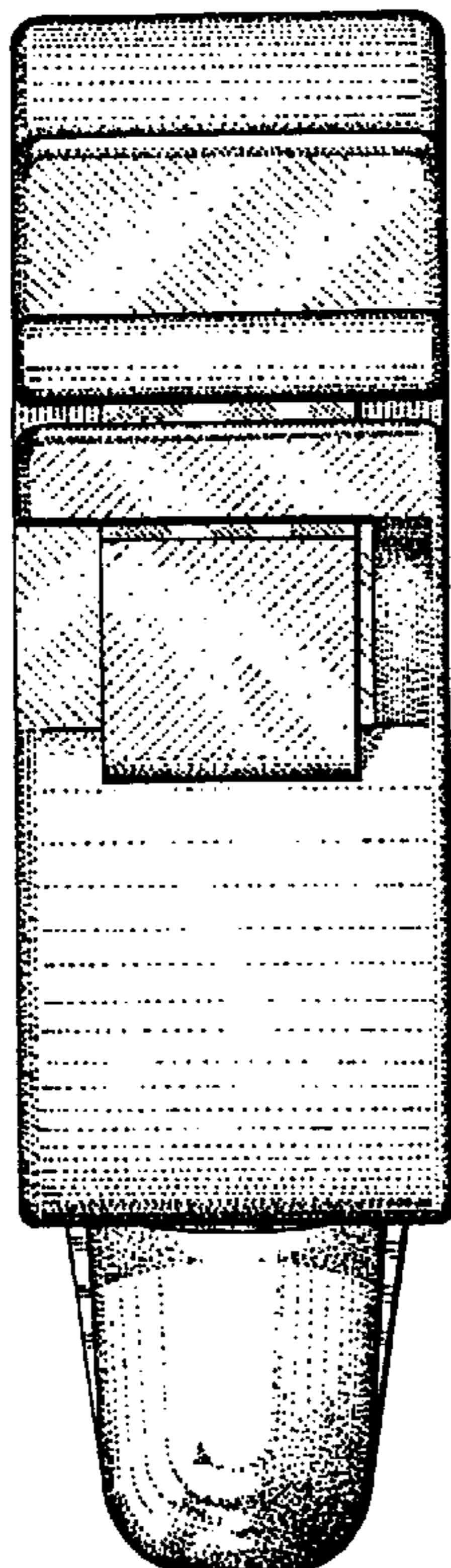

FIG.14

