



US00D414336S

United States Patent [19]
Rasmussen

[11] **Patent Number: Des. 414,336**

[45] **Date of Patent: ** Sep. 28, 1999**

[54] **CONTAINER FOR TOY ELEMENTS**

[75] Inventor: **John Rasmussen**, Randbøl, Denmark

[73] Assignee: **INTERLEGO AG**, Baar, Switzerland

[**] Term: **14 Years**

[21] Appl. No.: **29/092,447**

[22] Filed: **Aug. 19, 1998**

[51] **LOC (6) Cl.** **03-01**

[52] **U.S. Cl.** **D3/282; D3/276**

[58] **Field of Search** D3/269, 272, 273,
D3/276, 281, 282, 291, 294, 905; 206/315.1,
349, 372, 373; 190/110, 111, 112, 113

[56] **References Cited**

U.S. PATENT DOCUMENTS

D. 194,339	1/1963	Harty, Jr.	D3/282
D. 221,317	7/1971	Muller	D3/282
D. 222,012	9/1971	Harris	D3/282
D. 237,419	10/1975	Lapins	D3/282
D. 249,825	10/1978	Hasulak	D3/282
D. 328,189	7/1992	Hillinger	D3/282

D. 336,983	7/1993	Roberts et al.	D3/291
D. 360,757	8/1995	Snetting et al.	D3/276
D. 364,957	12/1995	Turbowitz	D3/276

Primary Examiner—Philip S. Hyder
Attorney, Agent, or Firm—Kane,Dalsimer,Sullivan, Kurucz,
Levy,Eisele and Richard, LLP

[57] **CLAIM**

The ornamental design for a container for toy elements, as shown and described.

DESCRIPTION

FIG. 1 is a top perspective view of the container for toy elements;
FIG. 2 is a bottom perspective view thereof;
FIG. 3 is a front elevational view thereof;
FIG. 4 is a right side elevational view thereof;
FIG. 5 is a left side elevational view thereof;
FIG. 6 is a rear elevational view thereof;
FIG. 7 is a top plan view thereof;
FIG. 8 is a bottom plan view thereof; and,
FIG. 9 is a top perspective view thereof with open lid.

1 Claim, 6 Drawing Sheets

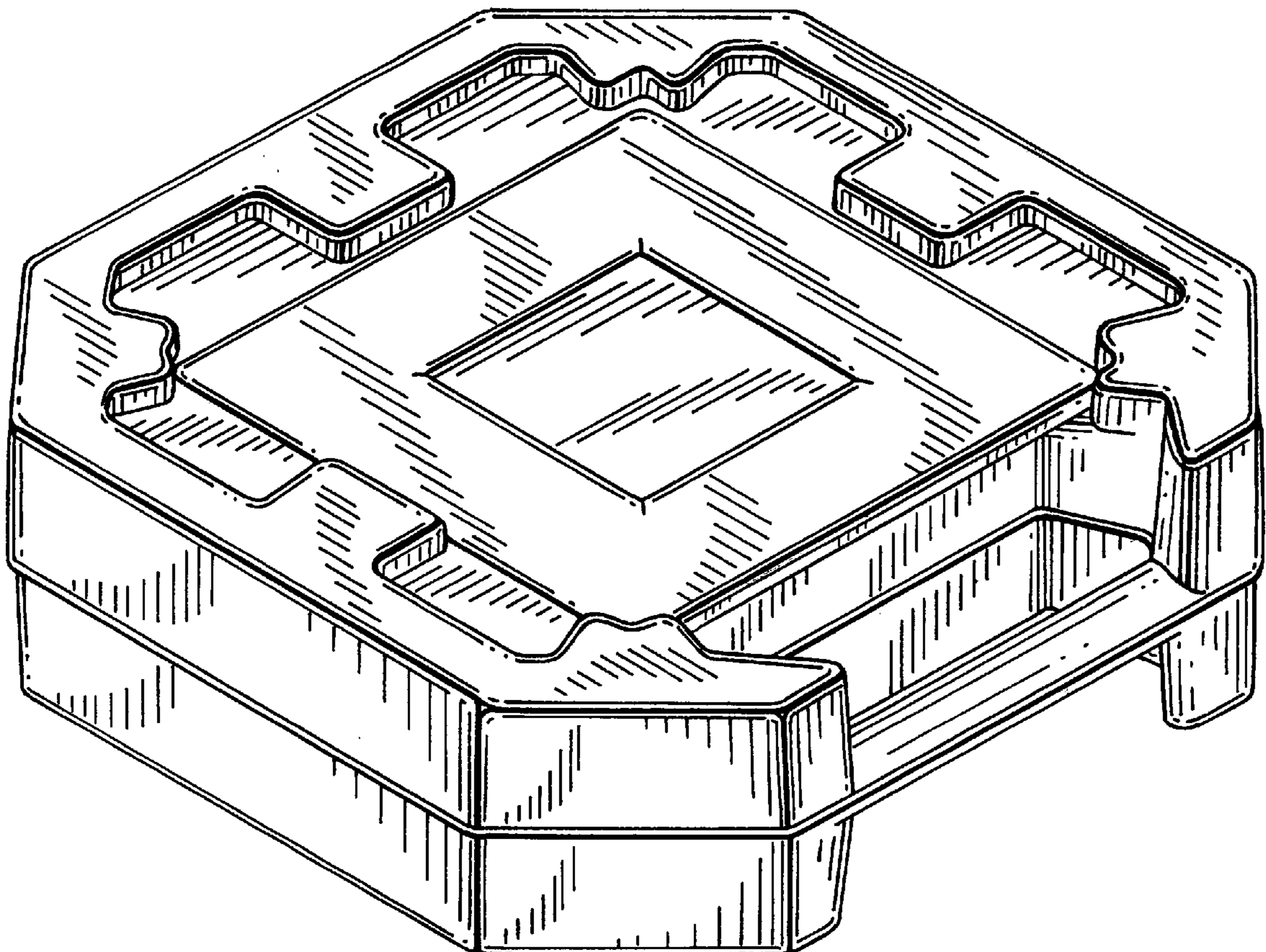

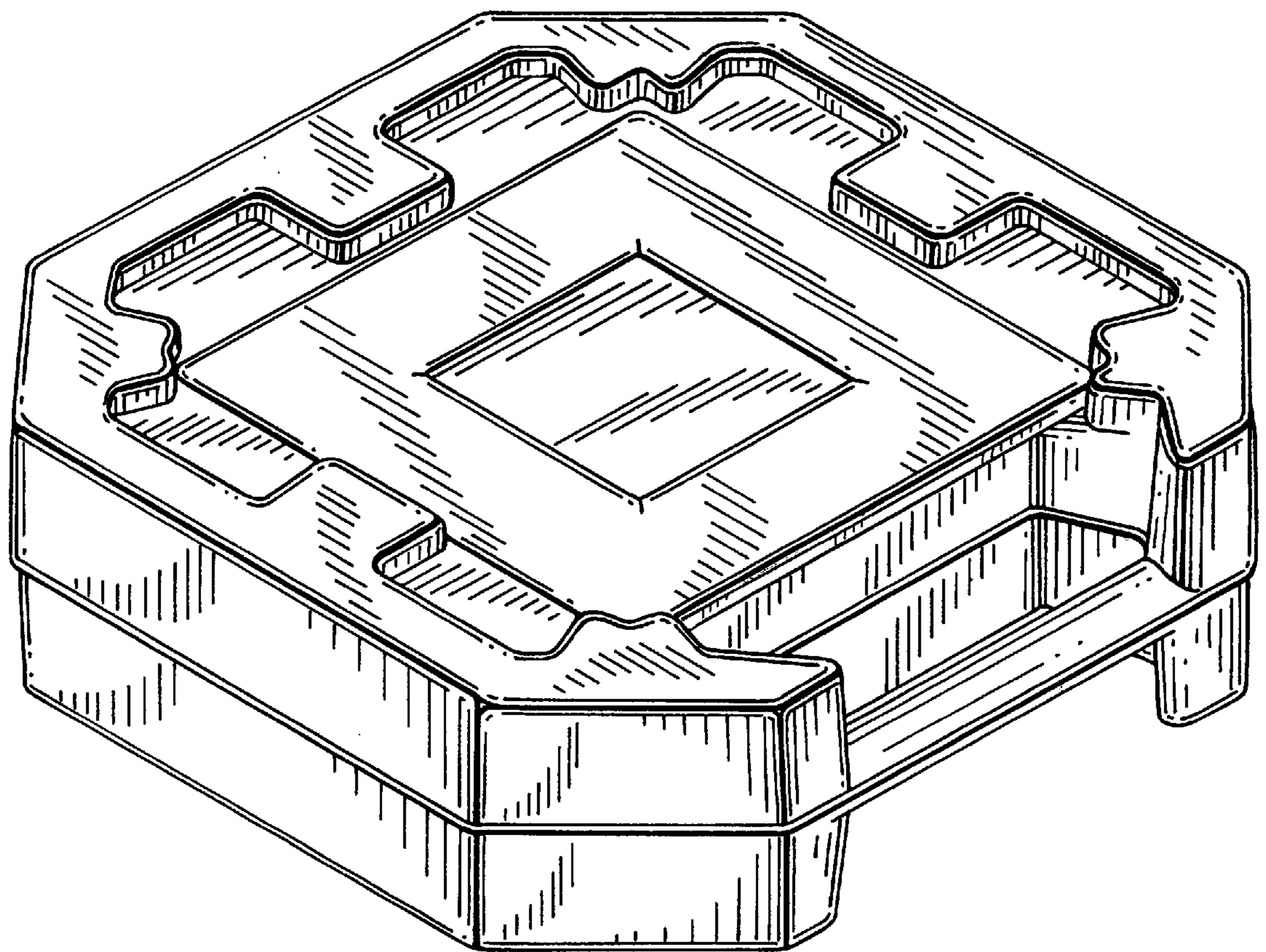

FIG. 1

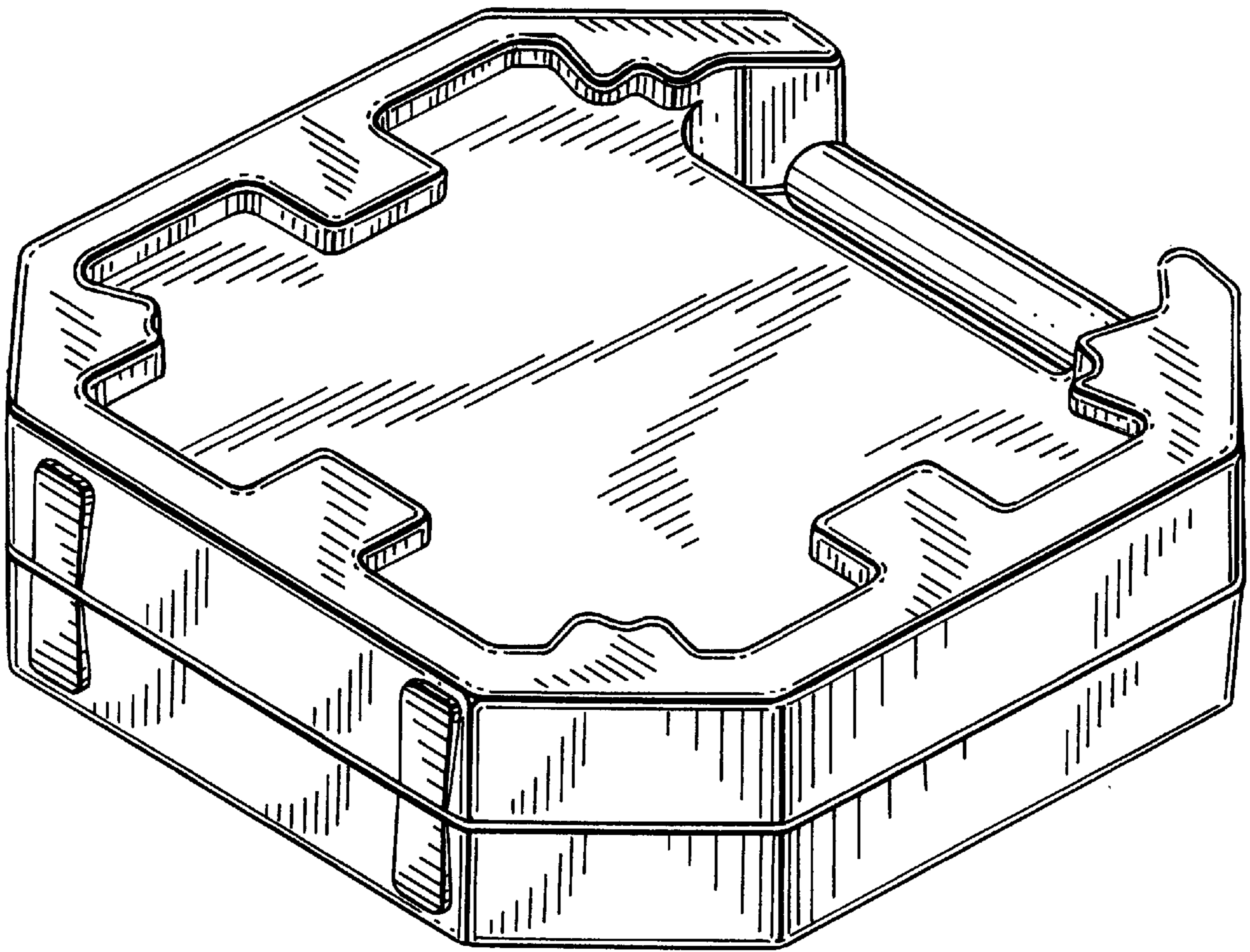

FIG. 2

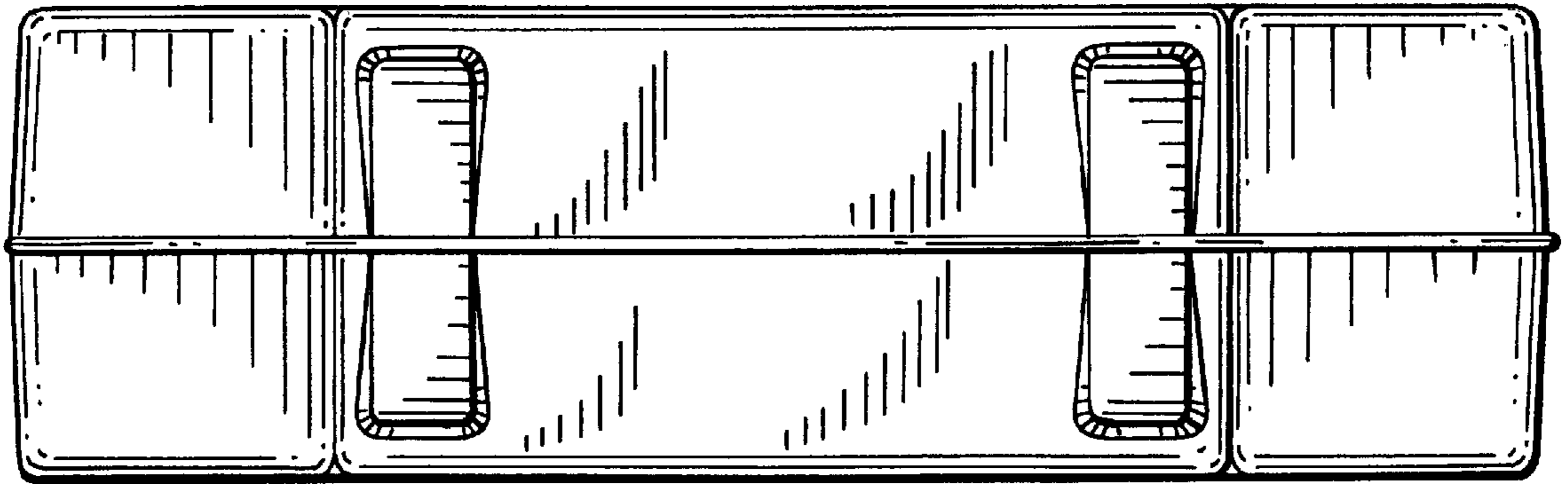

FIG. 6

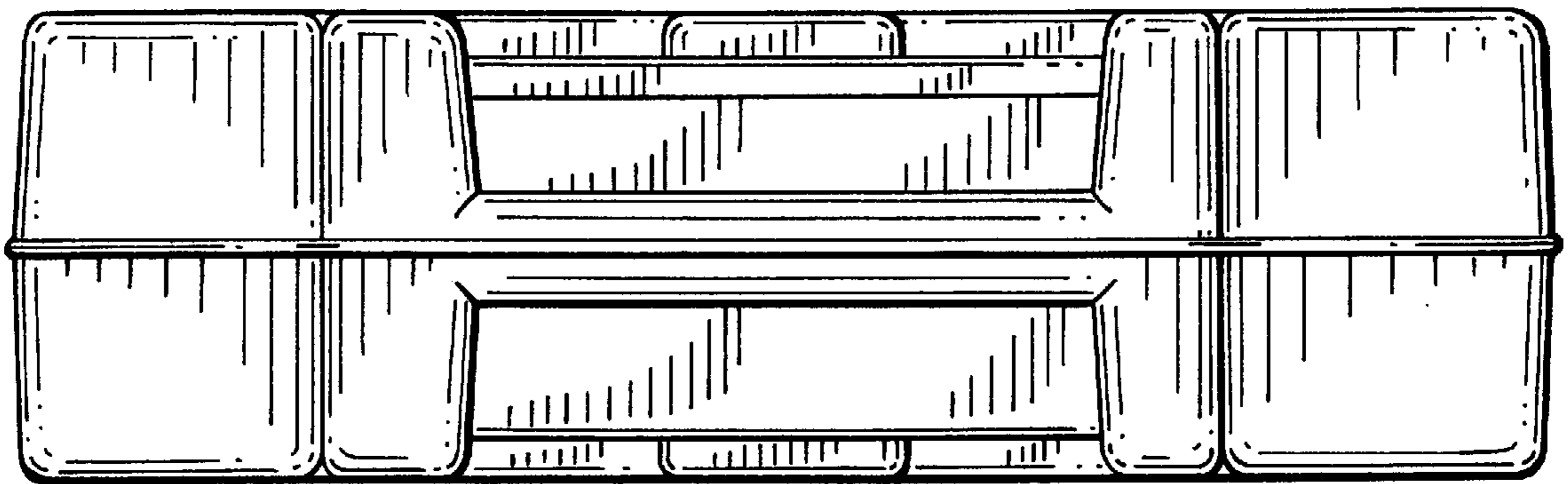

FIG. 3

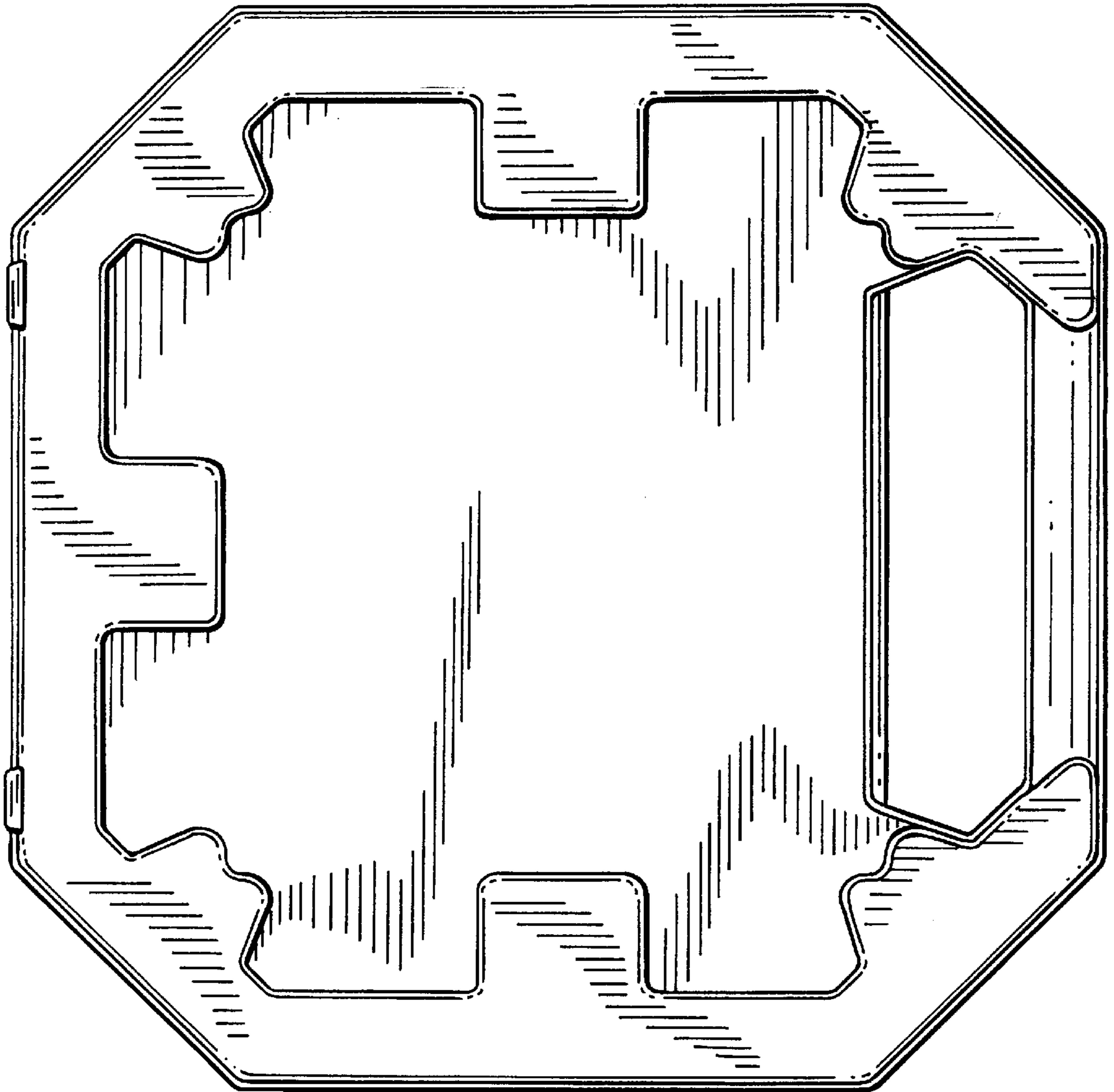

FIG. 8

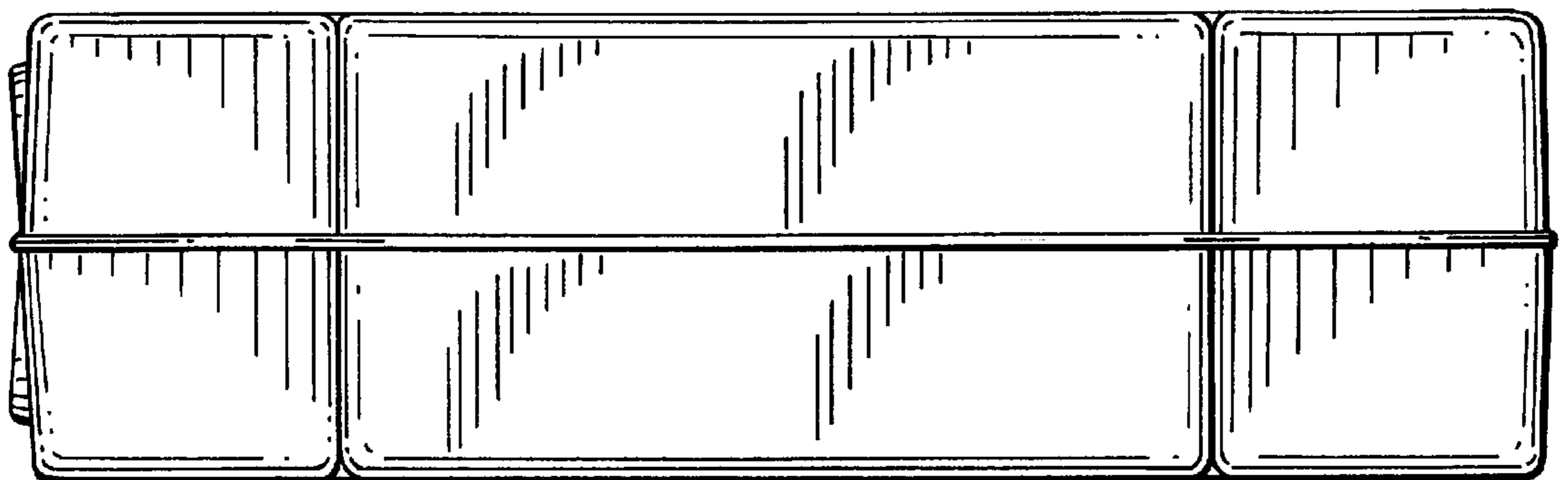

FIG. 4

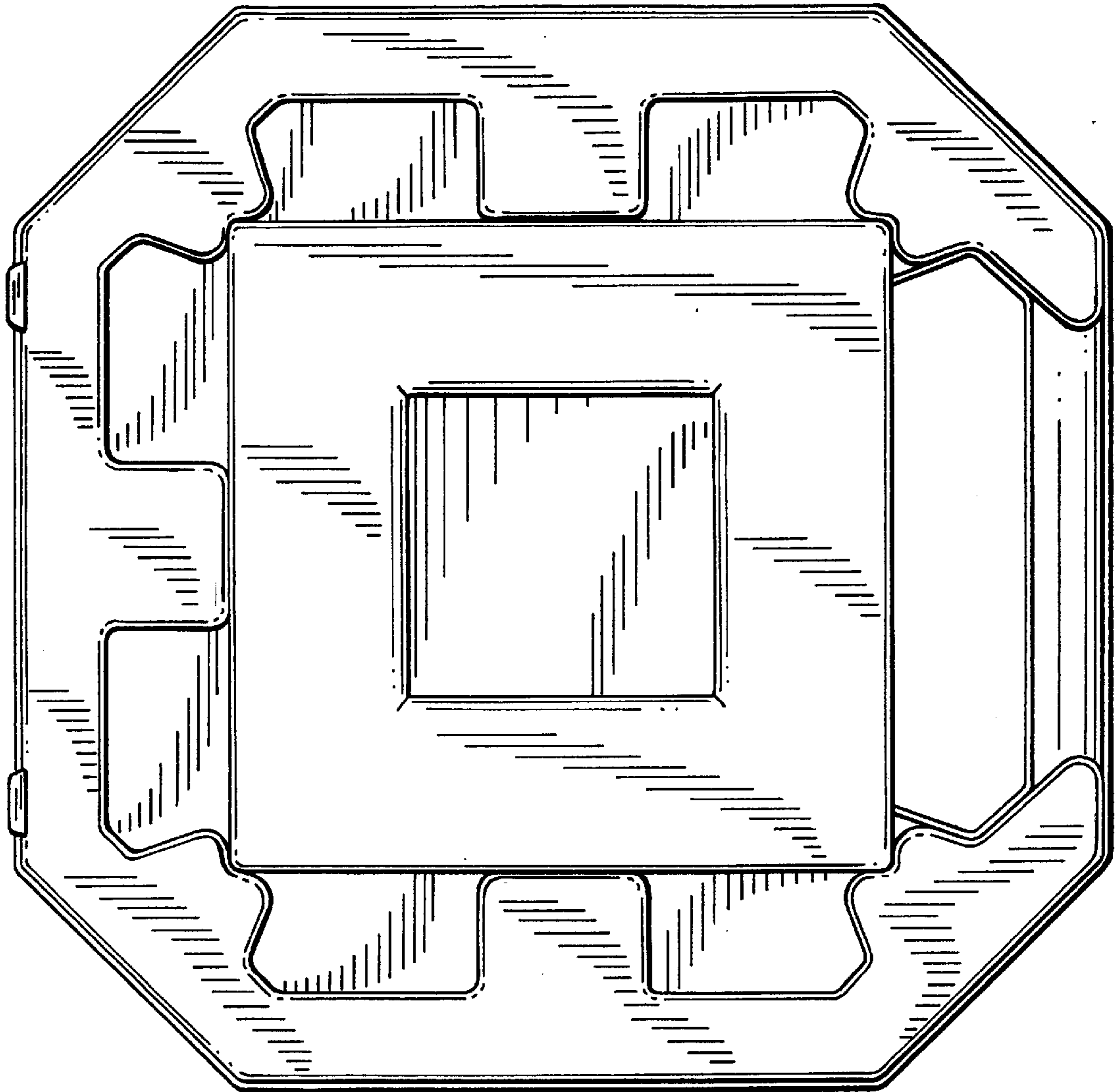

FIG. 7

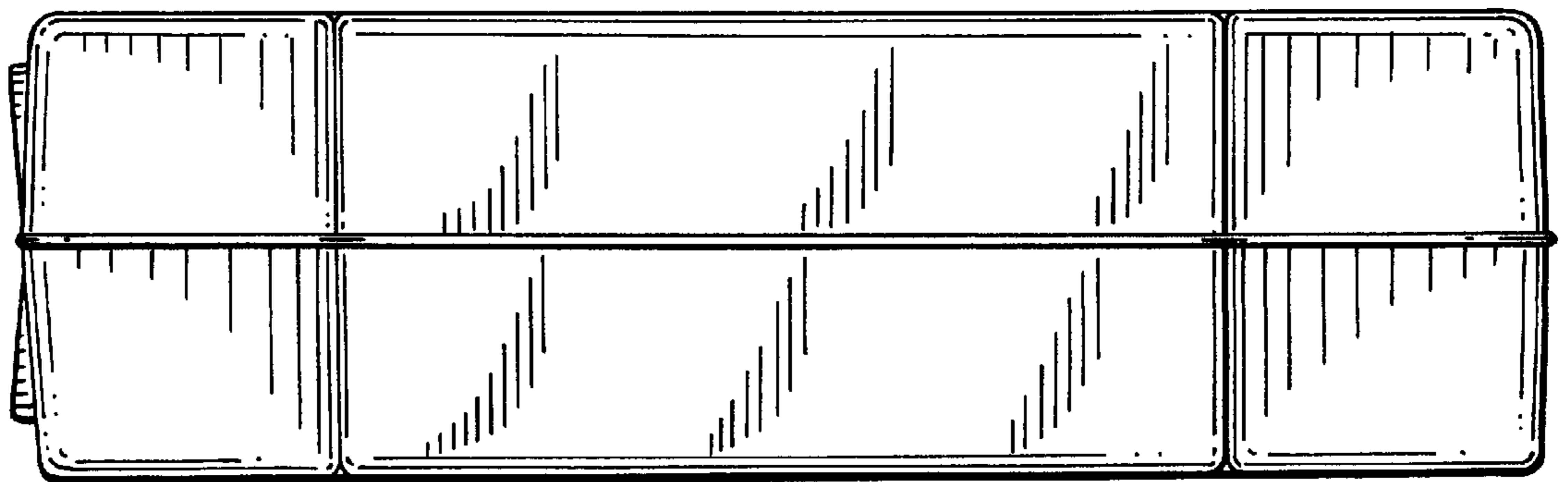

FIG. 5

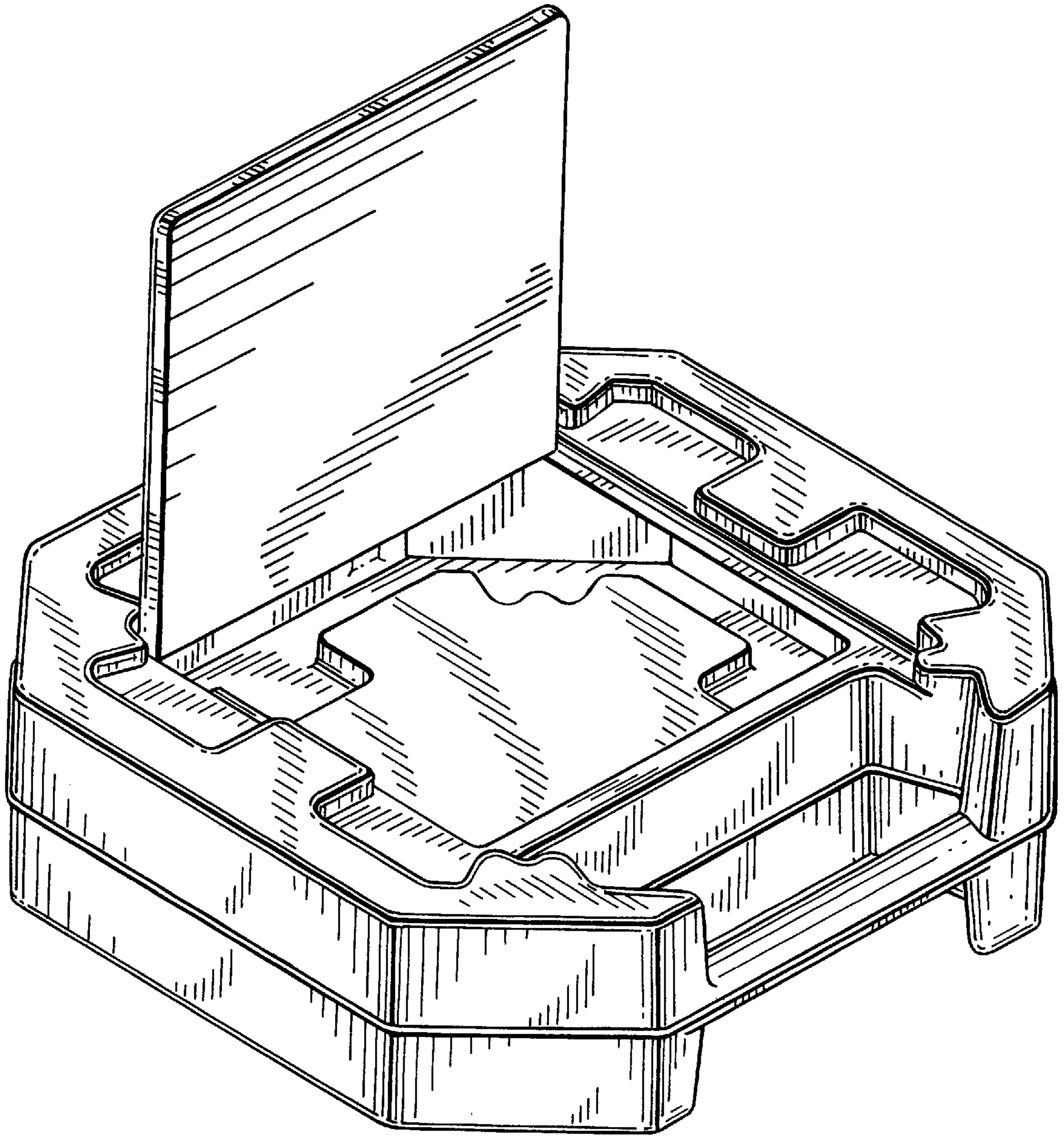

FIG. 9