



US00D414334S

United States Patent [19]
Remington et al.

[11] **Patent Number: Des. 414,334**

[45] **Date of Patent: ** Sep. 28, 1999**

[54] **CIRCULAR SAW BLADE CASE**

Primary Examiner—Philip S. Hyder

[76] Inventors: **John E Remington; Carolyn J Remington**, both of 2310 Remington Rd., Green Bay, Wis. 54302

[57] **CLAIM**

The ornamental design for a circular saw blade case, as shown.

[**] Term: **14 Years**

DESCRIPTION

[21] Appl. No.: **29/064,361**

FIG. 1 is a front view of the circular saw blade case of the present invention;

[22] Filed: **Dec. 30, 1996**

FIG. 2 is a rear view of the circular saw blade case of FIG. 1;

[51] **LOC (6) Cl.** **03-01**

[52] **U.S. Cl.** **D3/276; D3/294**

FIG. 3 is a left side view of the circular saw blade case of FIG. 1;

[58] **Field of Search** D3/274, 273, 282, D3/281, 276; 220/331, 555; 206/349, 372, 373

FIG. 4 is a right side view of the circular saw blade case of FIG. 1;

[56] **References Cited**

U.S. PATENT DOCUMENTS

D. 314,667	2/1991	Hussain	D3/274
D. 343,731	2/1994	Tsumita	D3/282
D. 348,903	7/1994	Fischtein et al.	D3/282
D. 367,557	3/1996	Chang	D3/281
D. 368,159	3/1996	Calmeise et al.	D3/282
D. 368,371	4/1996	Calmeise	D3/276
5,203,469	4/1993	Chang et al.	206/372
5,429,235	7/1995	Chen	206/373

FIG. 5 is a top view of the circular saw blade case of FIG. 1;

FIG. 6 is a bottom view of the circular saw blade case of FIG. 1; and,

FIG. 7 is a perspective view of the circular saw blade case of FIG. 1, wherein the cover is shown in an open position. The broken line showing of the saw blade in FIG. 7 is for illustrative purposes only and forms no part of the claimed design.

1 Claim, 4 Drawing Sheets

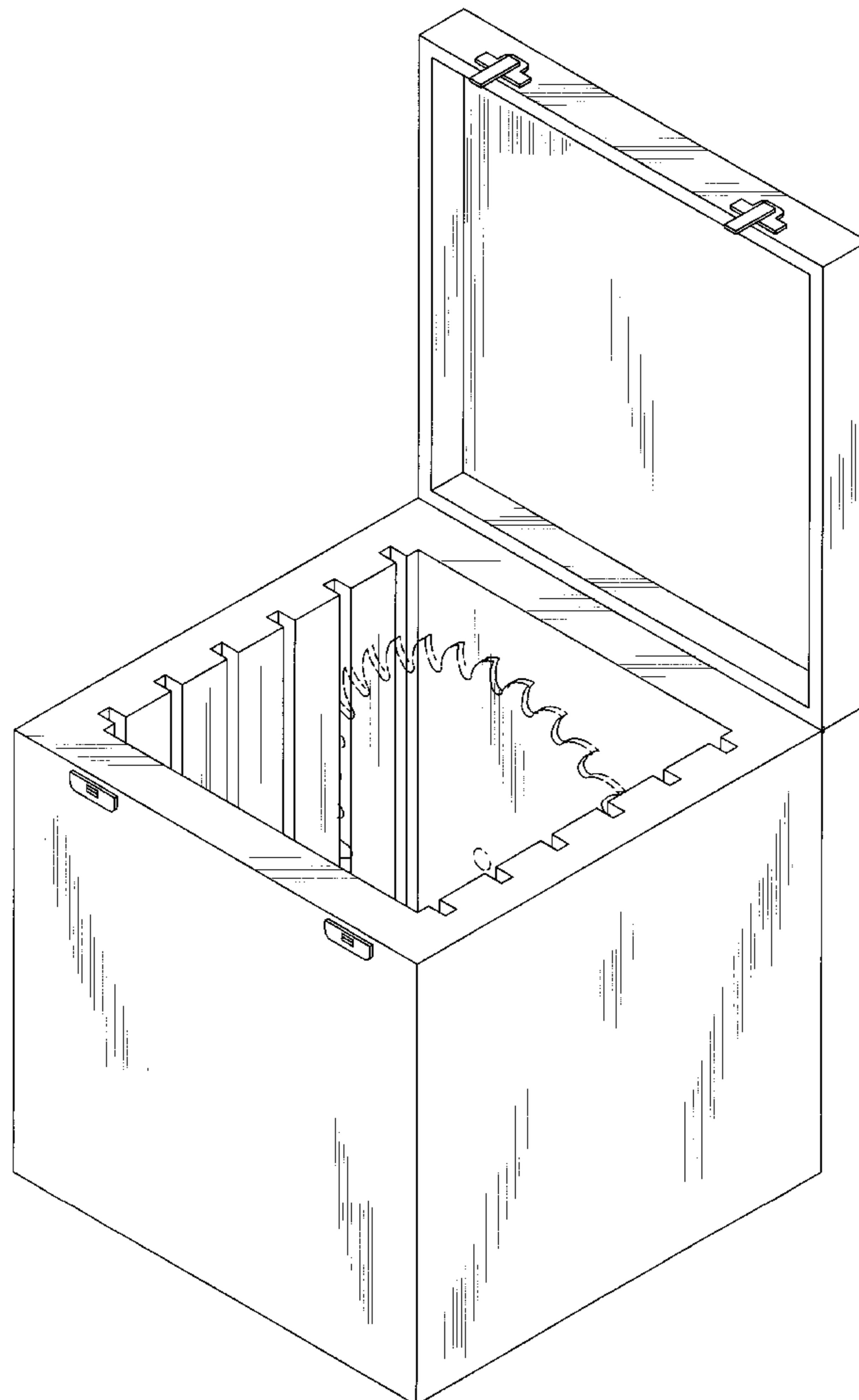

FIG. 1

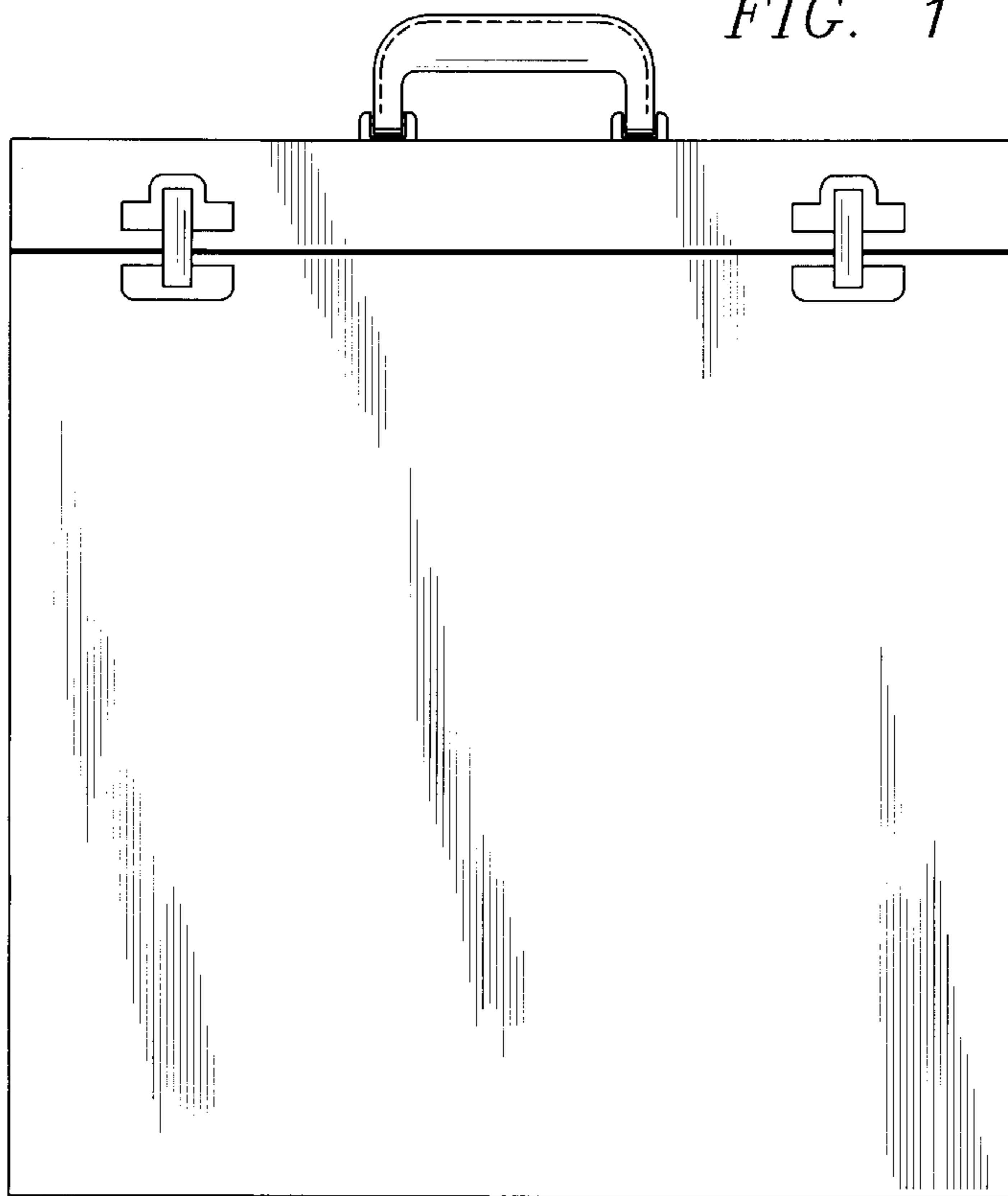
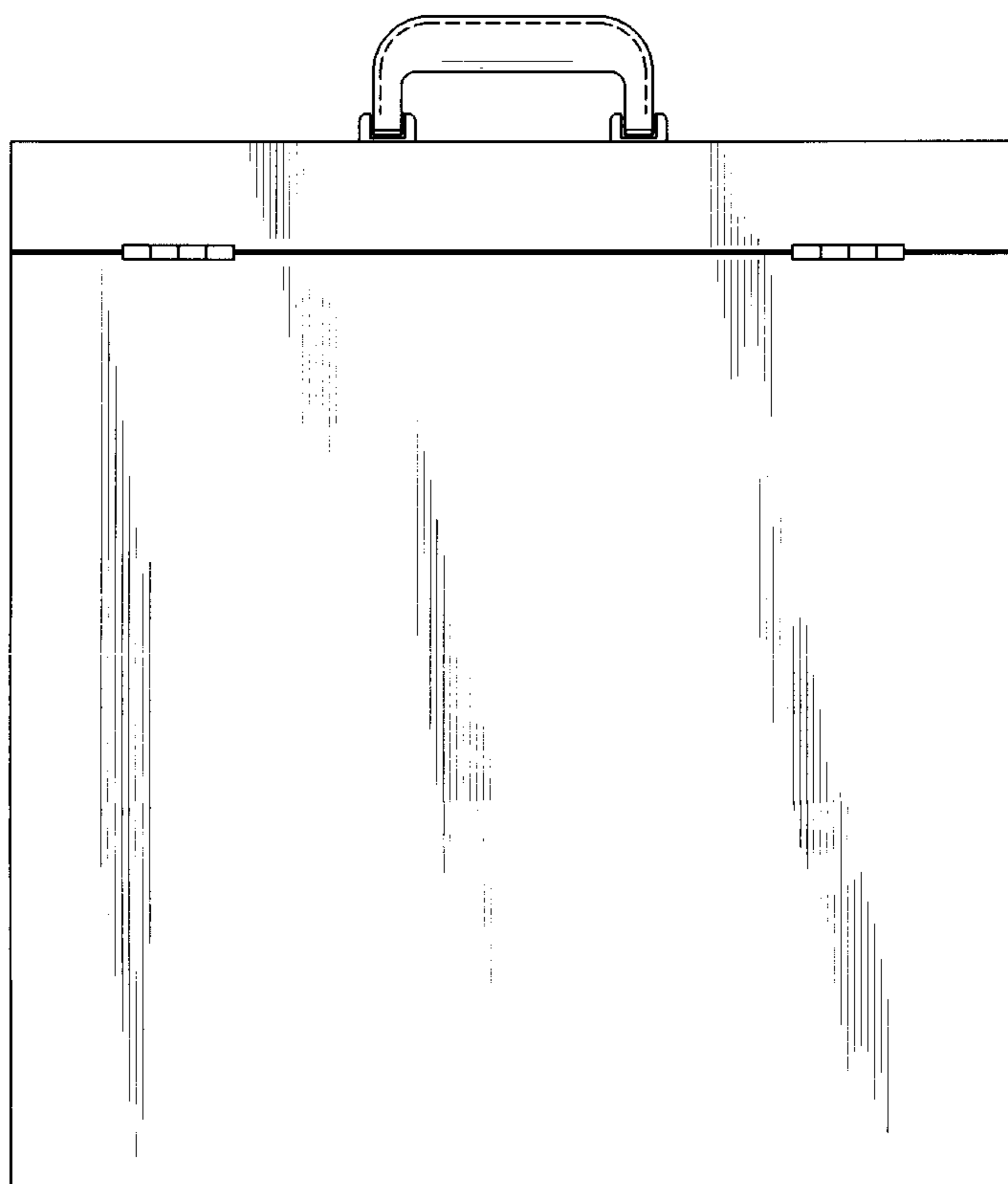

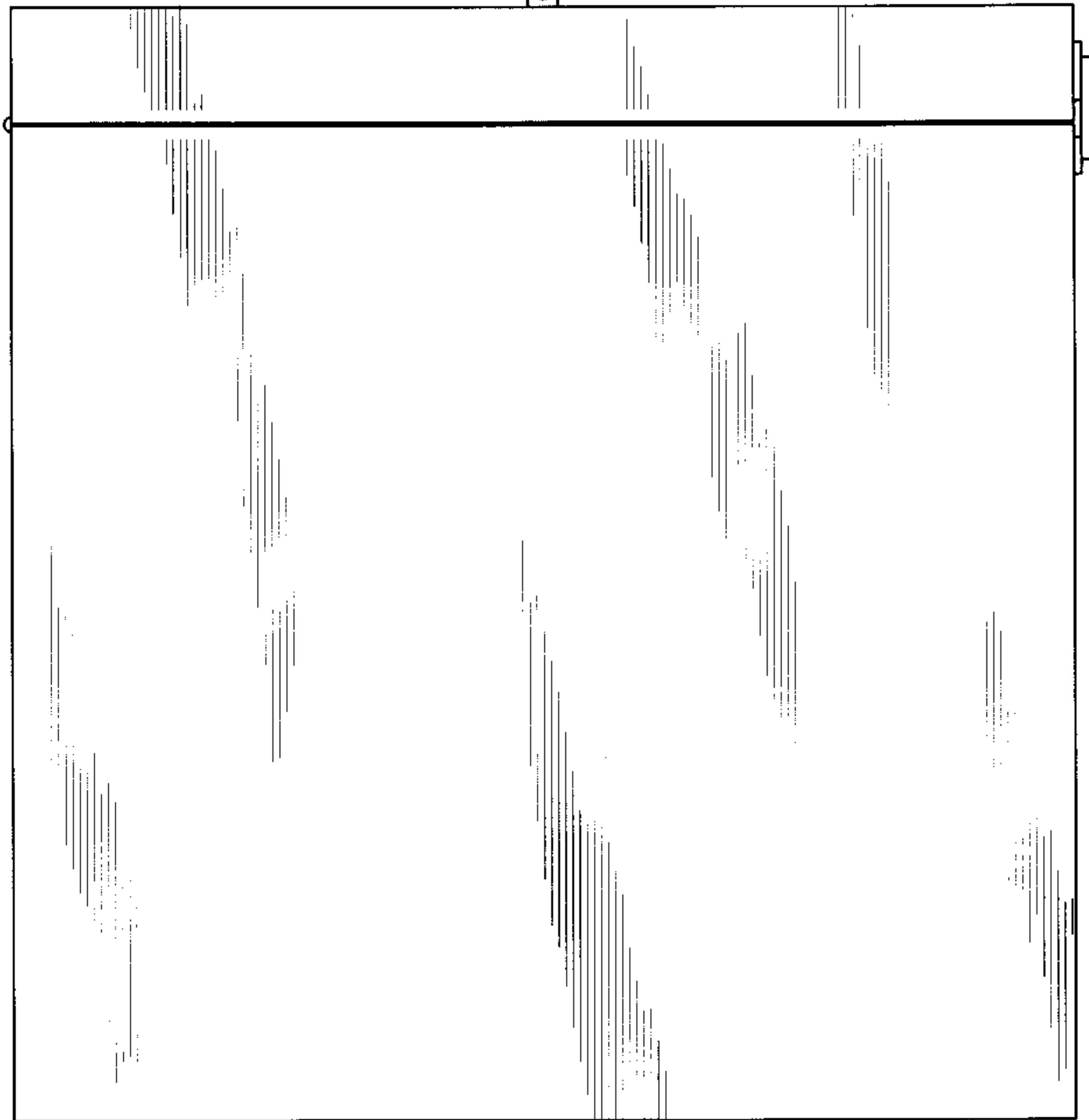



FIG. 2



 *FIG. 3*



 *FIG. 4*

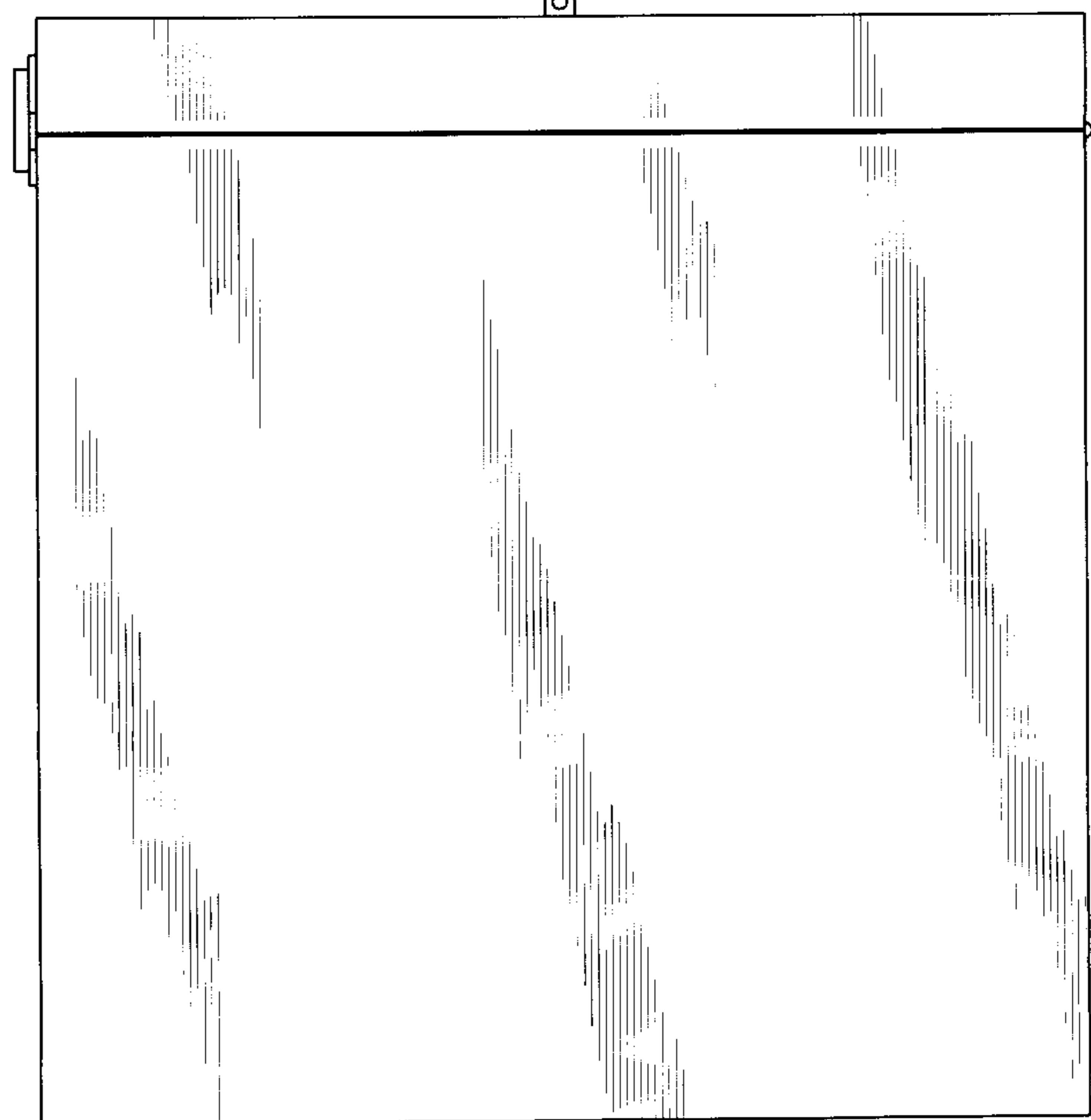

FIG. 5

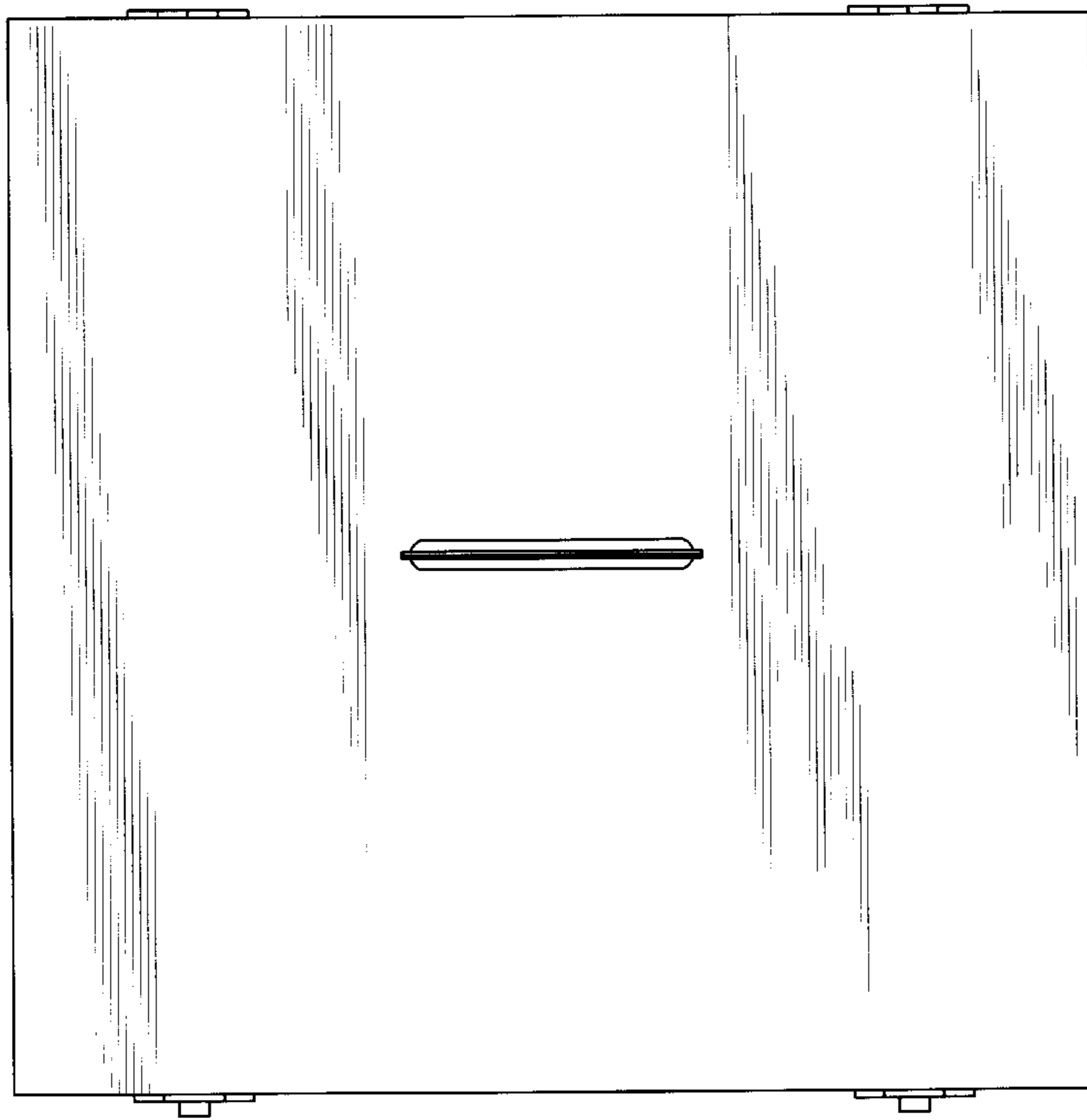

FIG. 6

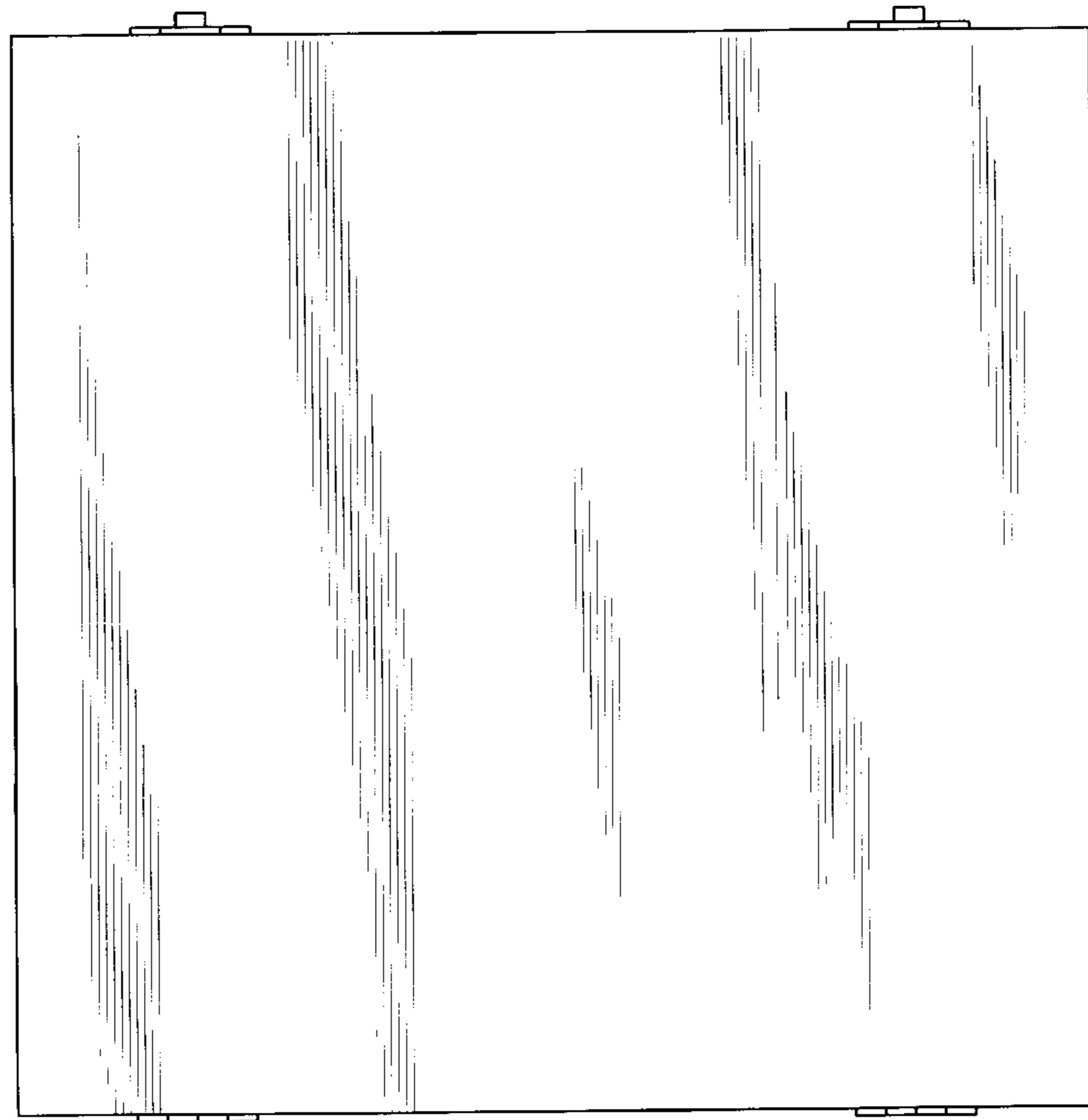

FIG. 7

