



US00D414232S

United States Patent [19]

Just et al.

[11] **Patent Number: Des. 414,232**

[45] **Date of Patent: ** Sep. 21, 1999**

[54] **WOODEN GOLF CLUB HEAD**

[75] Inventors: **Elmore A. Just; Vernon D. Godown,**
both of Louisville, Ky.

[73] Assignee: **Louisville Golf Club Company, Inc.,**
Louisville, Ky.

[**] Term: **14 Years**

[21] Appl. No.: **29/064,944**

[22] Filed: **Jan. 15, 1997**

[51] **LOC (6) Cl. 21-02**

[52] **U.S. Cl. D21/738**

[58] **Field of Search D21/217-219;**
473/251-255, 340, 341, 324

[56] **References Cited**

PUBLICATIONS

Golf World; p. 7; "Con-sole Transit" putter Oct. 1976.

Primary Examiner—Ted Shooman

Assistant Examiner—Mitchell I. Siegel

Attorney, Agent, or Firm—David Kiewit

[57] **CLAIM**

The ornamental design for a wooden golf club head, as shown and described.

DESCRIPTION

FIG. 1 is a perspective view of a wooden golf club head showing our new design.

FIG. 2 is a front elevational view thereof.

FIG. 3 is a top plan view thereof.

FIG. 4 is a right elevational view thereof.

FIG. 5 is a left side elevational view thereof.

FIG. 6 is a rear elevational view thereof; and,

FIG. 7 is a bottom plan view thereof.

The broken line showing of a fragmented shaft and inlaid striking insert is for illustrative purposes only and forms no part of the claimed design.

1 Claim, 2 Drawing Sheets

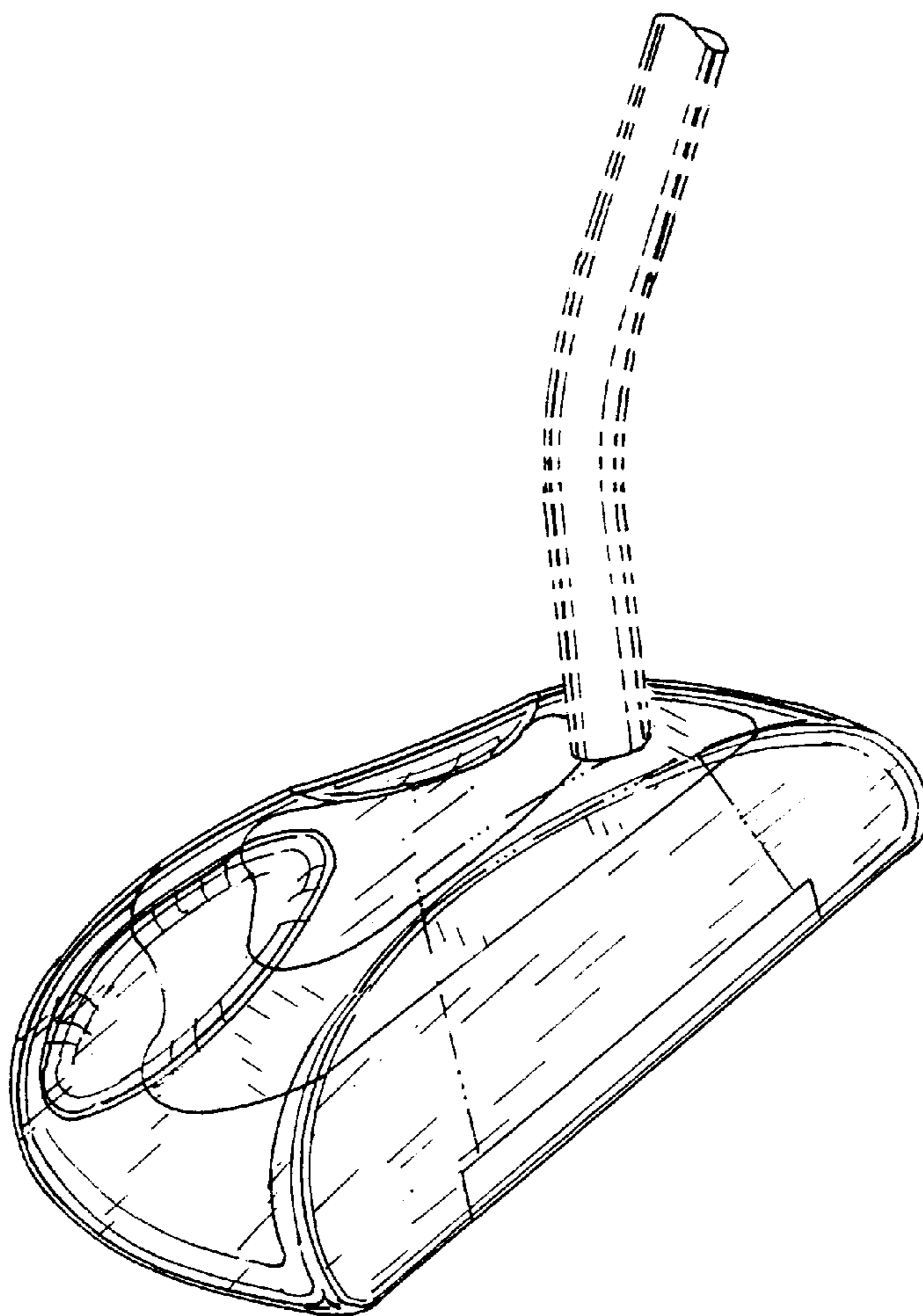

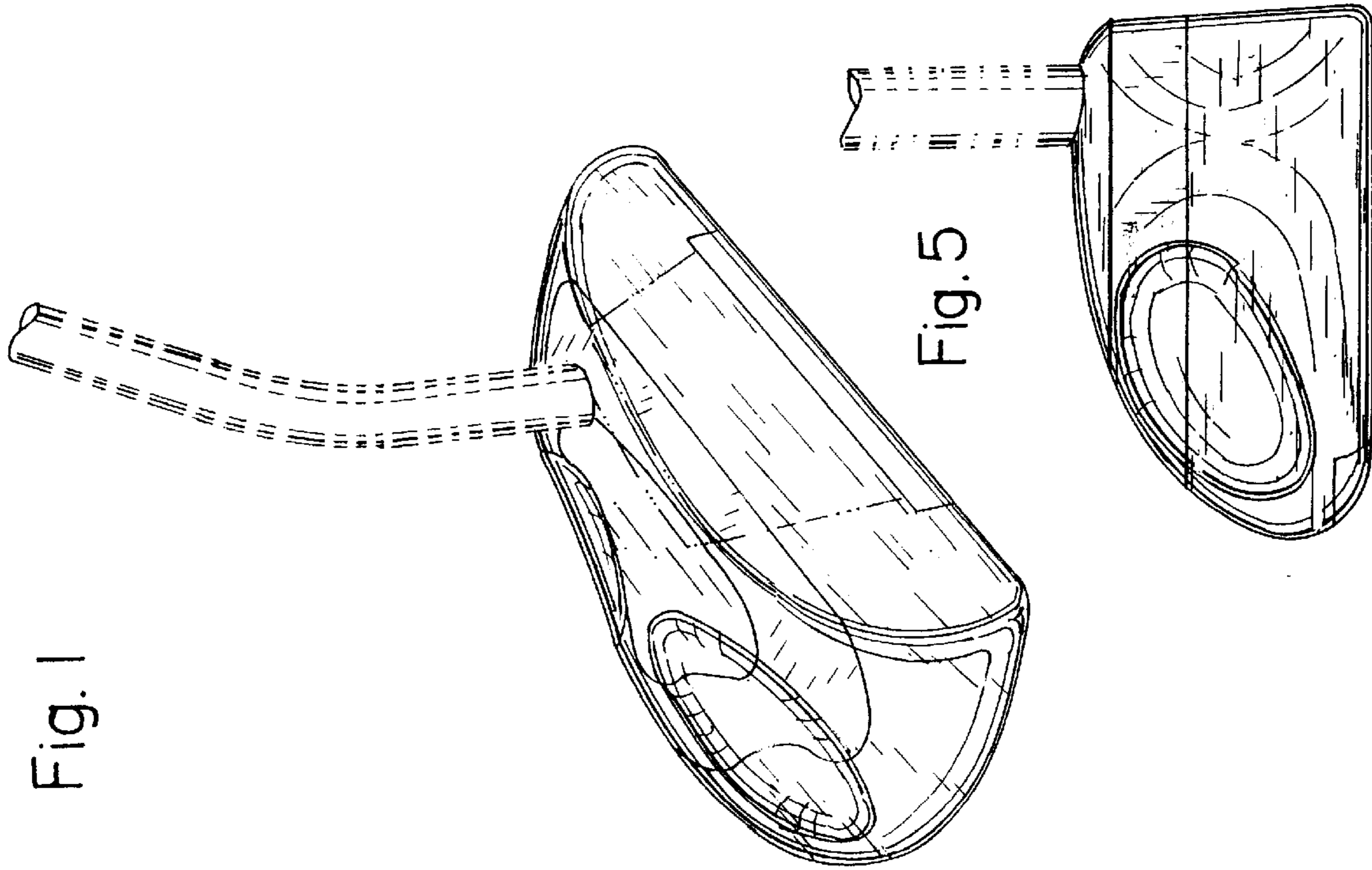

Fig. 1

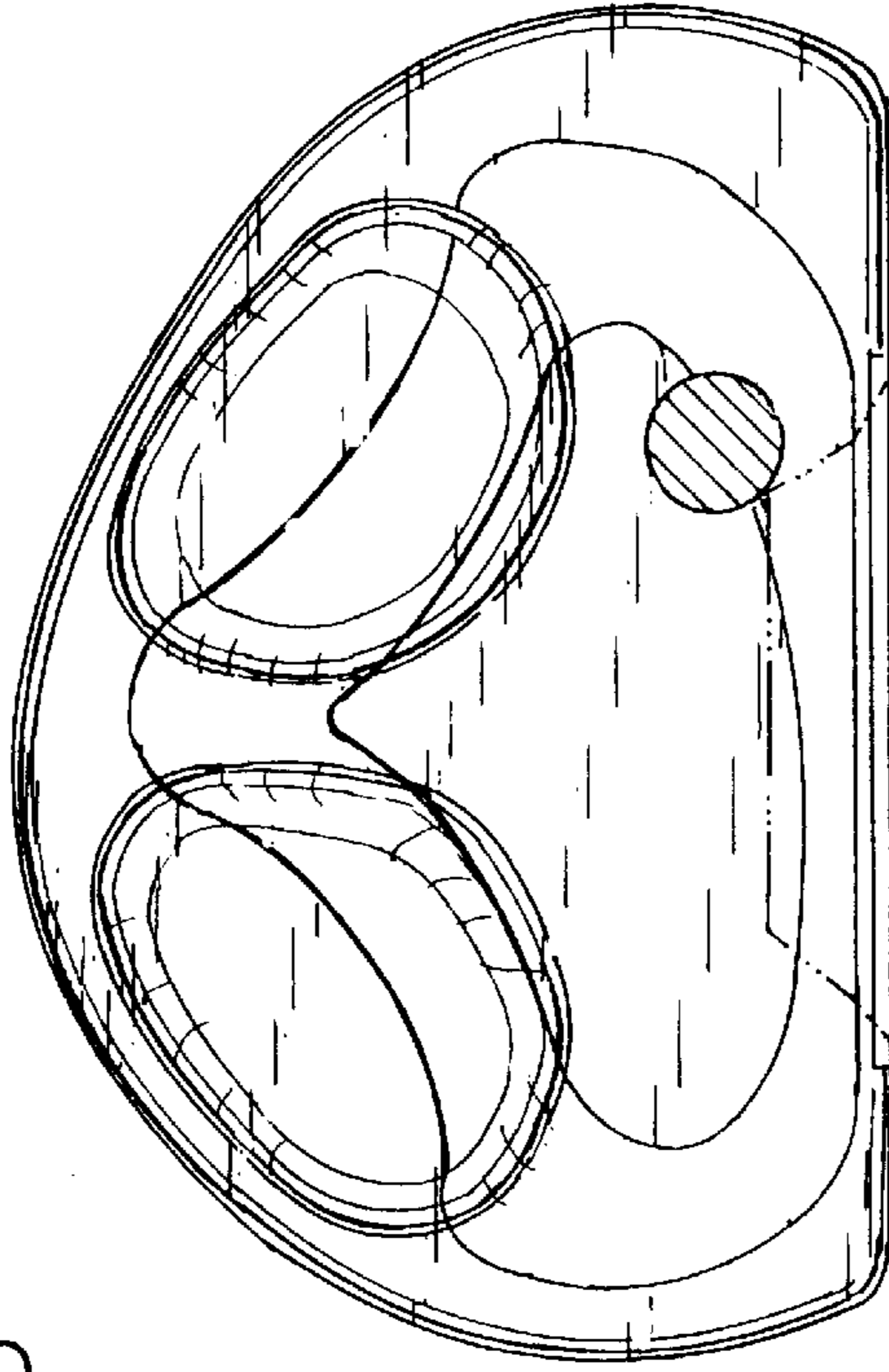

Fig. 3

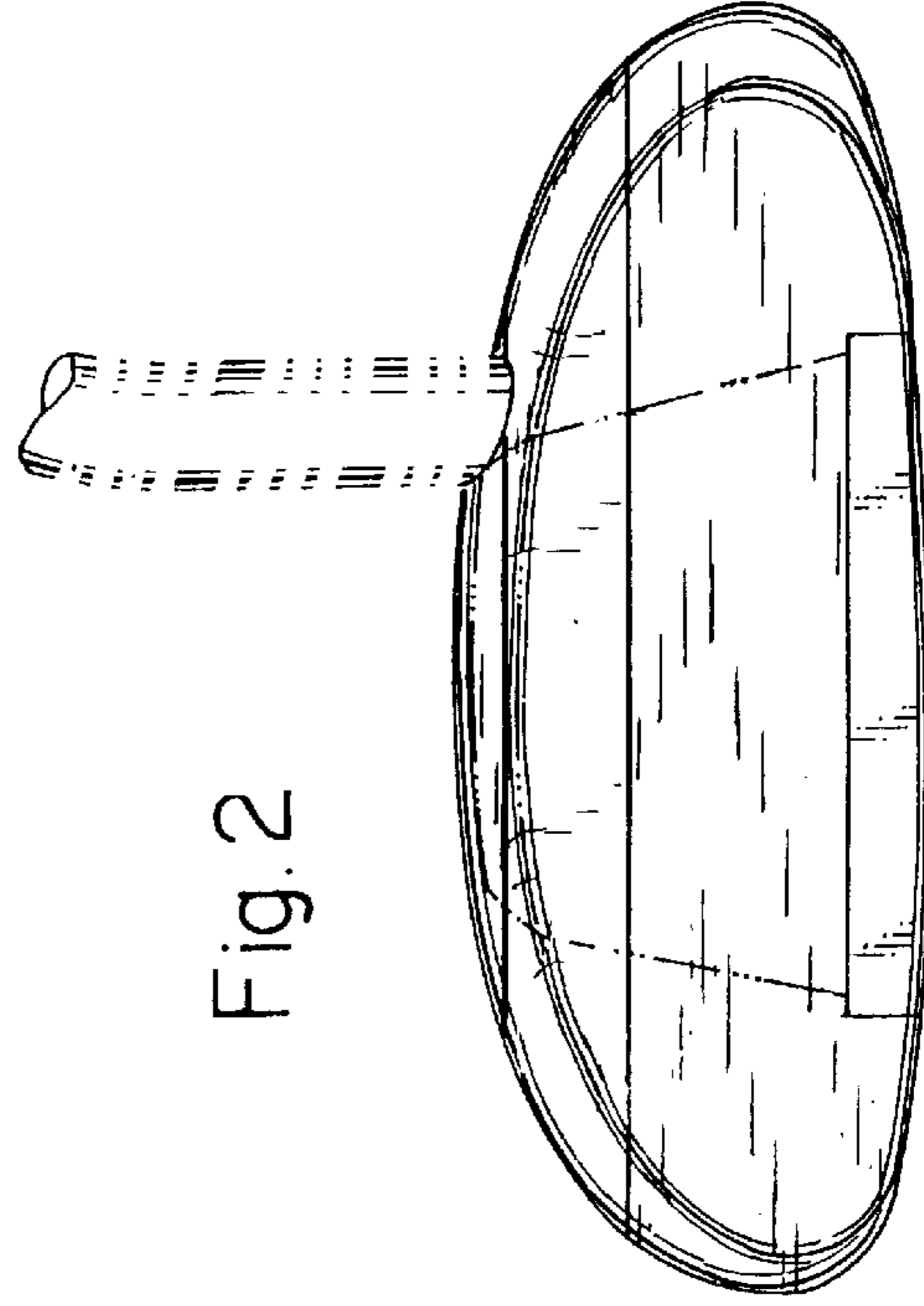

Fig. 2

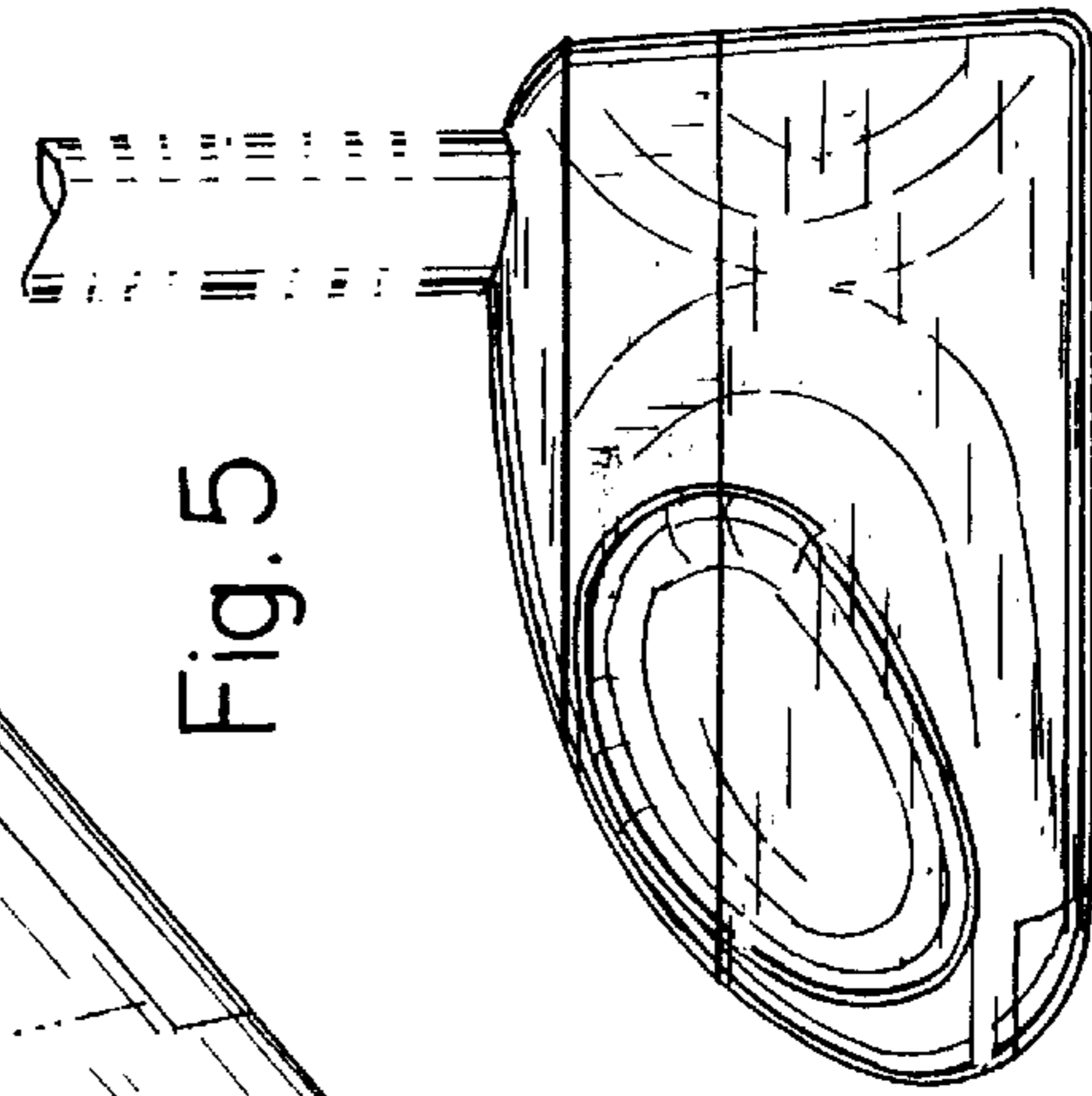

Fig. 5

Fig. 7

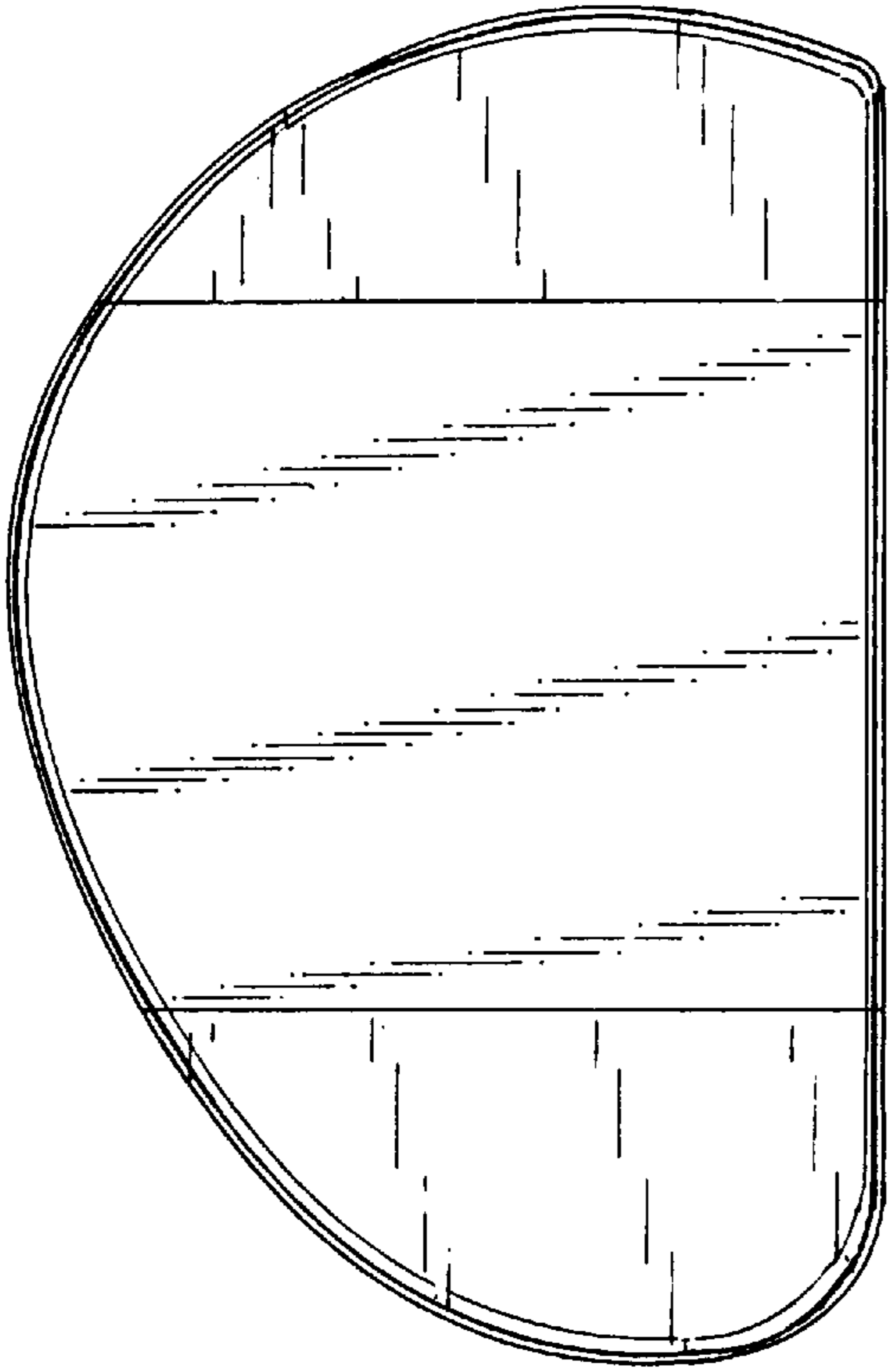

Fig. 6

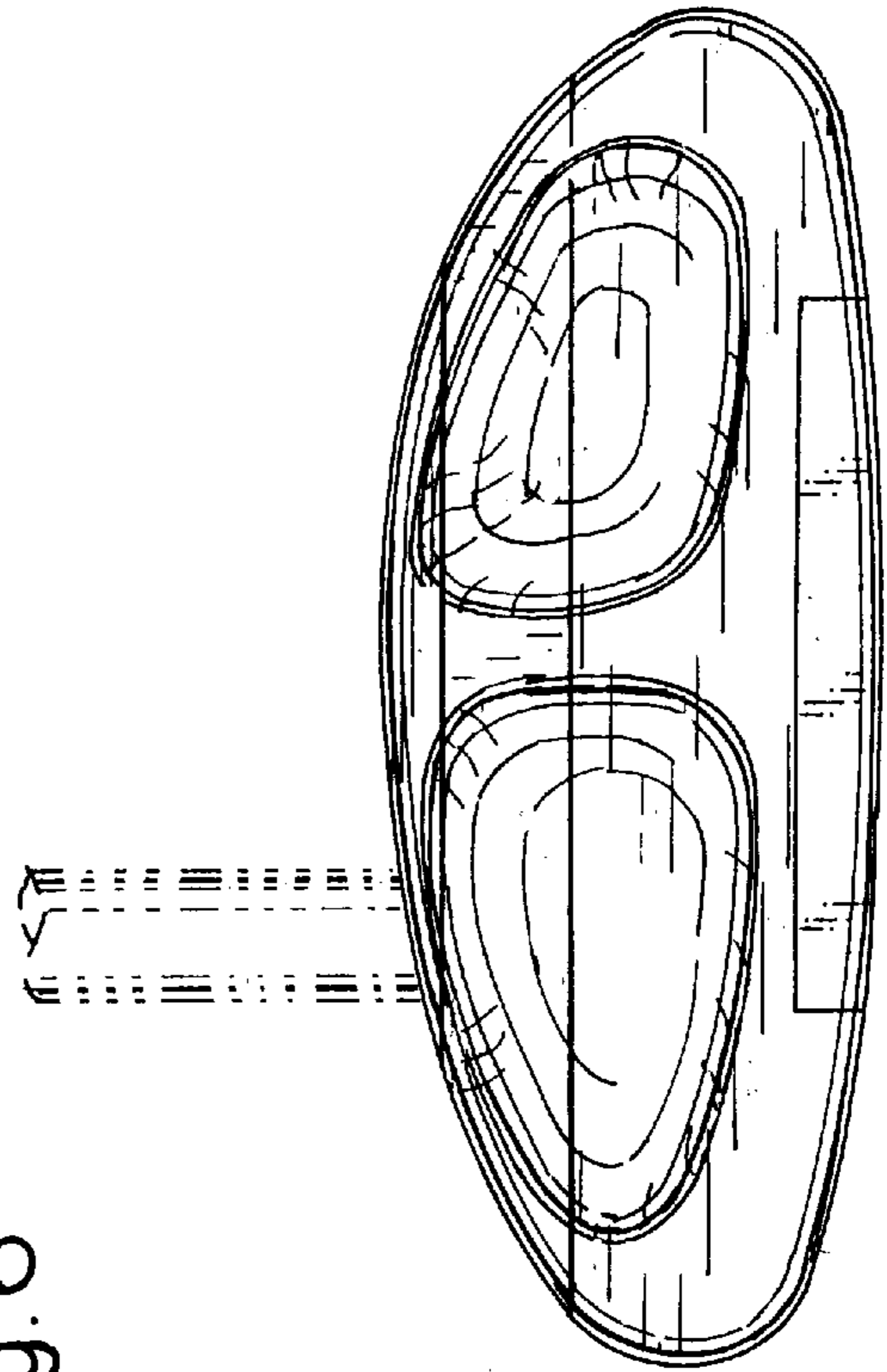

Fig. 4

