



US00D414203S

United States Patent [19]
Stukenkemper

[11] **Patent Number: Des. 414,203**

[45] **Date of Patent: ** Sep. 21, 1999**

[54] **FOUNTAIN PEN**

[75] Inventor: **Heinrich Stukenkemper,**
Castrop-Rauxel, Germany

[73] Assignee: **Rotring International GmbH & Co.**
KG, Hamburg, Germany

[**] Term: **14 Years**

[21] Appl. No.: **29/091,478**

[22] Filed: **Jul. 30, 1998**

[30] **Foreign Application Priority Data**

Jan. 30, 1998 [DE] Germany M 98 00 814

[51] **LOC (6) Cl.** **19-06**

[52] **U.S. Cl.** **D19/48; D19/43; D19/51;**
D19/56; D19/57

[58] **Field of Search** **D19/35, 36, 41-51,**
D19/53-58, 81-85; 401/196, 202, 6, 7,
88, 221, 222, 243-247, 262

[56] **References Cited**

U.S. PATENT DOCUMENTS

D. 162,805	4/1951	Ferber	D19/48
D. 328,919	8/1992	Bulgari	D19/43 X
D. 339,606	9/1993	Podobrin	D19/43
D. 350,771	9/1994	Kettmeir	D19/51
D. 396,058	7/1998	Schmidt et al.	D19/55 X
D. 400,580	11/1998	Schmidt et al.	D19/48
D. 404,426	1/1999	Takanashi	D19/43
D. 404,764	1/1999	Perry et al.	D19/48

Primary Examiner—Martie K. Holtje

Attorney, Agent, or Firm—Fitzpatrick, Cella, Harper & Scinto

[57] **CLAIM**

I claim the ornamental design for a fountain pen, as shown and described.

DESCRIPTION

FIG. 1 is a front elevational view of a first embodiment of a fountain pen showing my new design in an exploded condition;

FIG. 2 is a front elevational view of a second embodiment of my design of FIG. 1 shown in an exploded condition; FIG. 3 is a front elevational view of a third embodiment of my design of FIG. 1 shown in an exploded condition; FIG. 4 is a rear elevation view of FIG. 1; FIG. 5 is a rear elevation view of FIG. 2; FIG. 6 is a rear elevation view of FIG. 3; FIG. 7 is a right side elevation view of FIG. 1; FIG. 8 is a right side elevation view of FIG. 2; FIG. 9 is a right side elevation view of FIG. 3; FIG. 10 is a left side elevation view of FIG. 1; FIG. 11 is a left side elevation view of FIG. 2; FIG. 12 is a left side elevation view of FIG. 3; FIG. 13 is a top plan view of the cap member of FIG. 1; FIG. 14 is a top plan view of the cap member of FIG. 2; FIG. 15 is a top plan view of the cap member of FIG. 3; FIG. 16 is a bottom plan view of FIG. 1, showing the end part; FIG. 17 is a bottom plan view of FIG. 2, showing the end part; FIG. 18 is a bottom plan view of FIG. 3, showing the end part; FIG. 19 is a front plan view of FIG. 1, showing the writing tip; FIG. 20 is a front plan view of FIG. 2, showing the writing tip; FIG. 21 is a front plan view of FIG. 3, showing the writing tip; FIG. 22 is a bottom plan view of the cap member of FIG. 1, with the pen body removed for convenience of illustration; FIG. 23 is a bottom plan view of the cap member of FIG. 2, with the pen body removed for convenience of illustration; FIG. 24 is a bottom plan view of the cap member of FIG. 3, with the pen body removed for convenience of illustration; FIG. 25 is a front elevational view of a fourth embodiment of my design of FIG. 1 shown in an exploded condition; FIG. 26 is a front elevational view of a fifth embodiment of my design of FIG. 1 shown in an exploded condition; FIG. 27 is a front elevational view of a sixth embodiment of my design of FIG. 1 shown in an exploded condition; FIG. 28 is a rear elevation view of FIG. 25; FIG. 29 is a rear elevation view of FIG. 26; FIG. 30 is a rear elevation view of FIG. 27; FIG. 31 is a left side elevation view of FIG. 25; FIG. 32 is a left side elevation view of FIG. 26; FIG. 33 is a left side elevation view of FIG. 27;

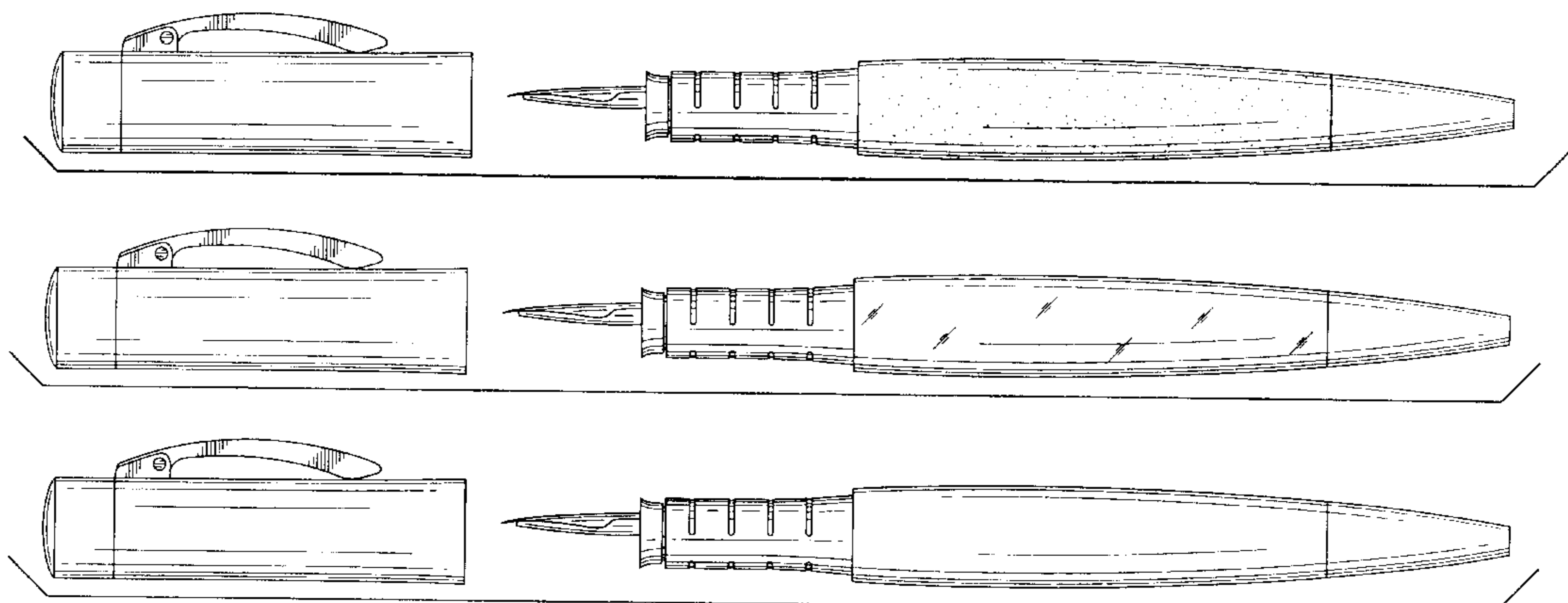

FIG. 34 is a right side elevation view of FIG. 25;
FIG. 35 is a right side elevation view of FIG. 26;
FIG. 36 is a right side elevation view of FIG. 27;
FIG. 37 is a top plan view of the cap member of FIG. 25;
FIG. 38 is a top plan view of the cap member of FIG. 26;
FIG. 39 is a top plan view of the cap member of FIG. 27;
FIG. 40 is a bottom plan view of FIG. 25, showing the end part;
FIG. 41 is a bottom plan view of FIG. 26, showing the end part;
FIG. 42 is a bottom plan view of FIG. 27, showing the end part;
FIG. 43 is a front plan view of FIG. 25, showing the writing tip;

FIG. 44 is a front plan view of FIG. 26, showing the writing tip;
FIG. 45 is a front plan view of FIG. 27, showing the writing tip;
FIG. 46 is a bottom plan view of the cap member of FIG. 25, with the pen body removed for convenience of illustration;
FIG. 47 is a bottom plan view of the cap member of FIG. 26, with the pen body removed for convenience of illustration; and,
FIG. 48 is a bottom plan view of the cap member of FIG. 27, with the pen body removed for convenience of illustration.

1 Claim, 10 Drawing Sheets

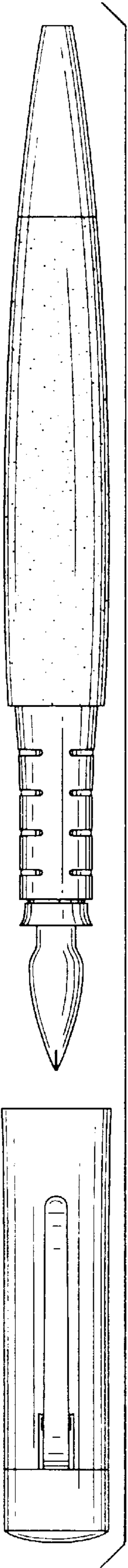

FIG. 1

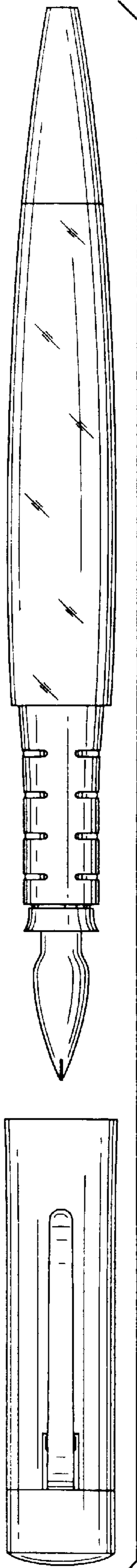

FIG. 2

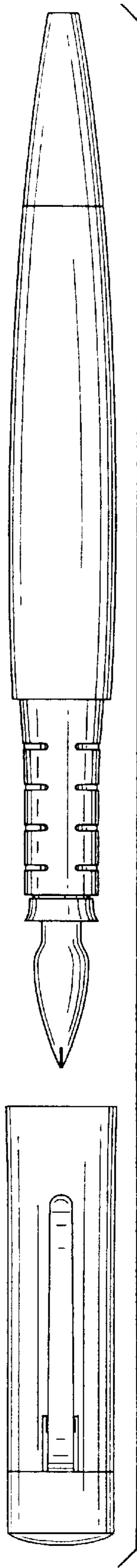

FIG. 3

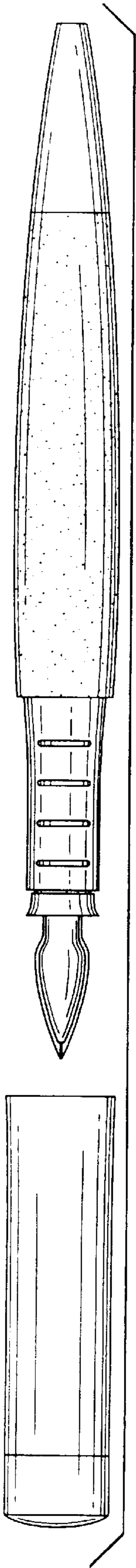

FIG. 4

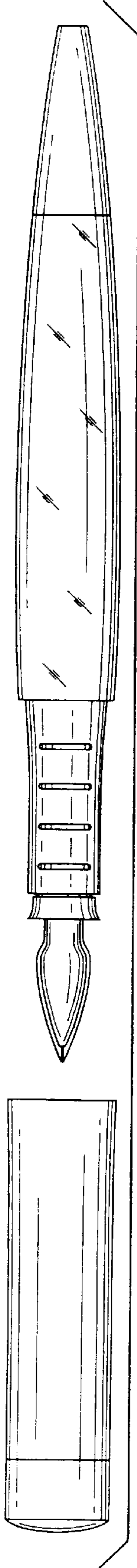

FIG. 5

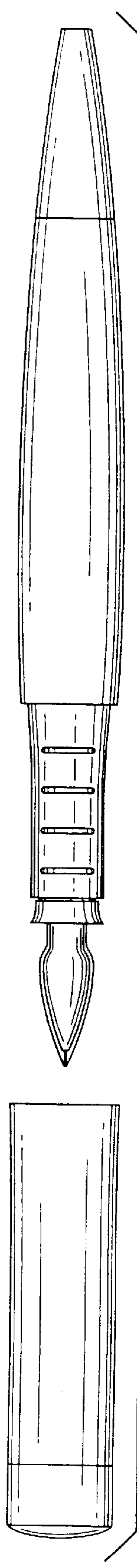

FIG. 6

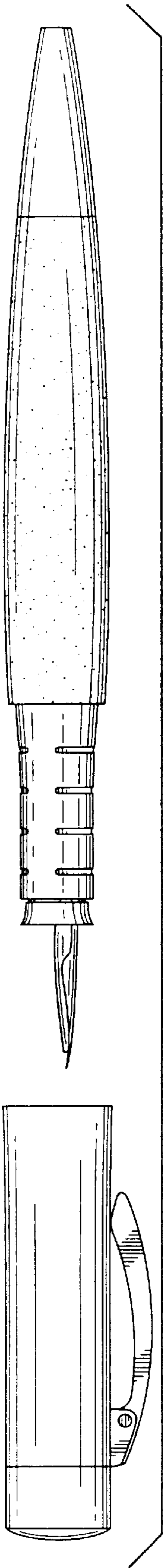

FIG. 7

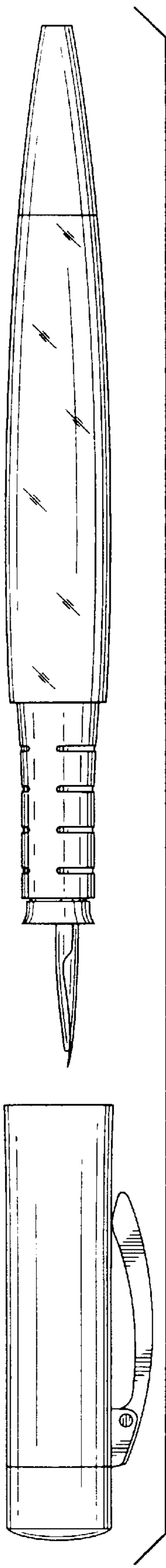

FIG. 8

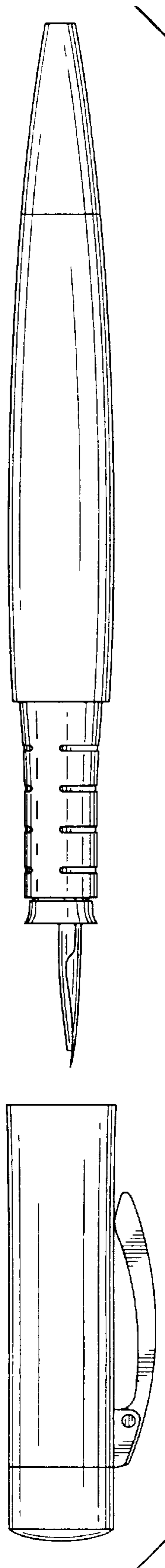

FIG. 9

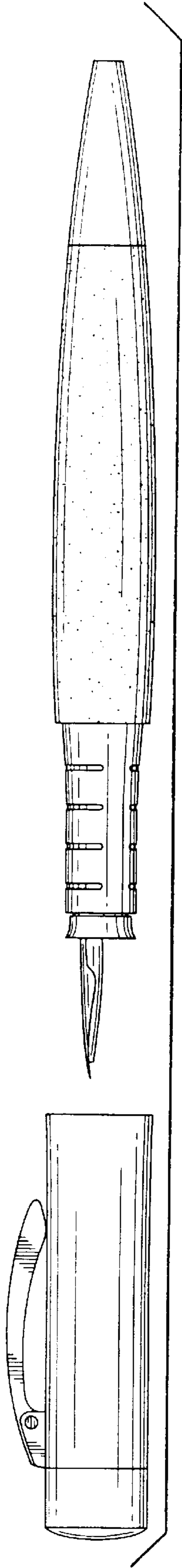

FIG. 10

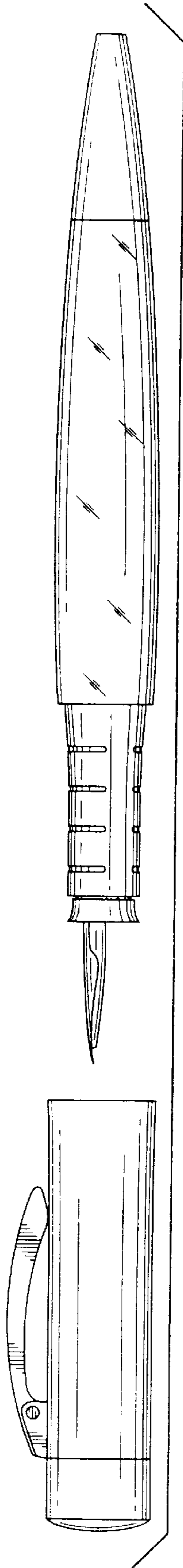

FIG. 11

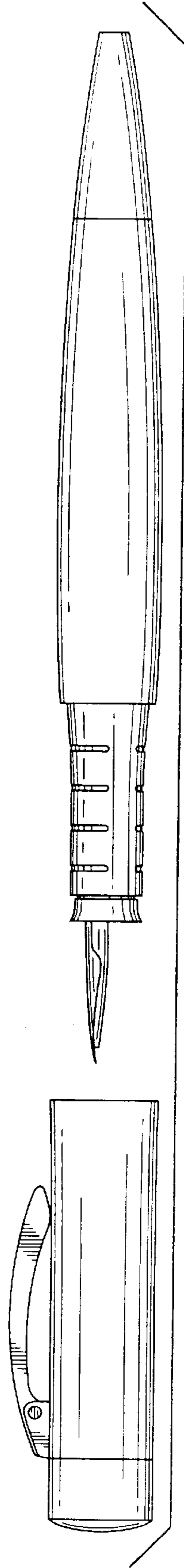

FIG. 12

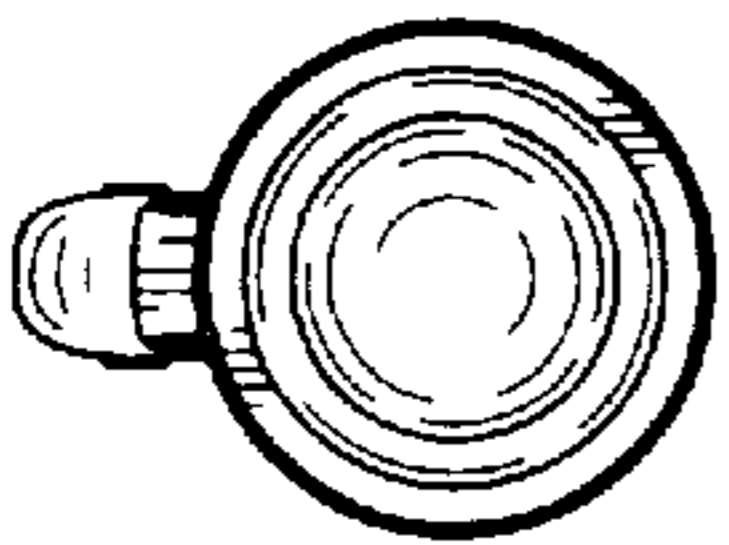

FIG. 13

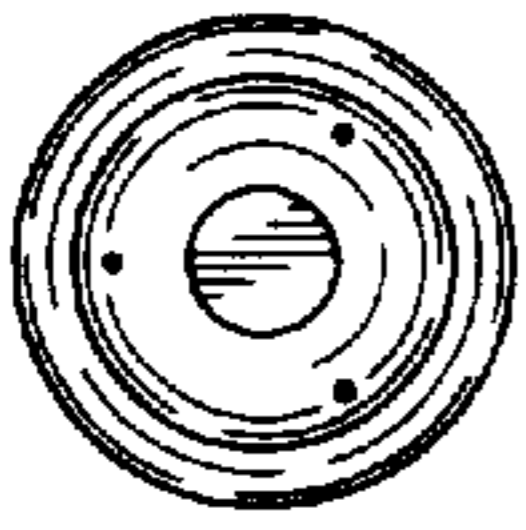

FIG. 16



FIG. 19

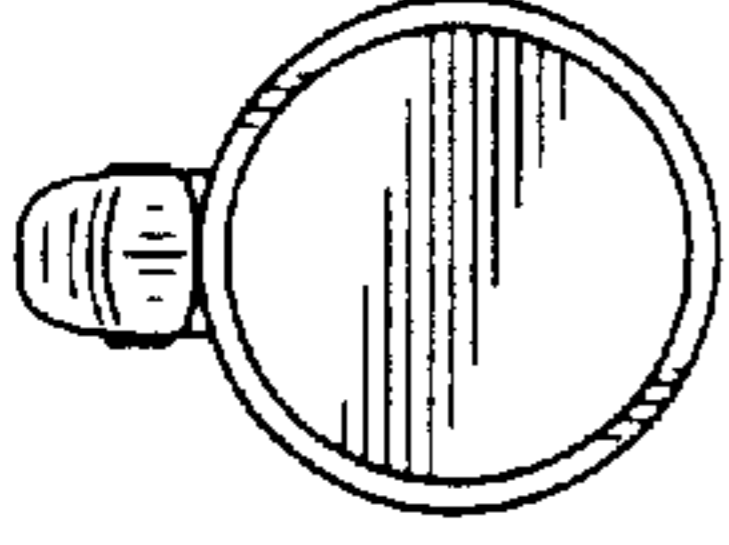

FIG. 22

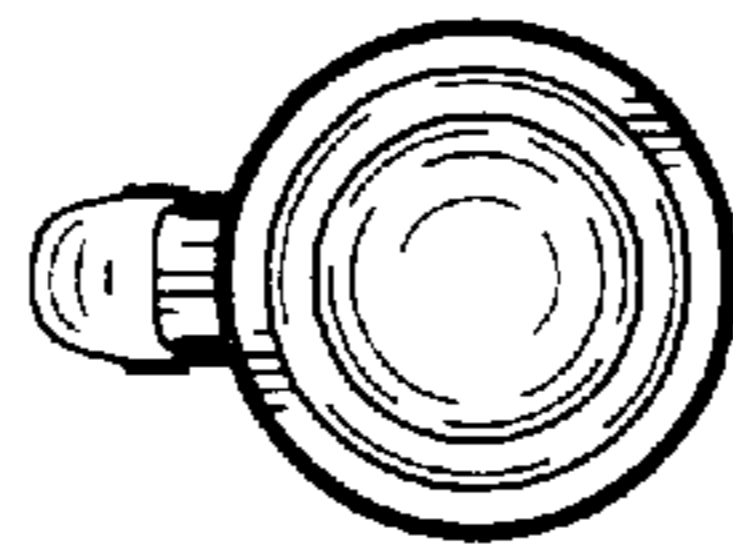

FIG. 14

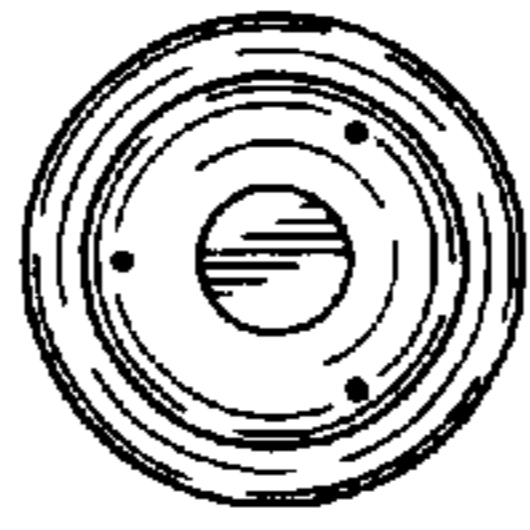

FIG. 17



FIG. 20

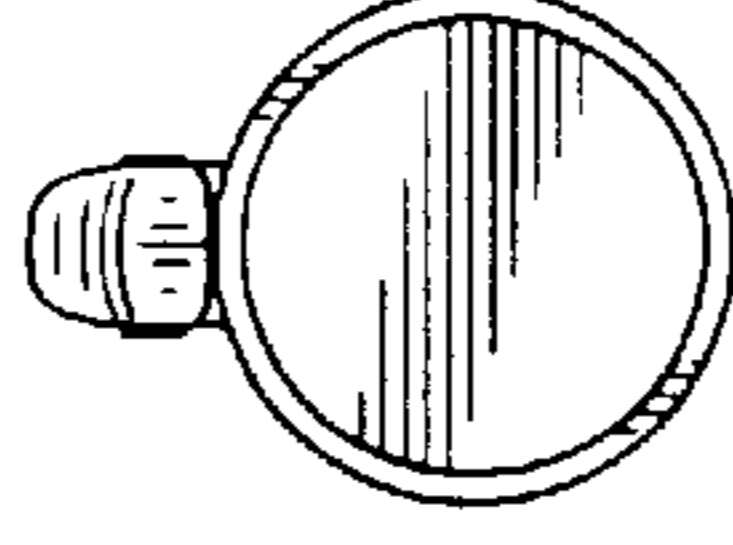

FIG. 23

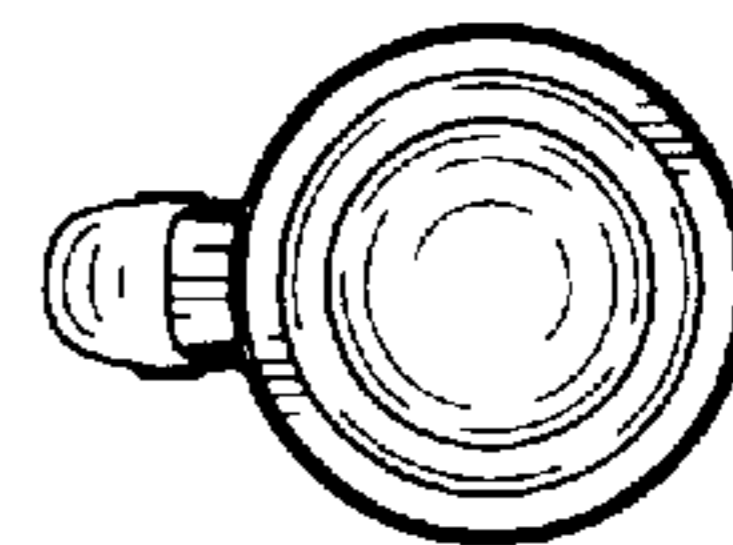

FIG. 15

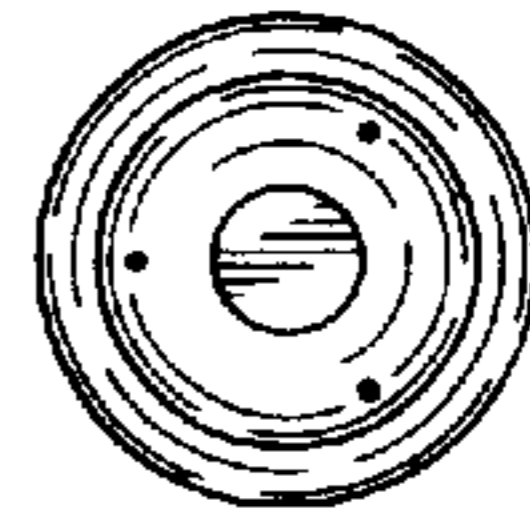

FIG. 18



FIG. 21

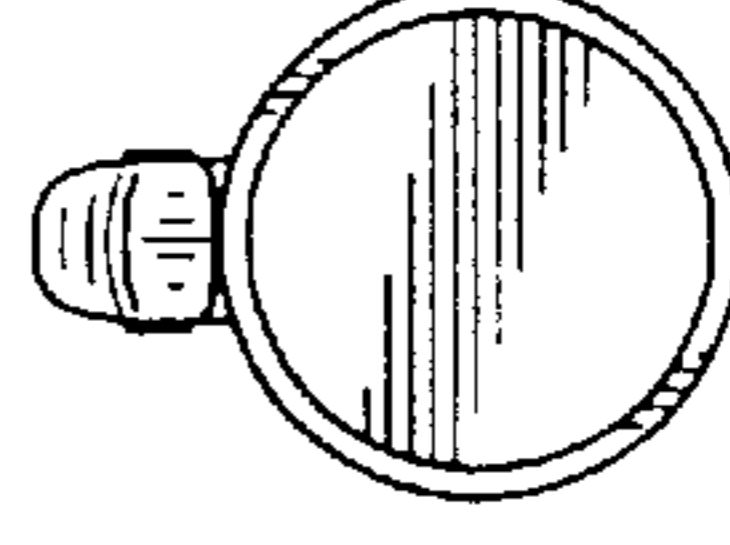

FIG. 24

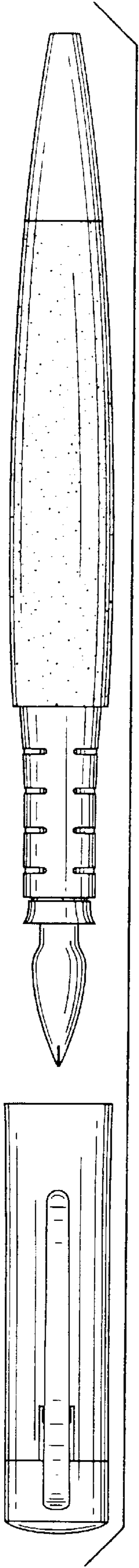

FIG. 25

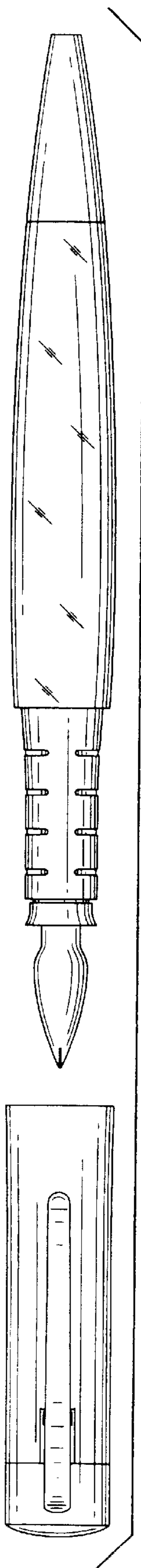

FIG. 26

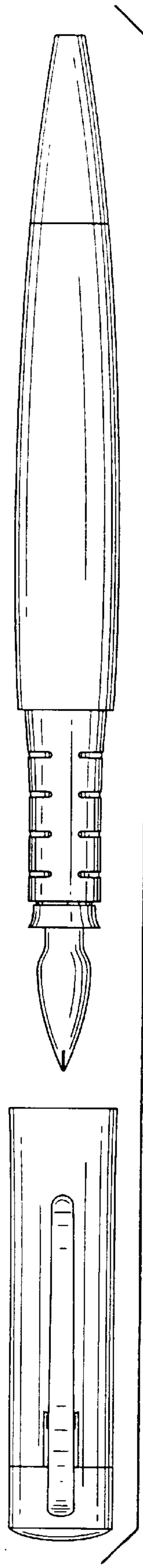

FIG. 27

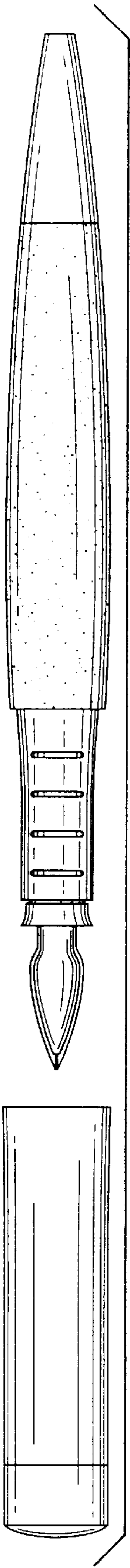

FIG. 28

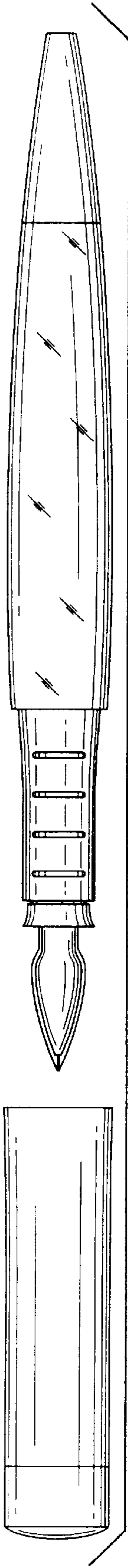

FIG. 29

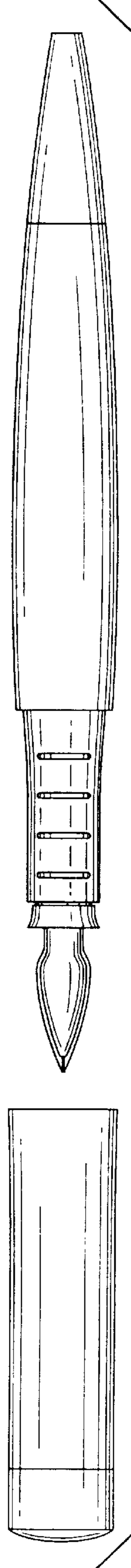

FIG. 30

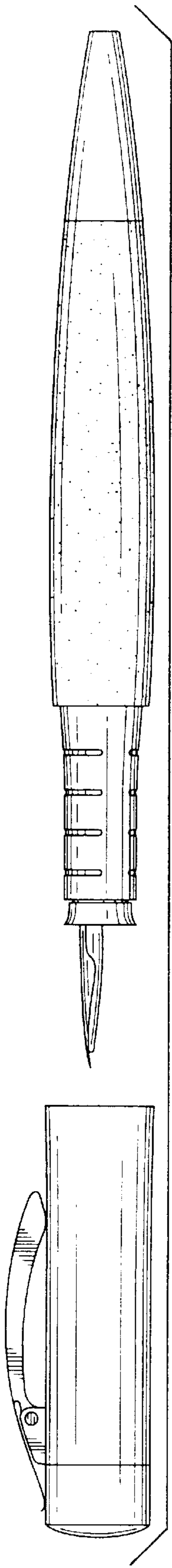

FIG. 31

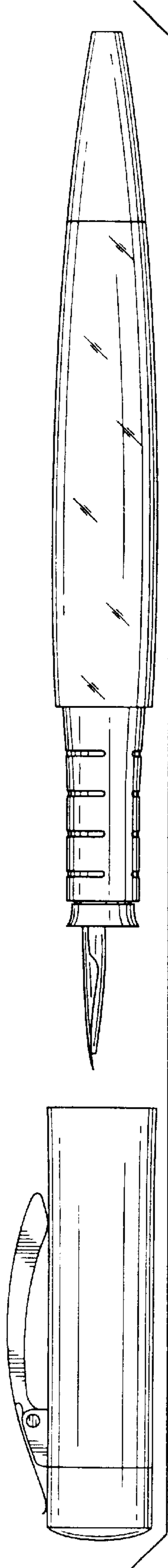

FIG. 32

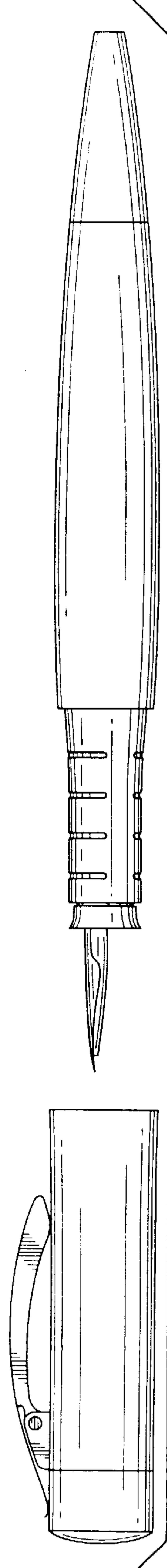

FIG. 33

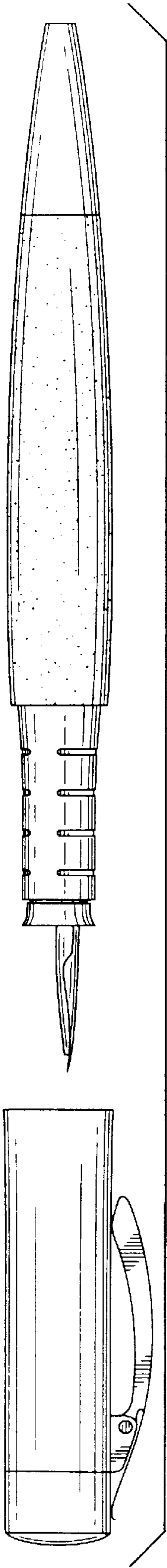

FIG. 34

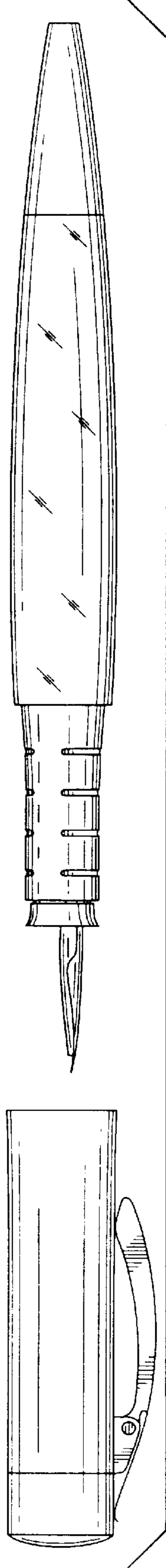

FIG. 35

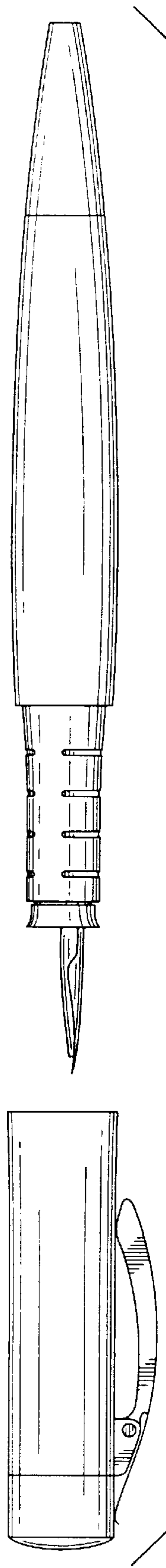

FIG. 36

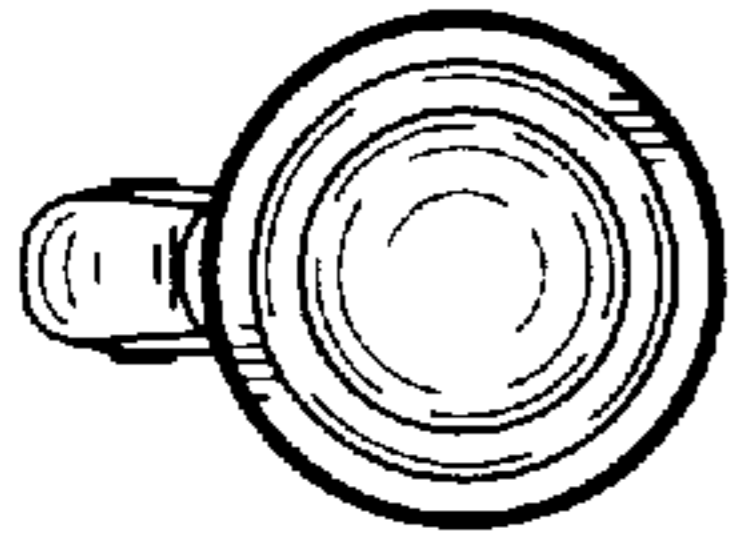

FIG. 37

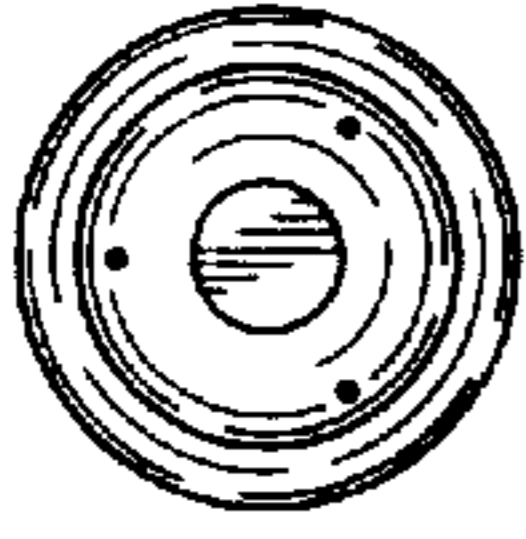

FIG. 40



FIG. 43

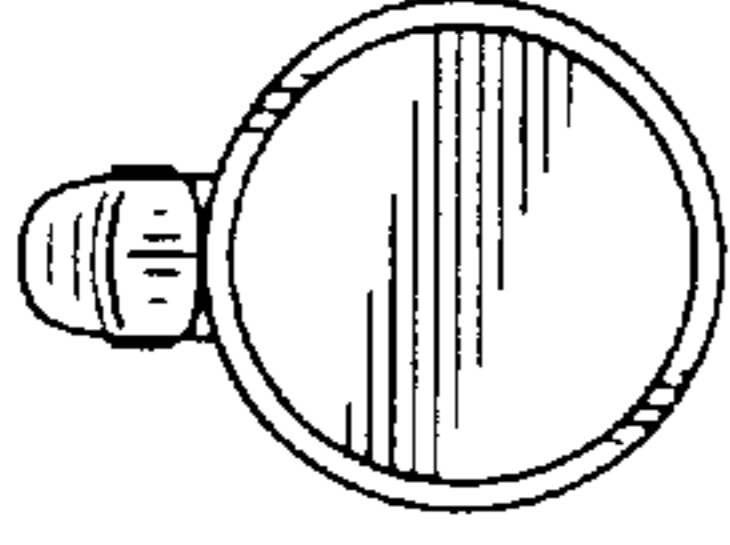

FIG. 46

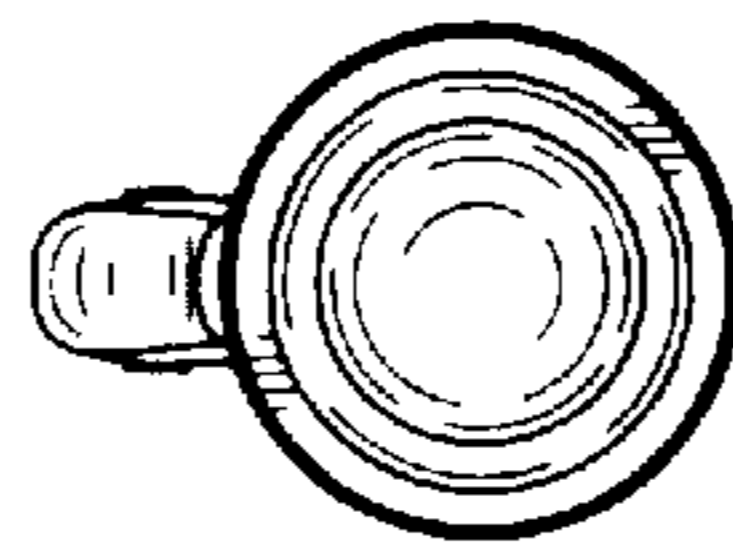

FIG. 38

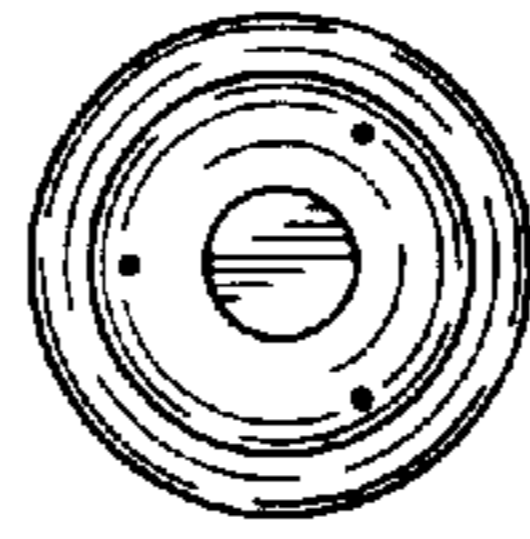

FIG. 41



FIG. 44

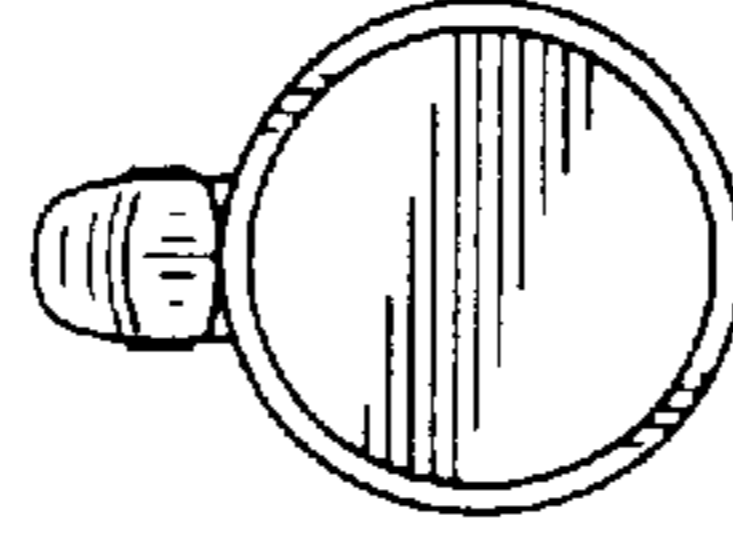

FIG. 47

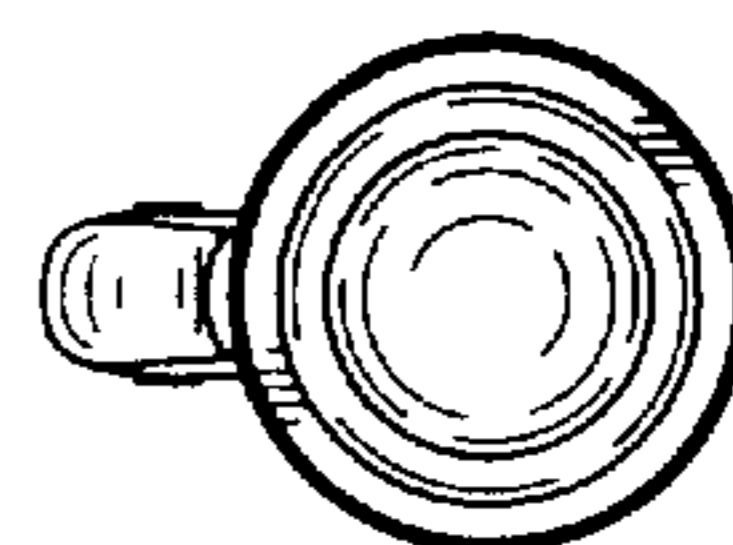

FIG. 39

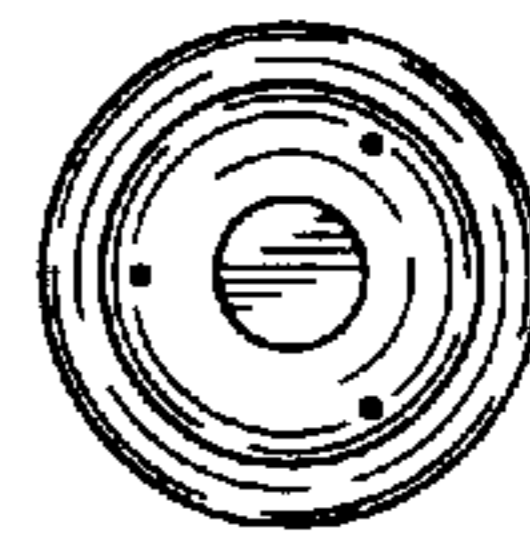

FIG. 42

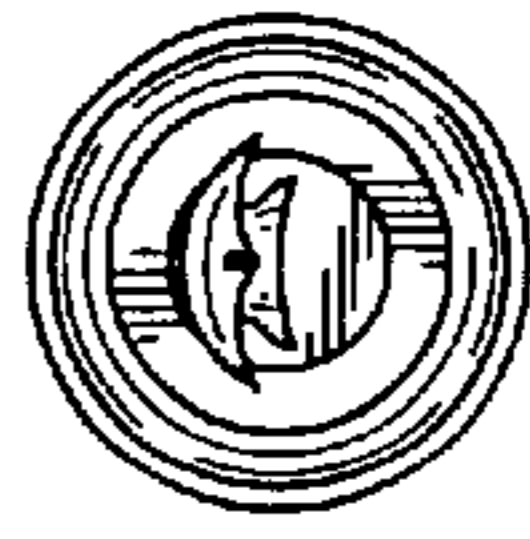

FIG. 45

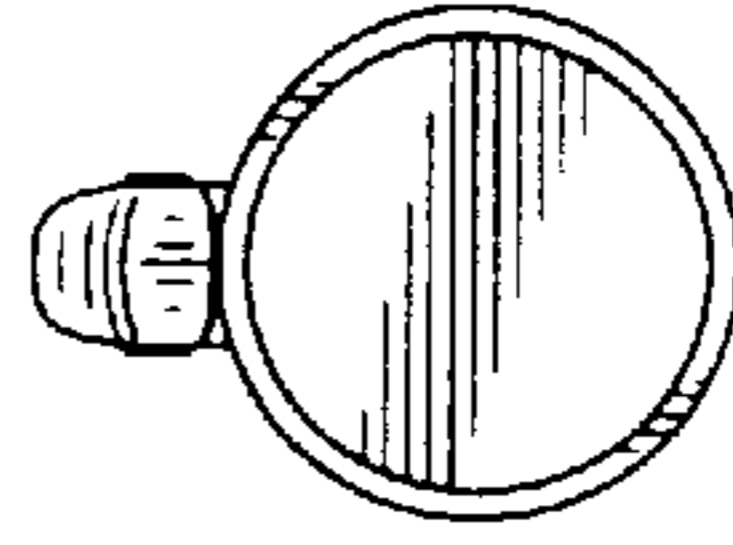

FIG. 48