



US00D414180S

United States Patent [19]
Waldner

[11] **Patent Number: Des. 414,180**

[45] **Date of Patent: ** Sep. 21, 1999**

[54] **CHARGING STATION FOR PORTABLE TELEPHONE**

[75] Inventor: **Thomas Waldner**, Malmö, Sweden

[73] Assignee: **Ericsson Business Mobile Networks B.V.**, Amsterdam, Netherlands

[**] Term: **14 Years**

[21] Appl. No.: **29/059,262**

[22] Filed: **Sep. 6, 1996**

[30] **Foreign Application Priority Data**

Mar. 6, 1996 [XH] Hague Agreement DM/035776

[51] **LOC (6) Cl.** **14-03**

[52] **U.S. Cl.** **D14/149; D13/108; D14/253**

[58] **Field of Search** D14/140, 142, D14/149, 150, 147, 148, 251, 252, 253, 240; D13/107, 108; 379/454, 455, 446, 434, 435, 436; 320/2-5

[56] **References Cited**

U.S. PATENT DOCUMENTS

D. 206,590 1/1967 Haggstrom et al. D13/108

D. 313,221	12/1990	Skully et al.	D13/108
D. 322,061	12/1991	Watanabe	D13/108
D. 323,504	1/1992	Langton	D14/142
D. 344,708	3/1994	Ho	D13/108
D. 346,786	5/1994	Nagele et al.	D14/149 X
D. 353,371	12/1994	Delhaes	D14/149
D. 363,284	10/1995	Solomita	D14/253 X
5,052,943	10/1991	Davis	320/2 X
5,463,688	10/1995	Wijas	379/446

Primary Examiner—Jeffrey Asch

Attorney, Agent, or Firm—Christie, Parker & Hale, LLP

[57] **CLAIM**

The ornamental design for charging station for portable telephone, as shown and described.

DESCRIPTION

FIG. 1 is front right side perspective view of my new design; FIG. 2 is front elevation view thereof; FIG. 3 is bottom elevation view thereof; FIG. 4 is top elevation view thereof; FIG. 5 is rear elevation view thereof; FIG. 6 is right side elevation view thereof; and, FIG. 7 is left side elevation view thereof.

1 Claim, 7 Drawing Sheets

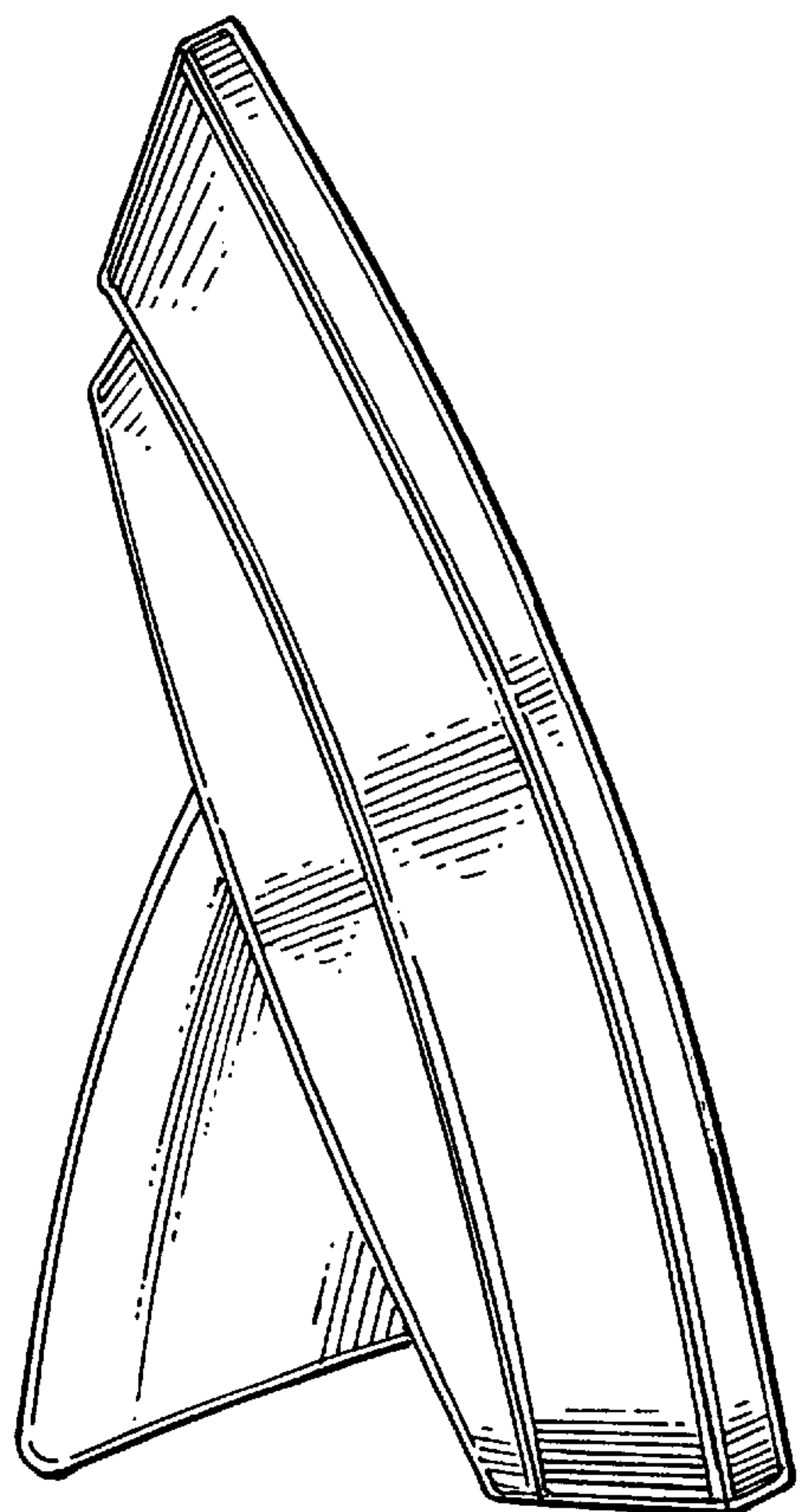
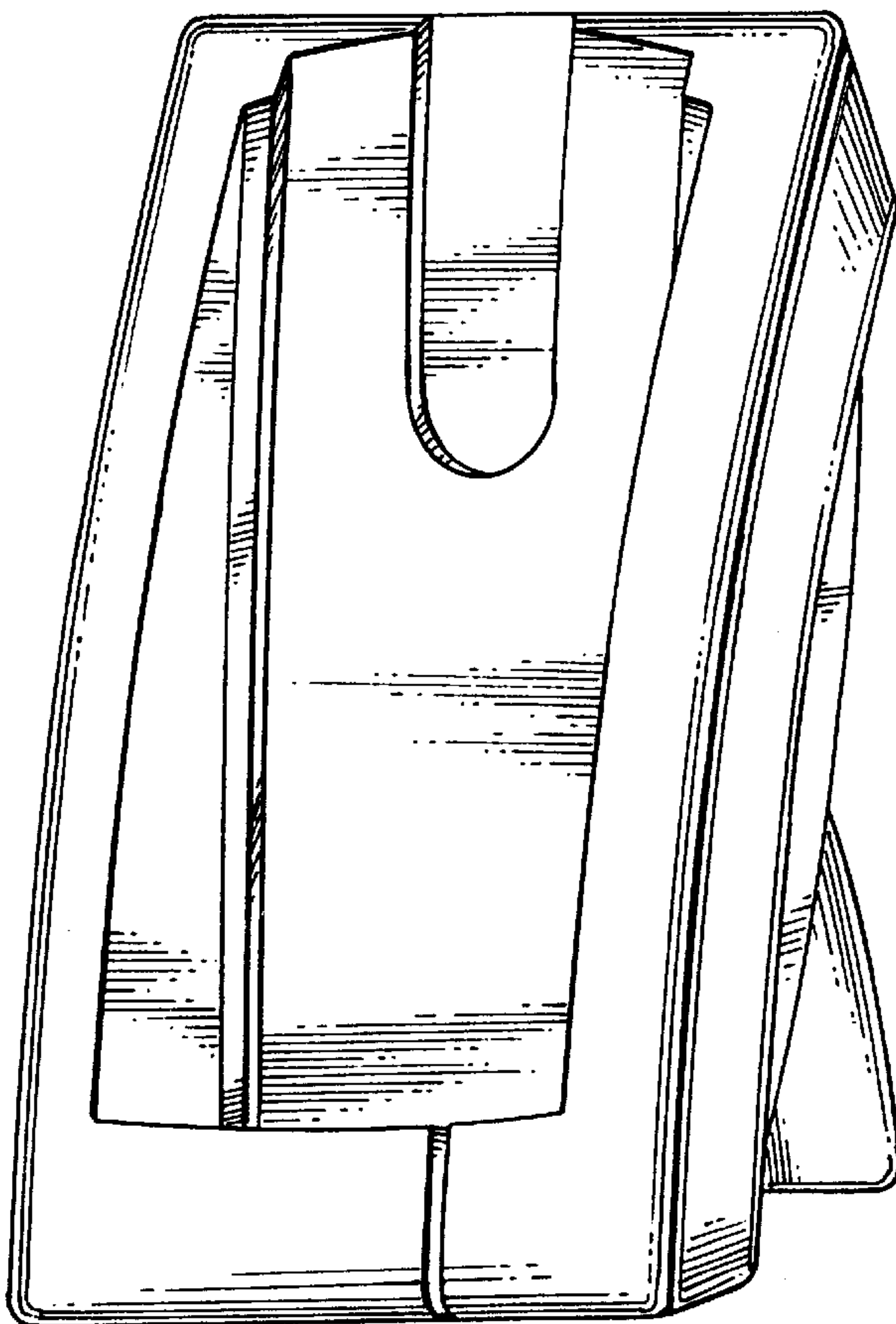

Fig. 1

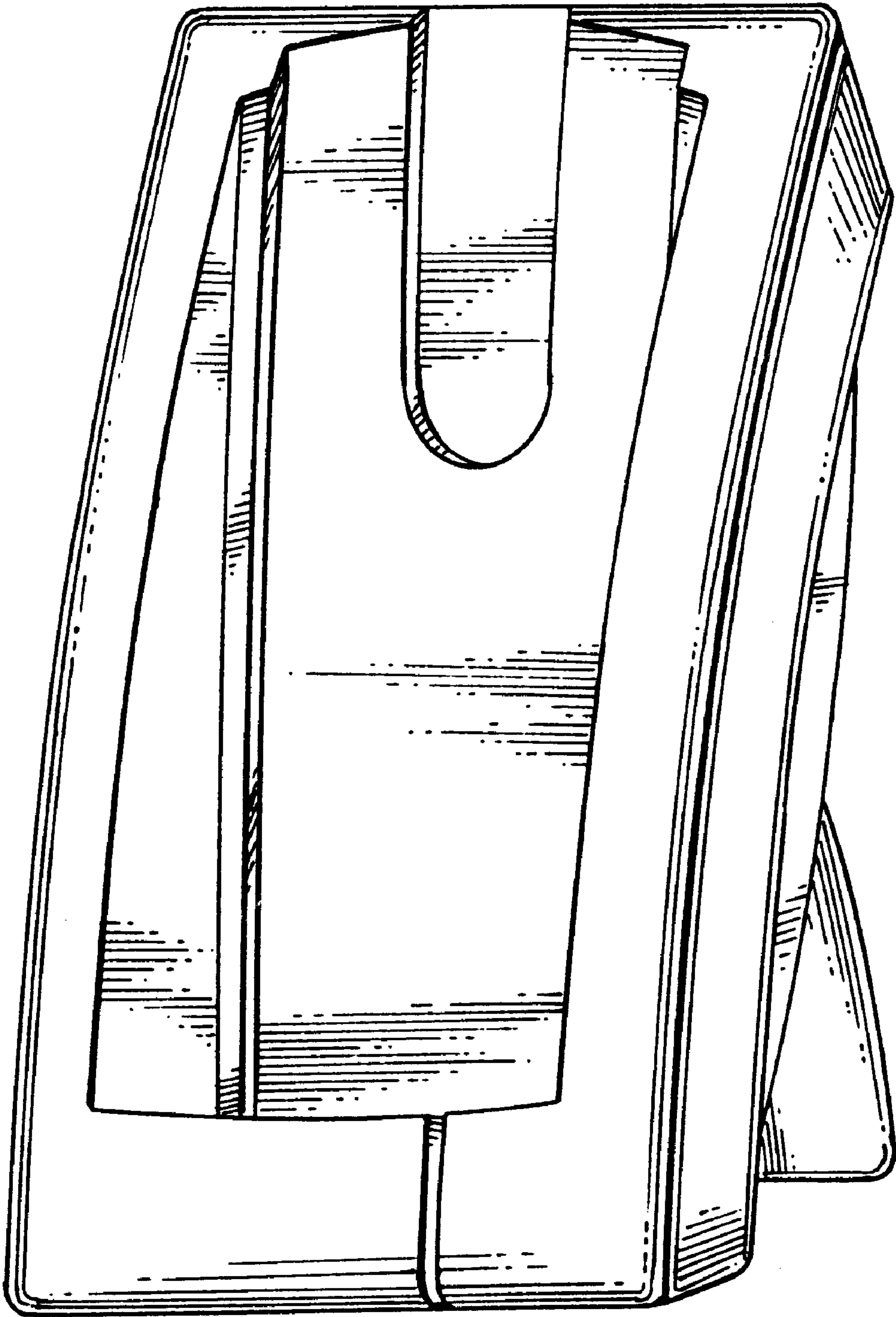

Fig. 2

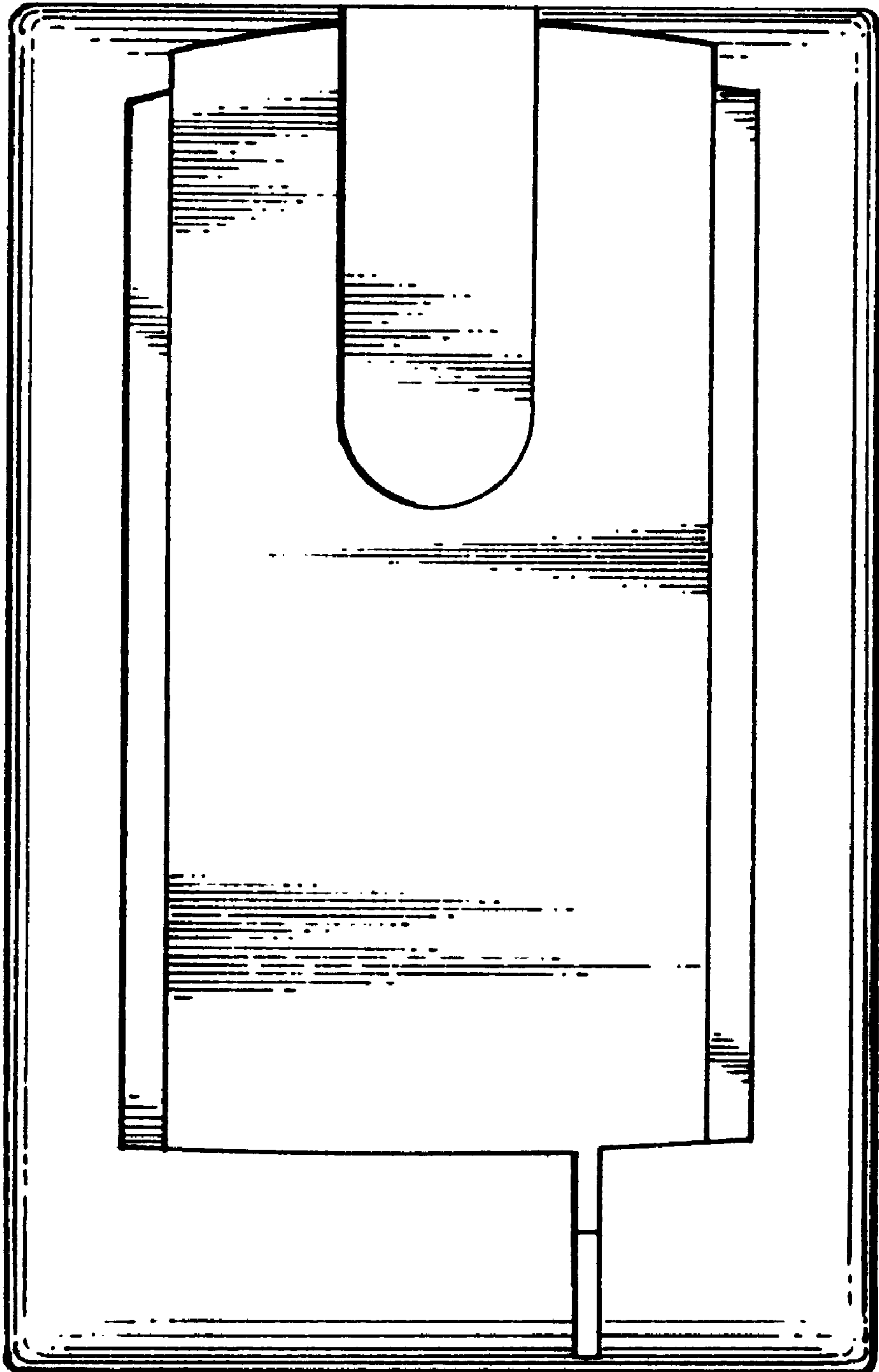

Fig. 3

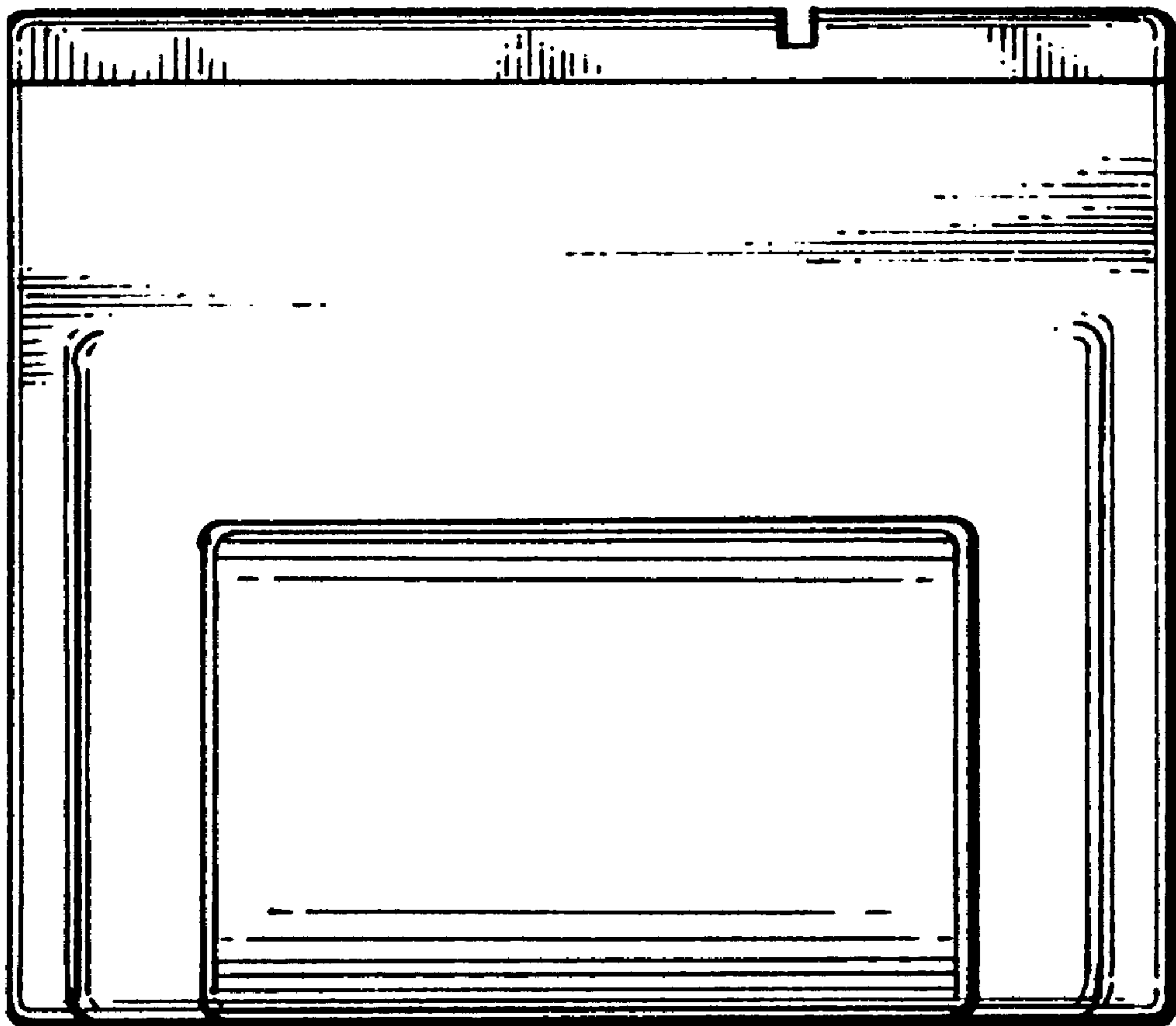

Fig. 4

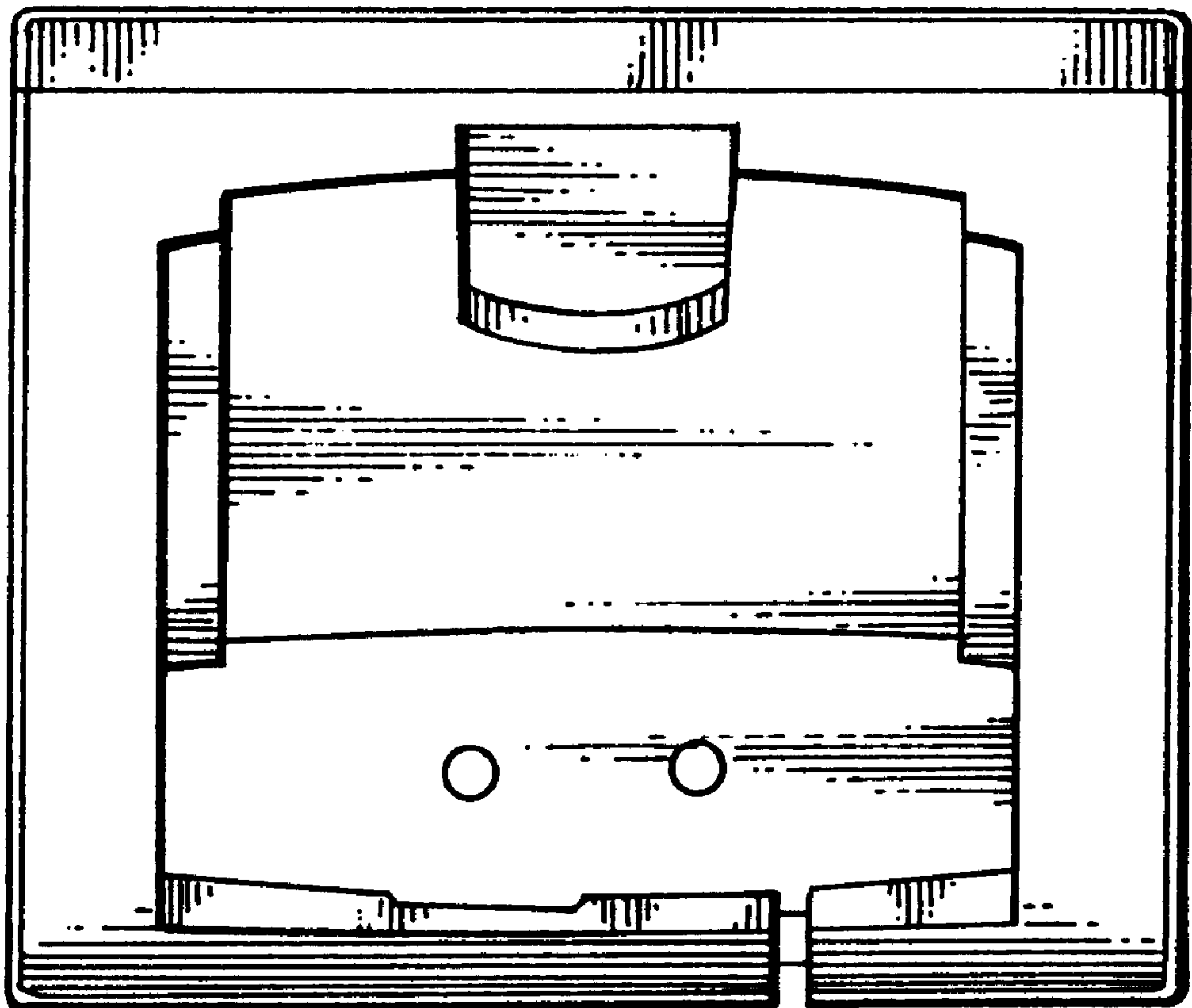

Fig. 5

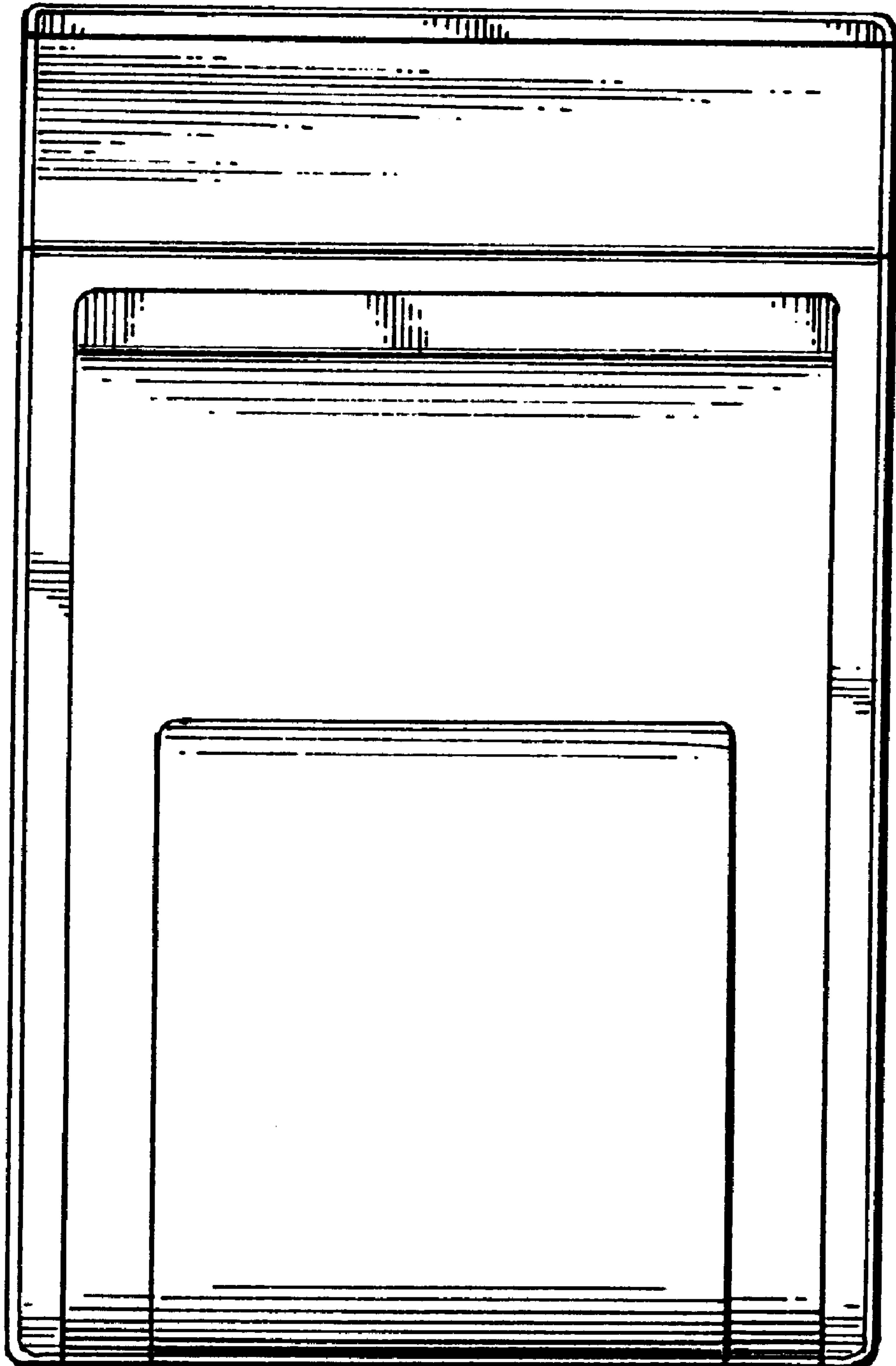

Fig. 6

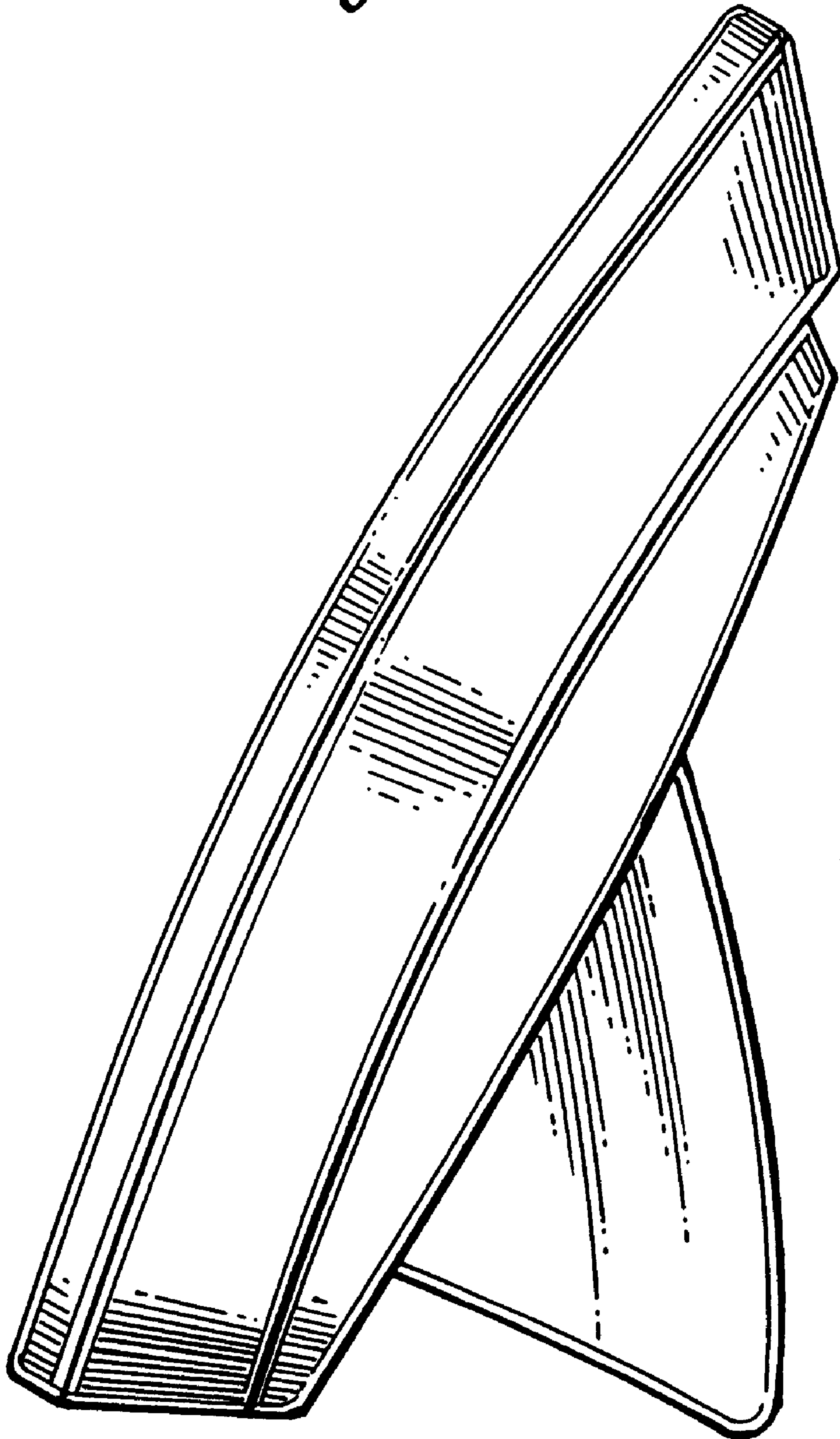

Fig. 7

