



US00D414165S

United States Patent [19] Klein

[11] **Patent Number: Des. 414,165**

[45] **Date of Patent: ** Sep. 21, 1999**

[54] **ATTACHMENT SUPPORT**

[75] Inventor: **Traugott Klein**, Herrenberg, Germany

[73] Assignee: **Hewlett-Packard Company**, Palo Alto, Calif.

[**] Term: **14 Years**

[21] Appl. No.: **29/079,682**

[22] Filed: **Nov. 20, 1997**

[30] **Foreign Application Priority Data**

Aug. 9, 1997 [DE] Germany M 97 07 809

[51] **LOC (6) Cl.** **08-05**

[52] **U.S. Cl.** **D14/114; D8/380**

[58] **Field of Search** D14/100, 107,
D14/114; D8/380-1, 349; 248/917-24,
207, 220.21, 225.21, 304, 317, 339

[56] **References Cited**

U.S. PATENT DOCUMENTS

- D. 347,380 5/1994 Herber D8/380
- D. 383,121 9/1997 Sebastian D14/114
- D. 391,243 2/1998 Rosen D14/114

- D. 391,937 3/1998 Rosen D14/114
- D. 391,945 3/1998 Rosen D14/114
- D. 395,874 7/1998 Rosen D14/114
- 5,803,422 9/1998 Buchler 248/339

Primary Examiner—M. H. Tung

[57] **CLAIM**

I claim the ornamental design for an attachment support, as shown and described.

DESCRIPTION

FIG. 1 is a top, right side perspective view of an attachment support showing my new design;
 FIG. 2 is a top plan view of the attachment support of FIG. 1;
 FIG. 3 is a left side elevational view of the attachment support of FIG. 1;
 FIG. 4 is a front elevational view of the attachment support of FIG. 1, the rear elevational view being a mirror image thereof;
 FIG. 5 is a bottom plan view of the attachment support of FIG. 1; and,
 FIG. 6 is a right side elevational view of the attachment support of FIG. 1.

1 Claim, 1 Drawing Sheet

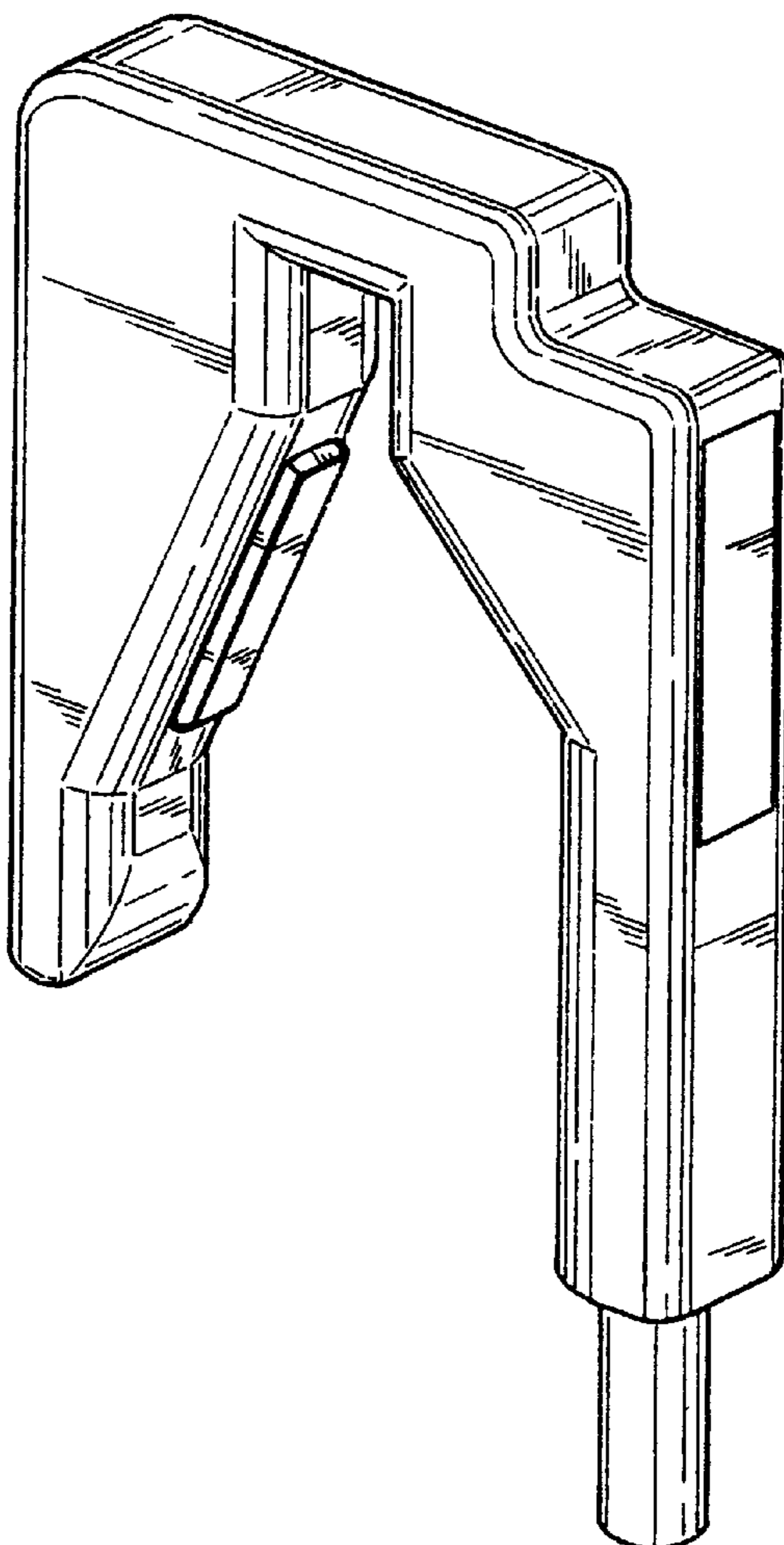

FIG.1

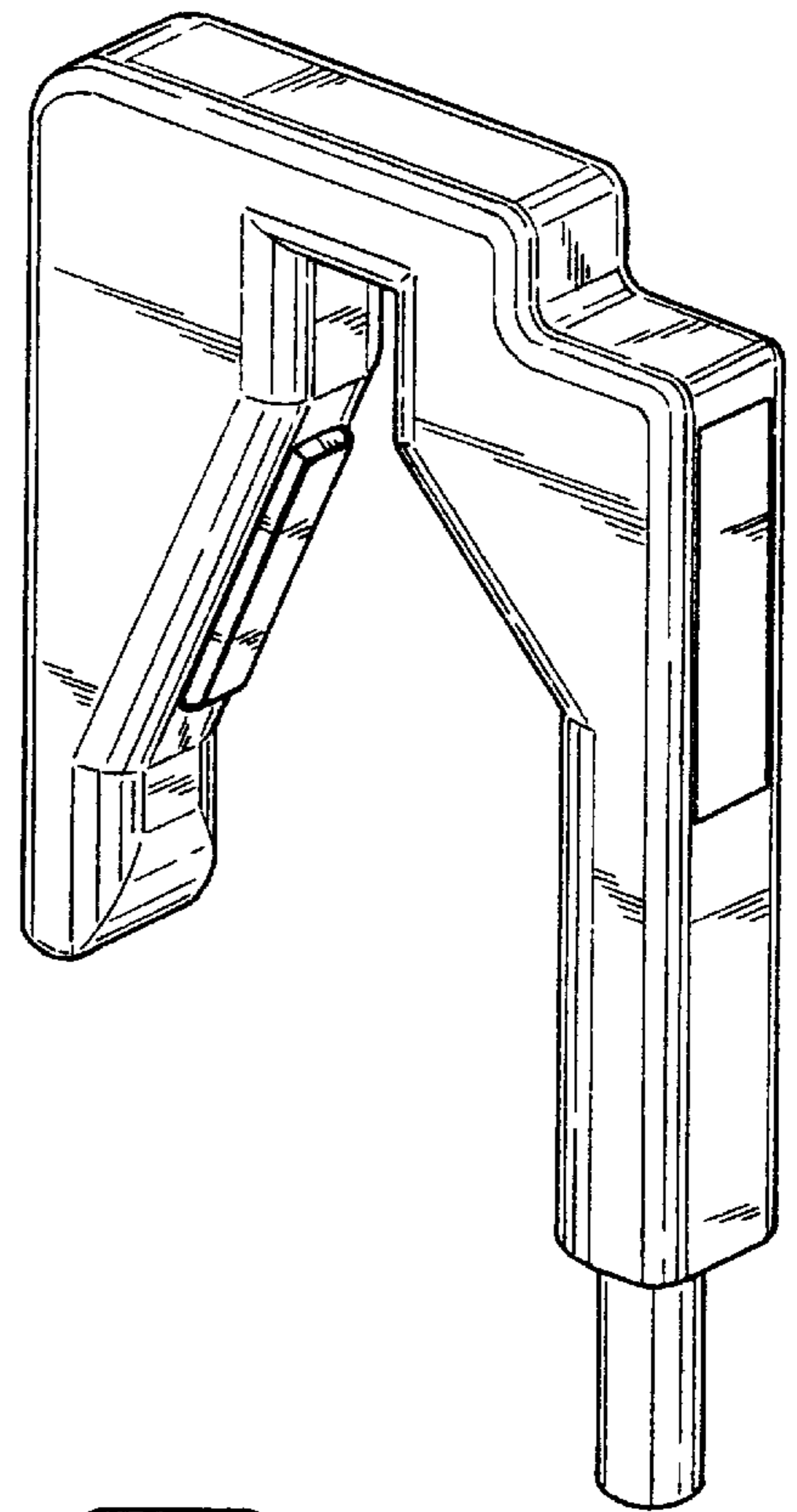

FIG.2

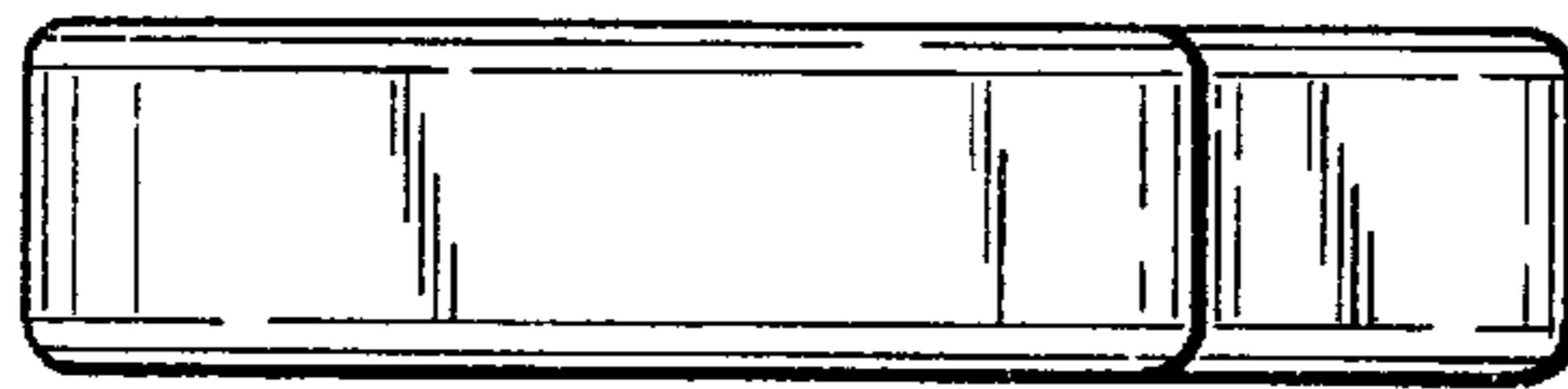

FIG.3

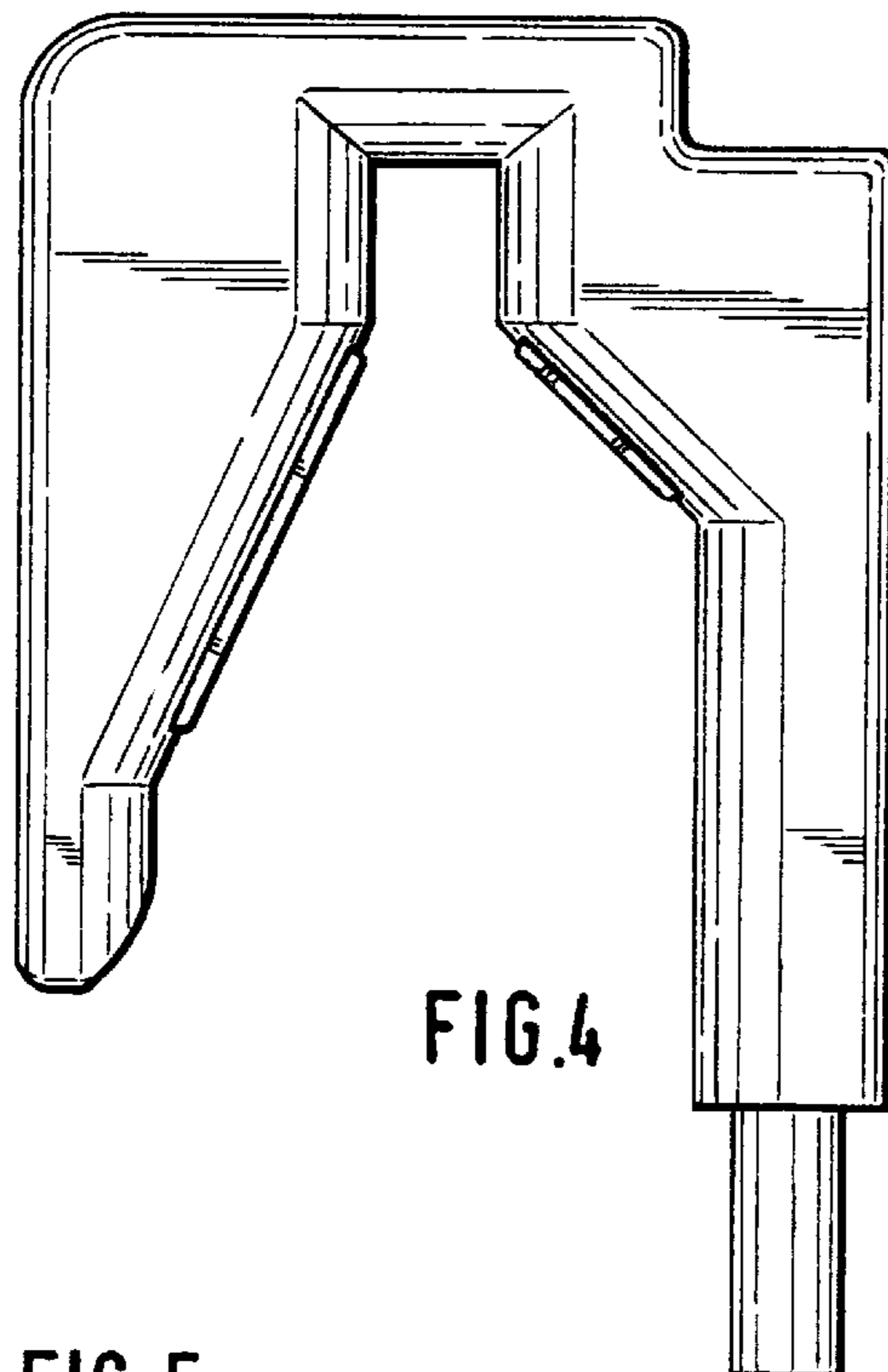
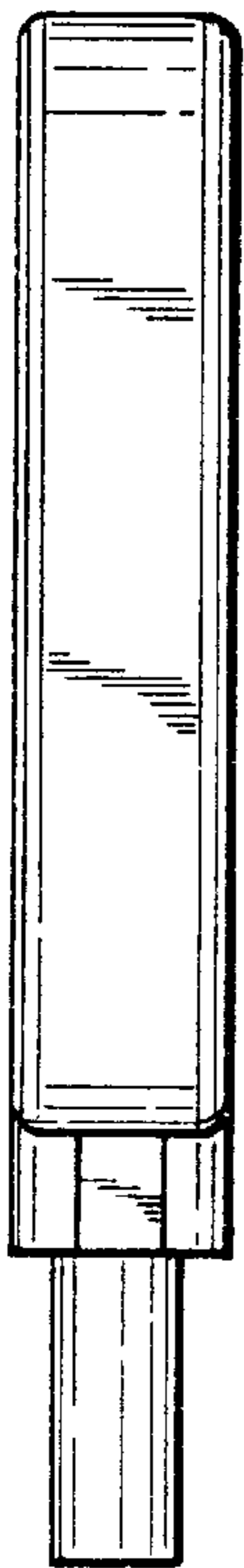

FIG.4

FIG.5

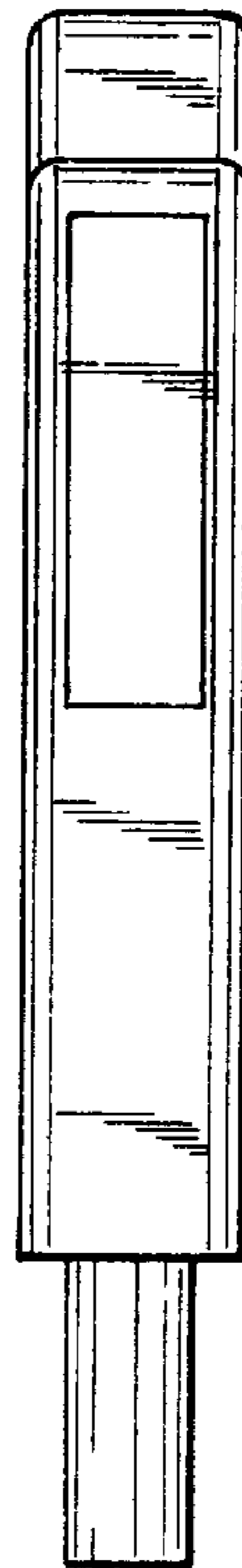
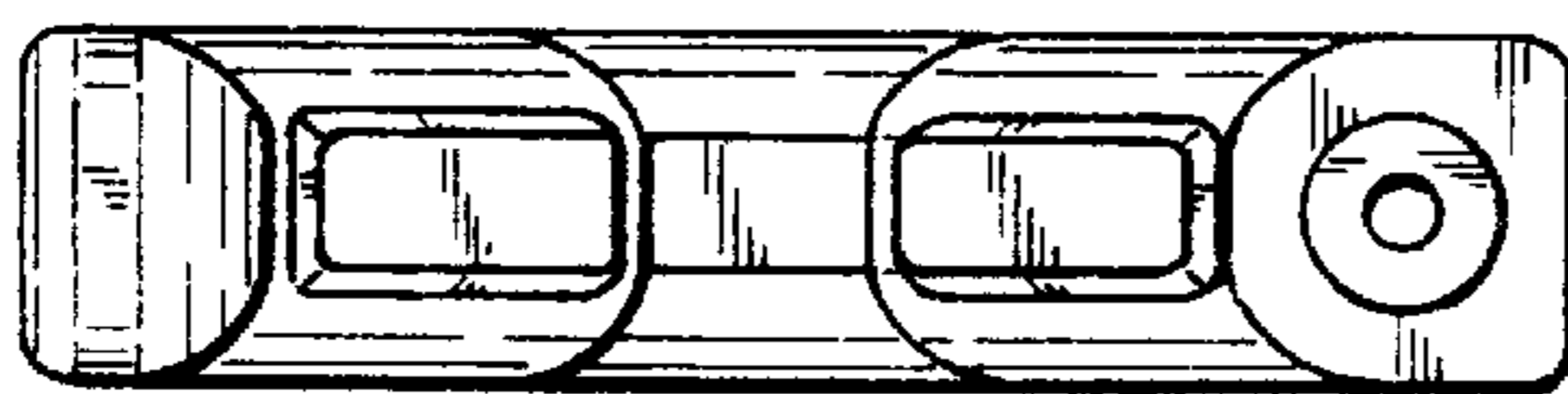

FIG.6