



US00D414123S

United States Patent [19]
Liu

[11] **Patent Number: Des. 414,123**

[45] **Date of Patent: ** Sep. 21, 1999**

[54] **TAPE MEASURE**

5,820,057 10/1998 Decarolis et al. 33/761 X

[76] Inventor: **Simon Liu**, P.O. Box 82-144, Taipei, Taiwan

Primary Examiner—Antoine Duval Davis
Attorney, Agent, or Firm—A & J

[**] Term: **14 Years**

[57] **CLAIM**

[21] Appl. No.: **29/091,362**

The ornamental design for a tape measure, as shown and described.

[22] Filed: **Jul. 28, 1998**

DESCRIPTION

[51] **LOC (6) Cl.** **10-04**

FIG. 1 is a perspective view of a tape measure, showing my new design;

[52] **U.S. Cl.** **D10/72**

FIG. 2 is a rear view thereof;

[58] **Field of Search** D10/72; 33/755-770

FIG. 3 is a front view thereof;

[56] **References Cited**

FIG. 4 is a right side elevational view thereof;

U.S. PATENT DOCUMENTS

FIG. 5 is a left side elevational view thereof;

D. 373,090 8/1996 Bennett D10/72

FIG. 6 is a top plan view thereof; and,

D. 376,546 12/1996 Lin D10/72

FIG. 7 is a bottom plan view thereof.

D. 399,149 10/1998 Bennett D10/72

1 Claim, 4 Drawing Sheets

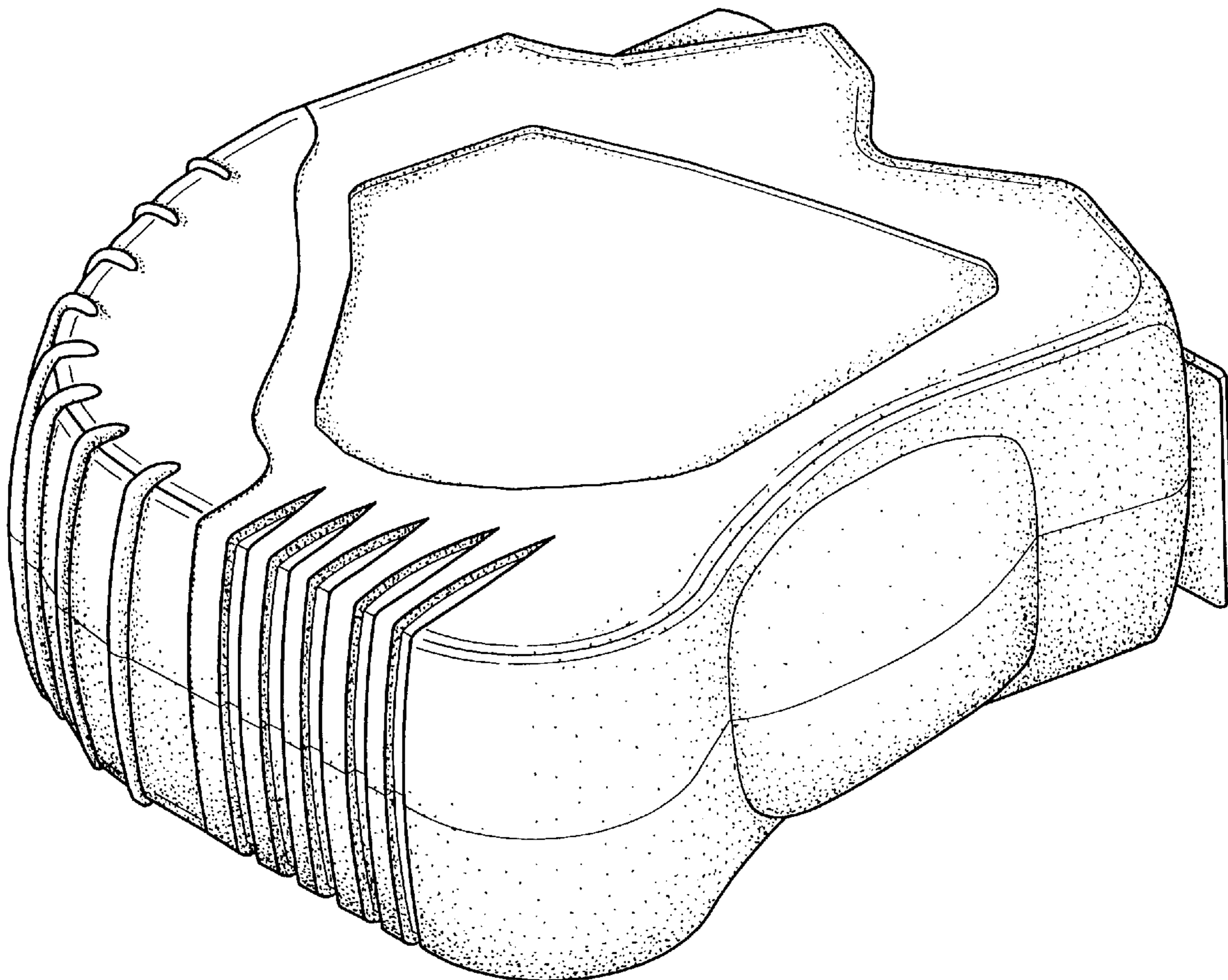

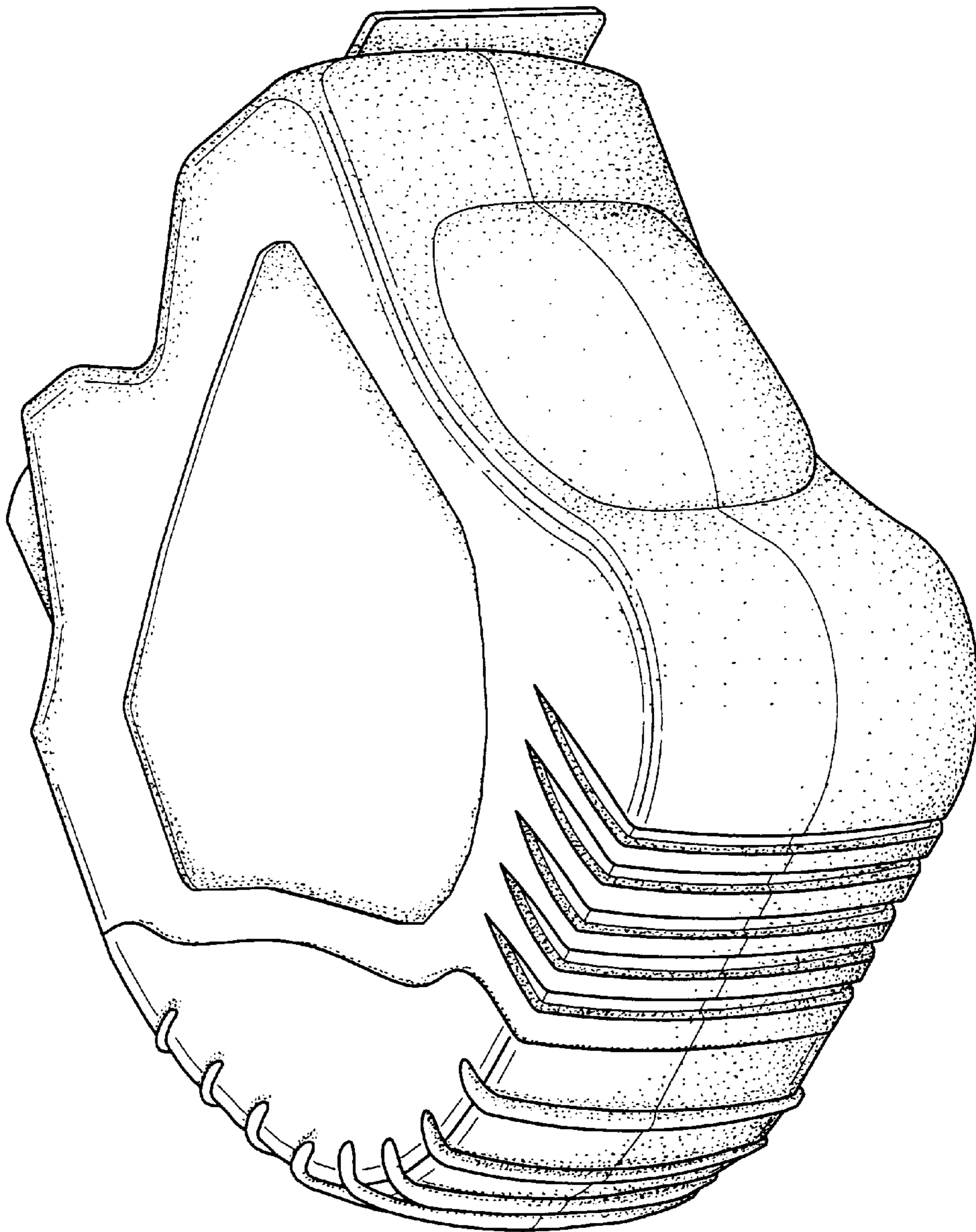

FIG. 1

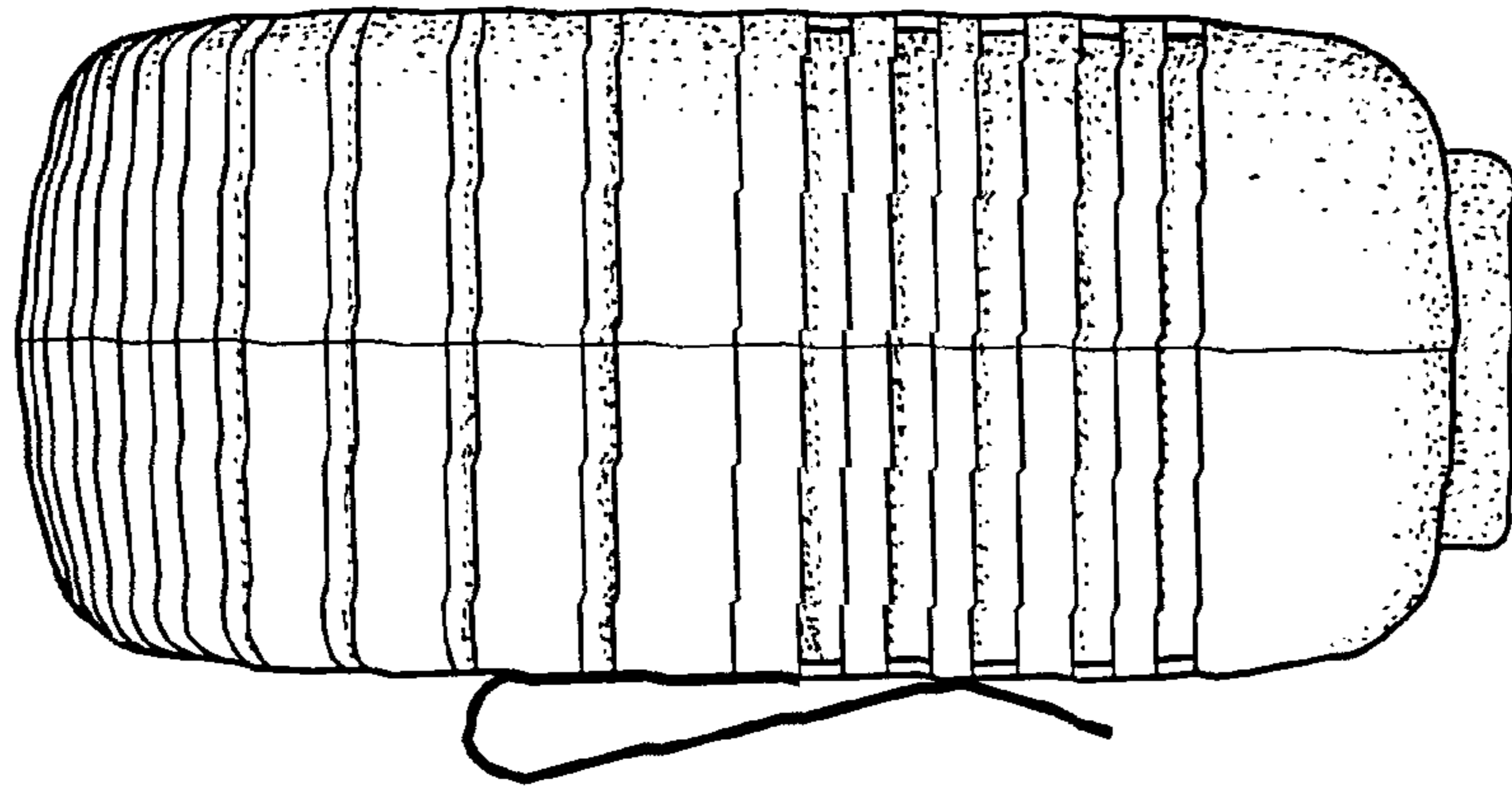

FIG. 3

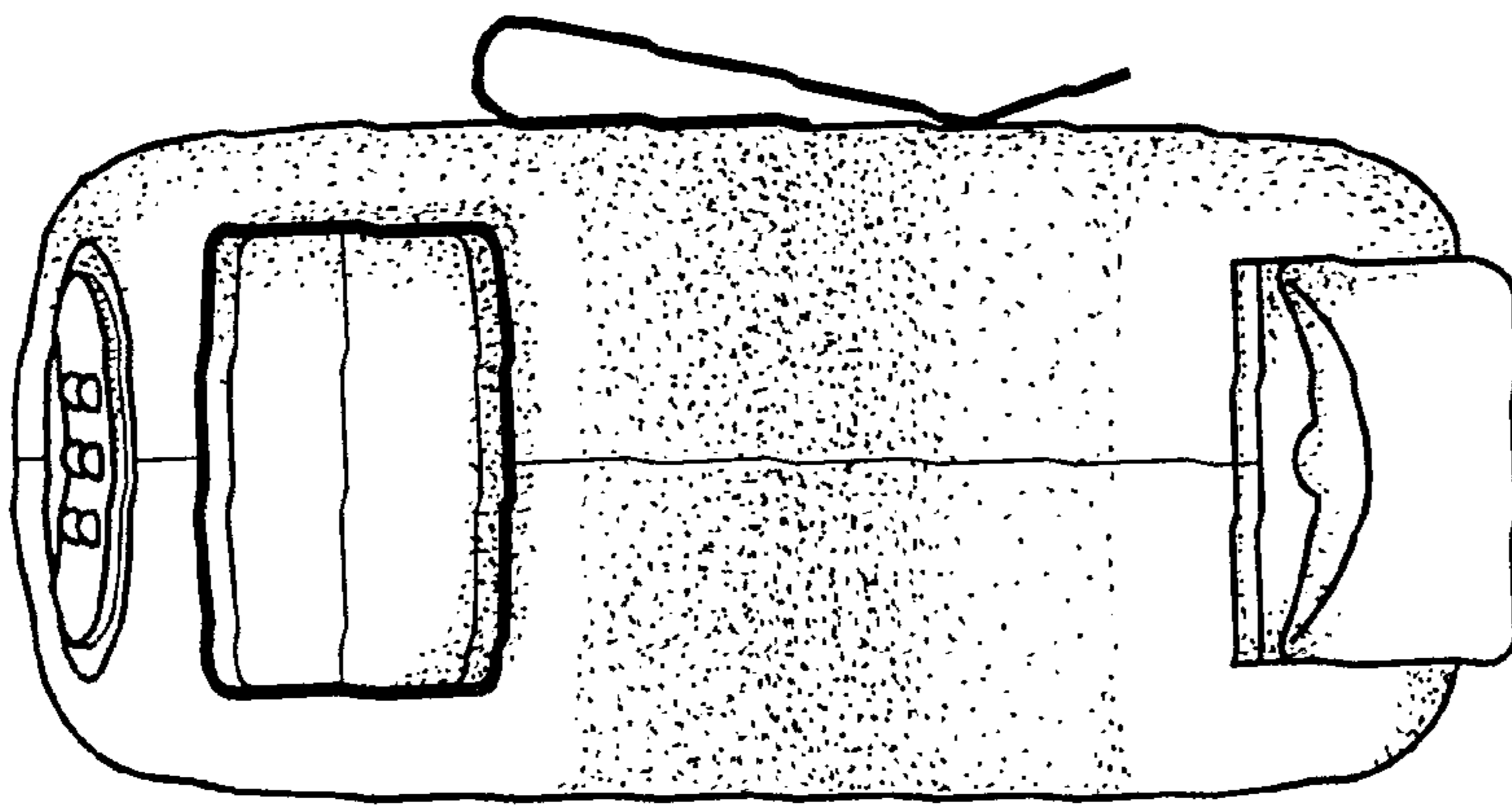

FIG. 2

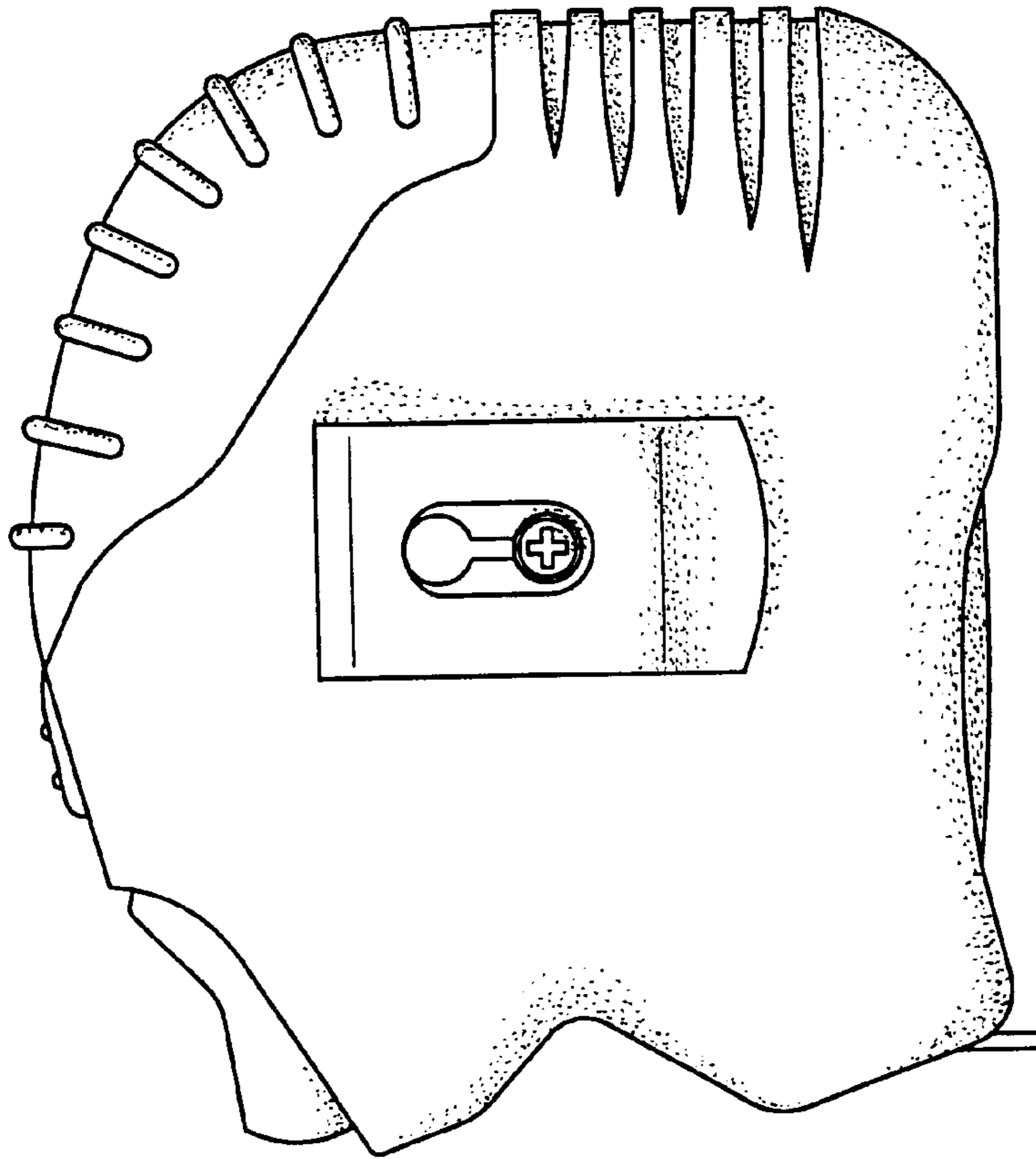

FIG.5

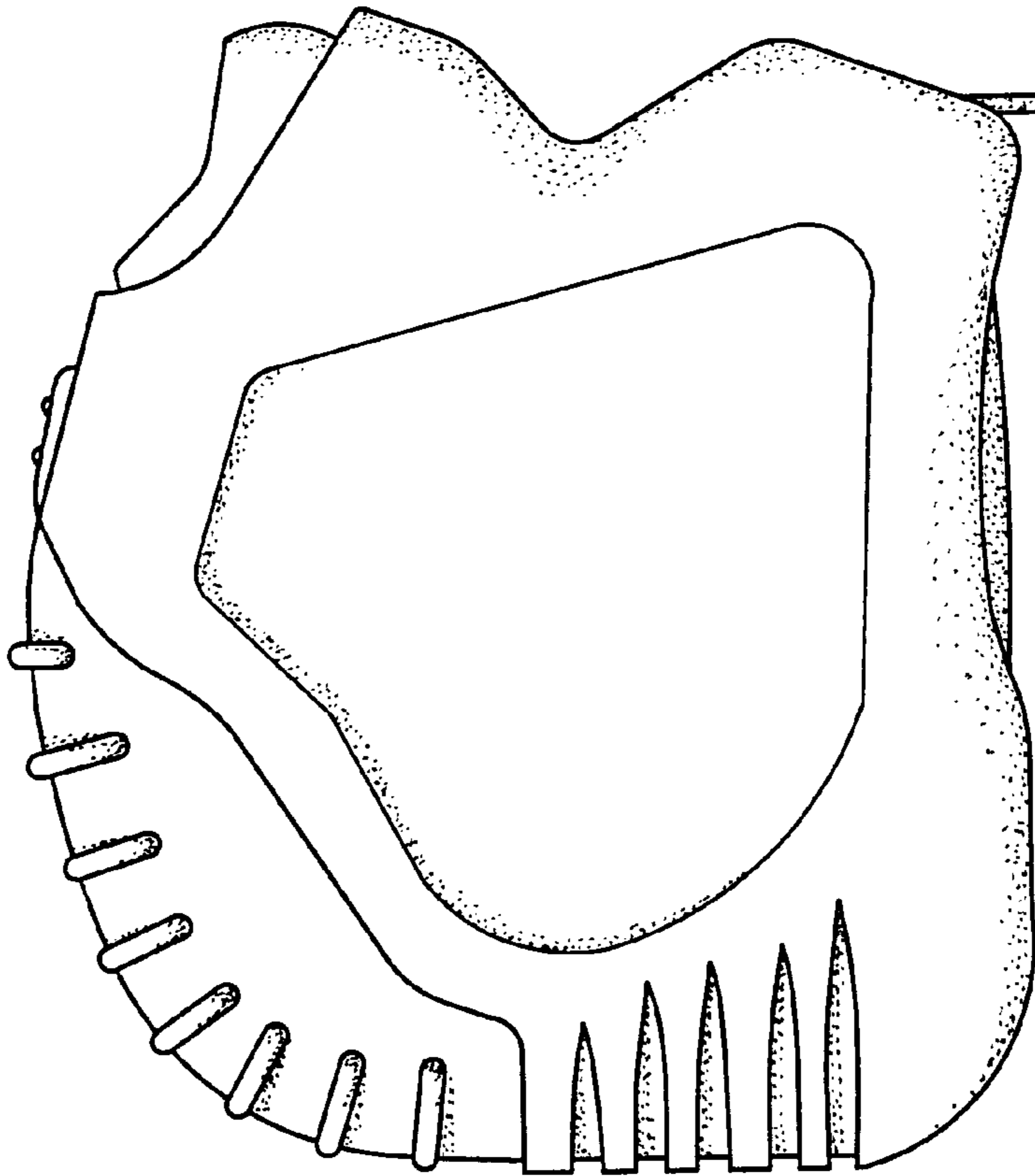

FIG.4

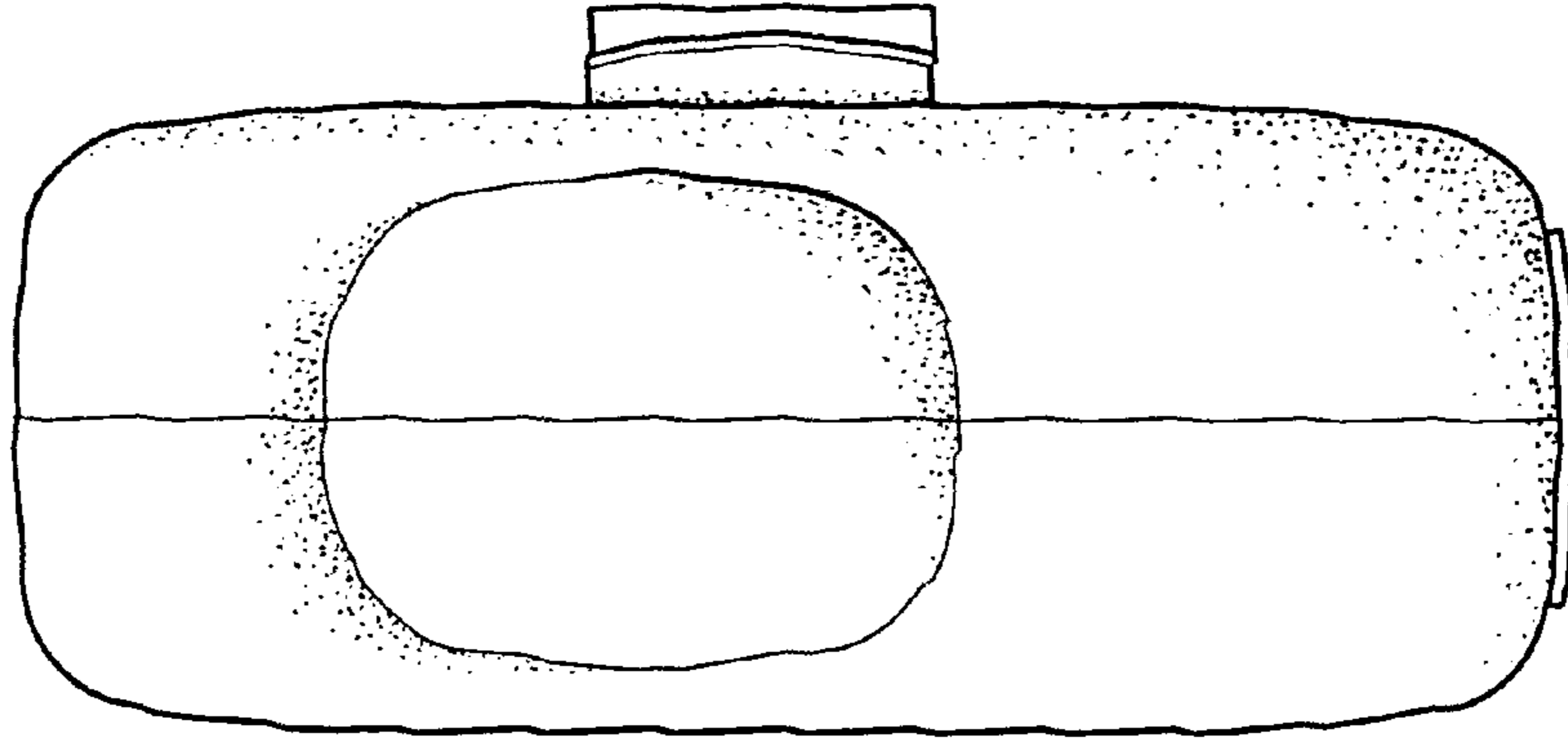

FIG. 6

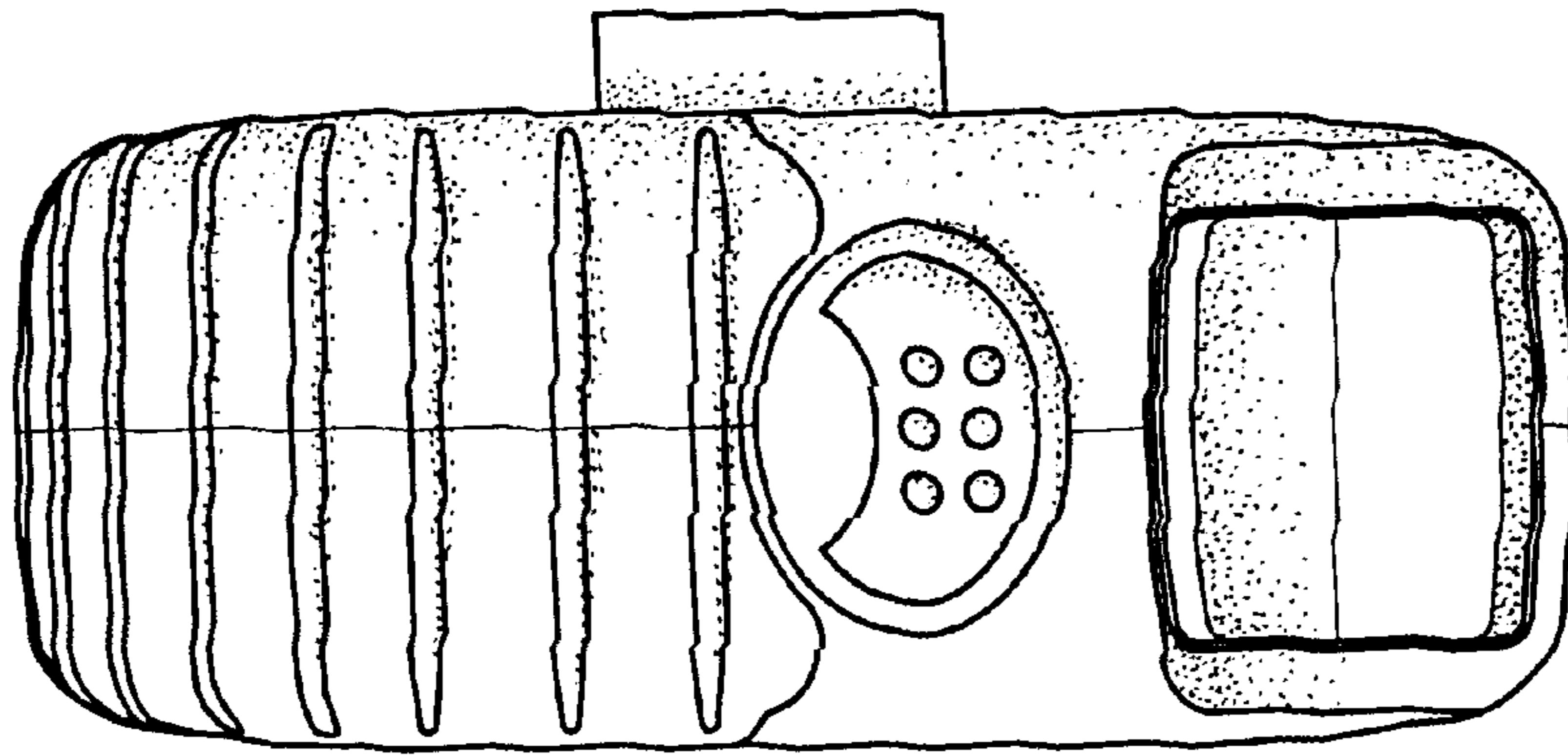

FIG. 7