



US00D413919S

United States Patent [19]

Kobayashi et al.

[11] **Patent Number: Des. 413,919**

[45] **Date of Patent: ** Sep. 14, 1999**

[54] **PRINTER FOR COMPUTER**

[75] Inventors: **Makoto Kobayashi; Shinichiro Yoshikawa**, both of Suwa, Japan

[73] Assignee: **Seiko Epson Corporation**, Tokyo, Japan

[**] Term: **14 Years**

[21] Appl. No.: **29/084,076**

[22] Filed: **Feb. 23, 1998**

[51] **LOC (6) Cl. 14-02**

[52] **U.S. Cl. D18/54**

[58] **Field of Search** D18/4, 14, 50, D18/54-55; 400/613, 613.1-613.4, 691-694, 690.1-690.4

[56] **References Cited**

U.S. PATENT DOCUMENTS

- D. 281,247 11/1985 Lahey et al. D18/55
- D. 287,497 12/1986 Goodner et al. D18/55
- D. 332,112 12/1992 Miyamoto et al. D18/55
- D. 372,733 8/1996 Yoshida et al. D18/55

- D. 374,032 9/1996 Kobayashi et al. D18/55
- D. 379,197 5/1997 Kiwahara et al. D18/55
- D. 379,827 6/1997 Andre D18/54
- D. 382,583 8/1997 Takahashi et al. D18/55
- D. 390,257 2/1998 Dwyer et al. D18/55
- D. 397,357 8/1998 Herman et al. D18/55
- D. 400,571 11/1998 Shimizu D18/54
- D. 400,572 11/1998 Sekine et al. D18/54

Primary Examiner—Cathy Anne MacCormac
Attorney, Agent, or Firm—Stroock & Stroock & Lavan LLP

[57] **CLAIM**

The ornamental design for a printer for computer, as shown and described.

DESCRIPTION

FIG. 1 is a perspective view of the top, front and right side of a printer for computer showing our new design; FIG. 2 is a front elevational view thereof; FIG. 3 is a rear elevational view thereof; FIG. 4 is a top plan view thereof; FIG. 5 is a right side elevational view thereof; FIG. 6 is a left side elevational view thereof; and, FIG. 7 is a bottom plan view thereof.

1 Claim, 3 Drawing Sheets

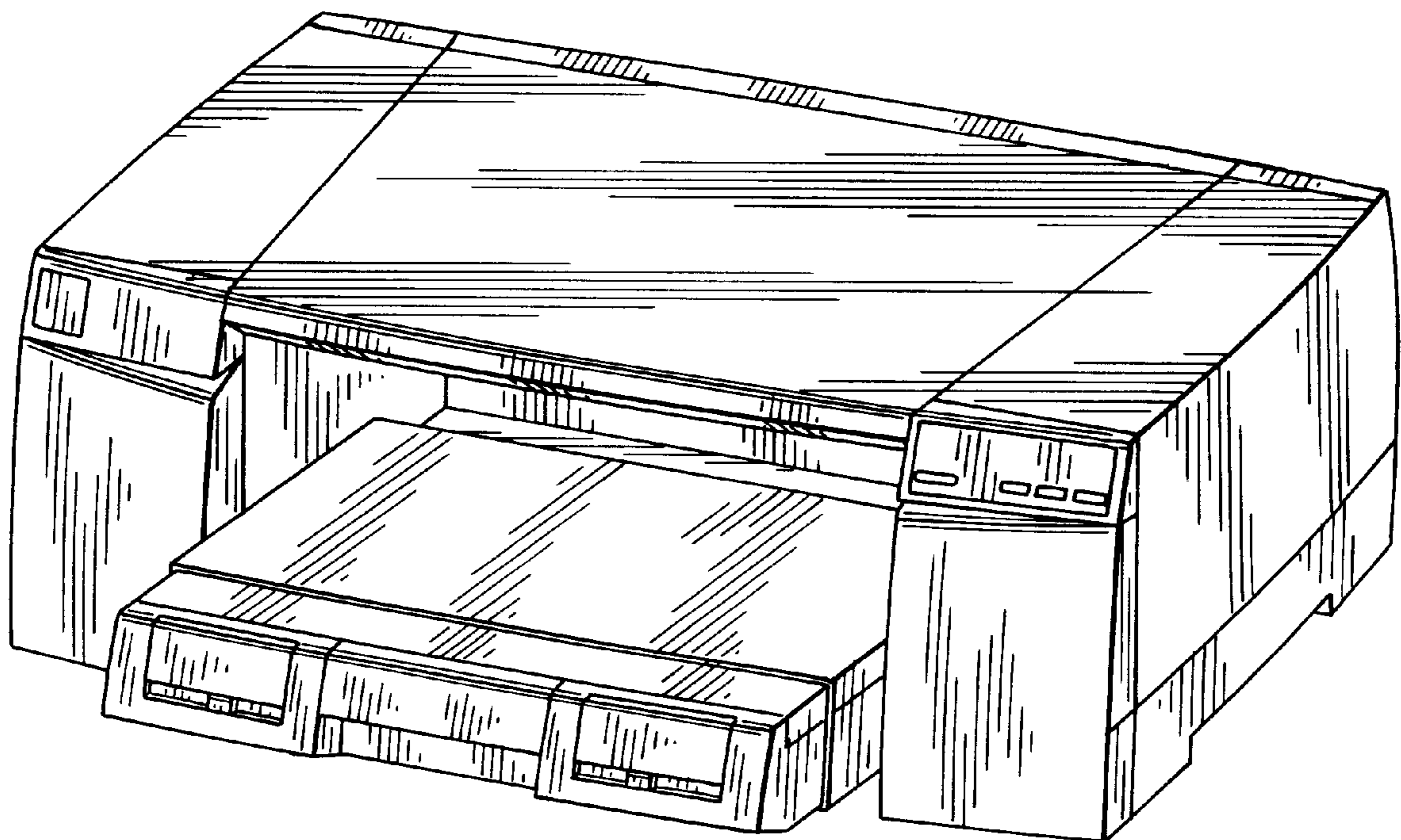

FIG. 1

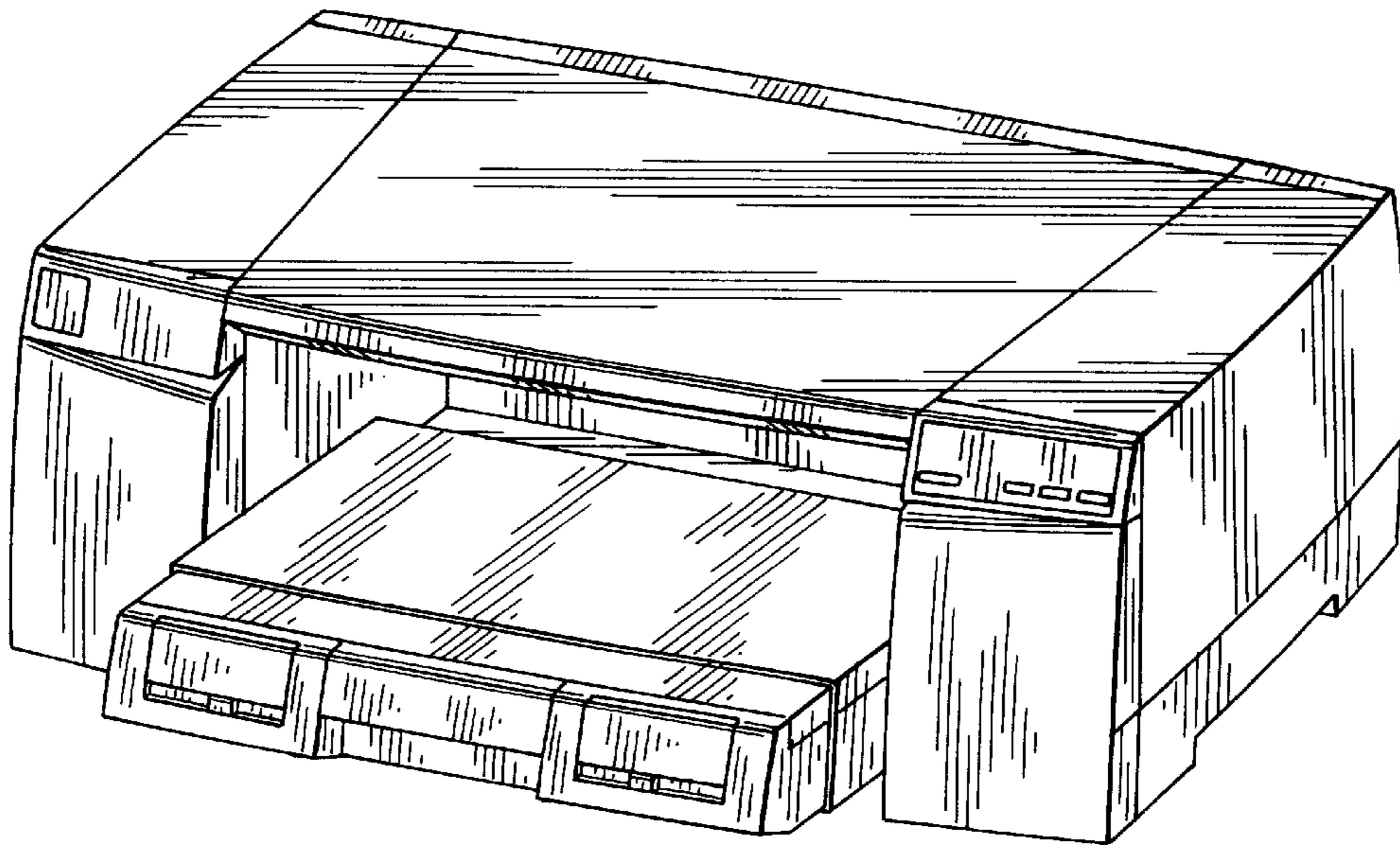

FIG. 2

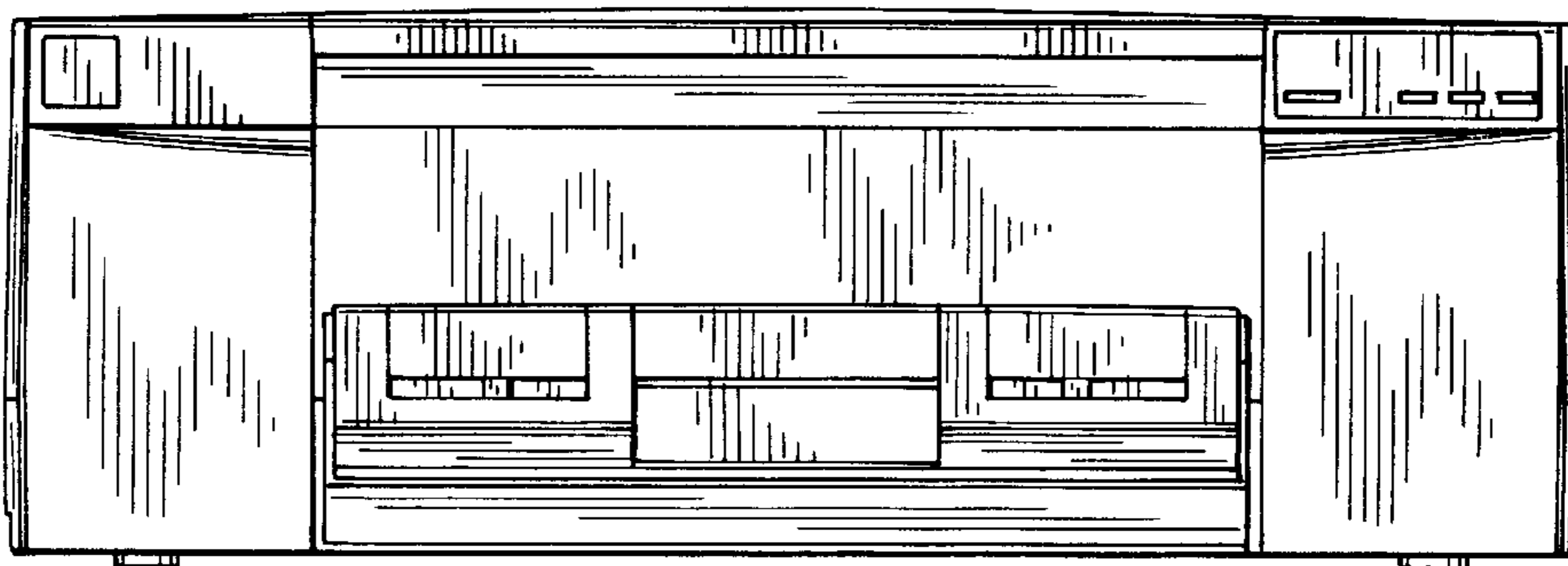

FIG. 3

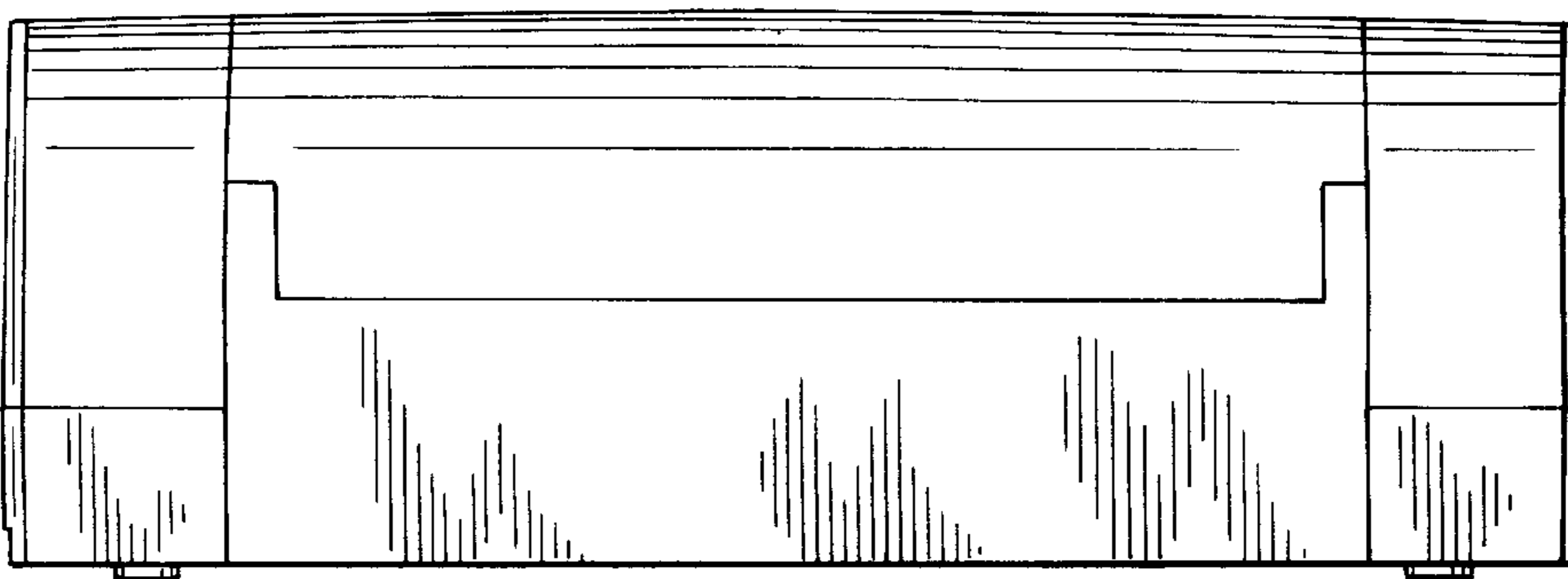

FIG. 4

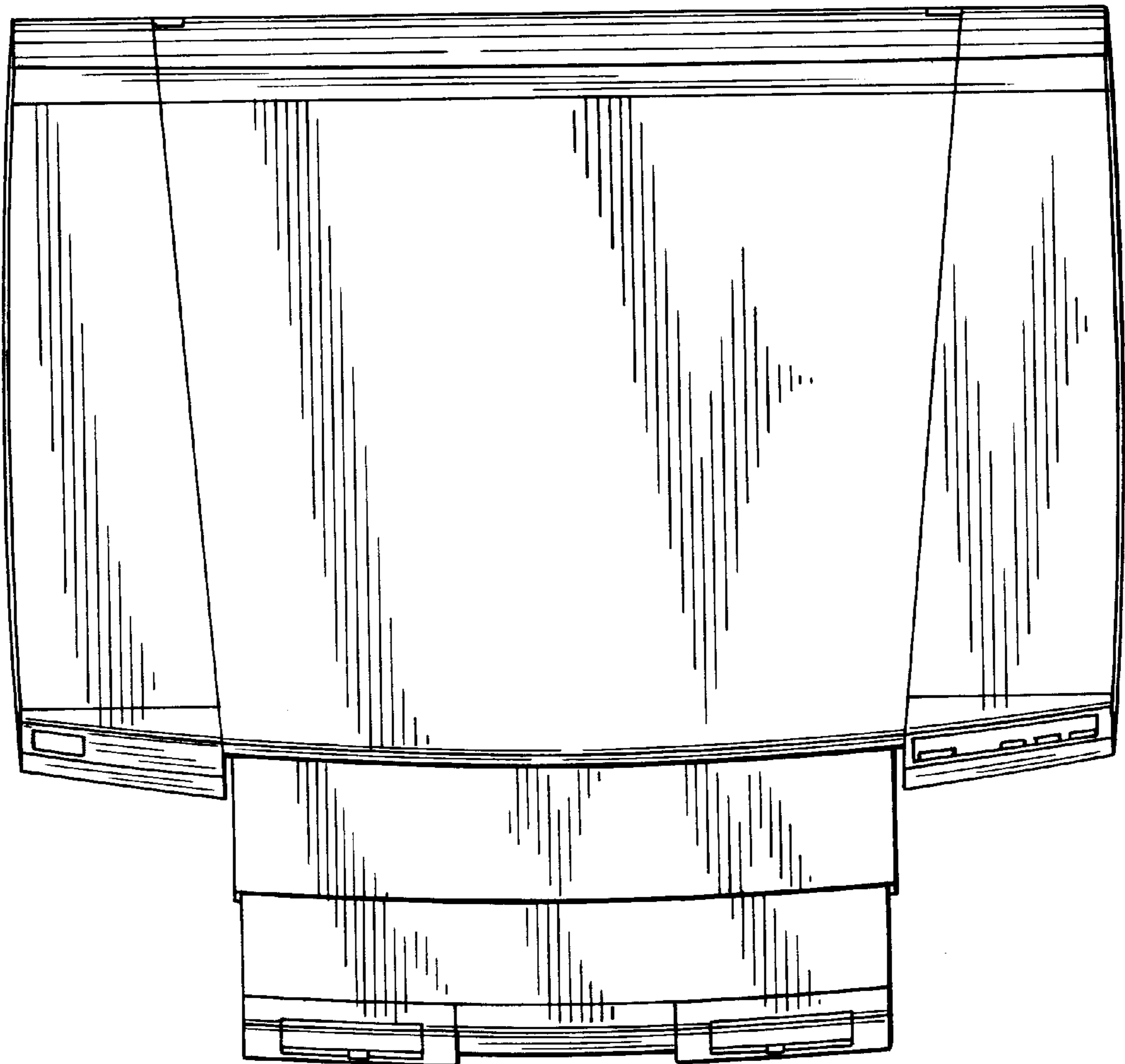

FIG. 5

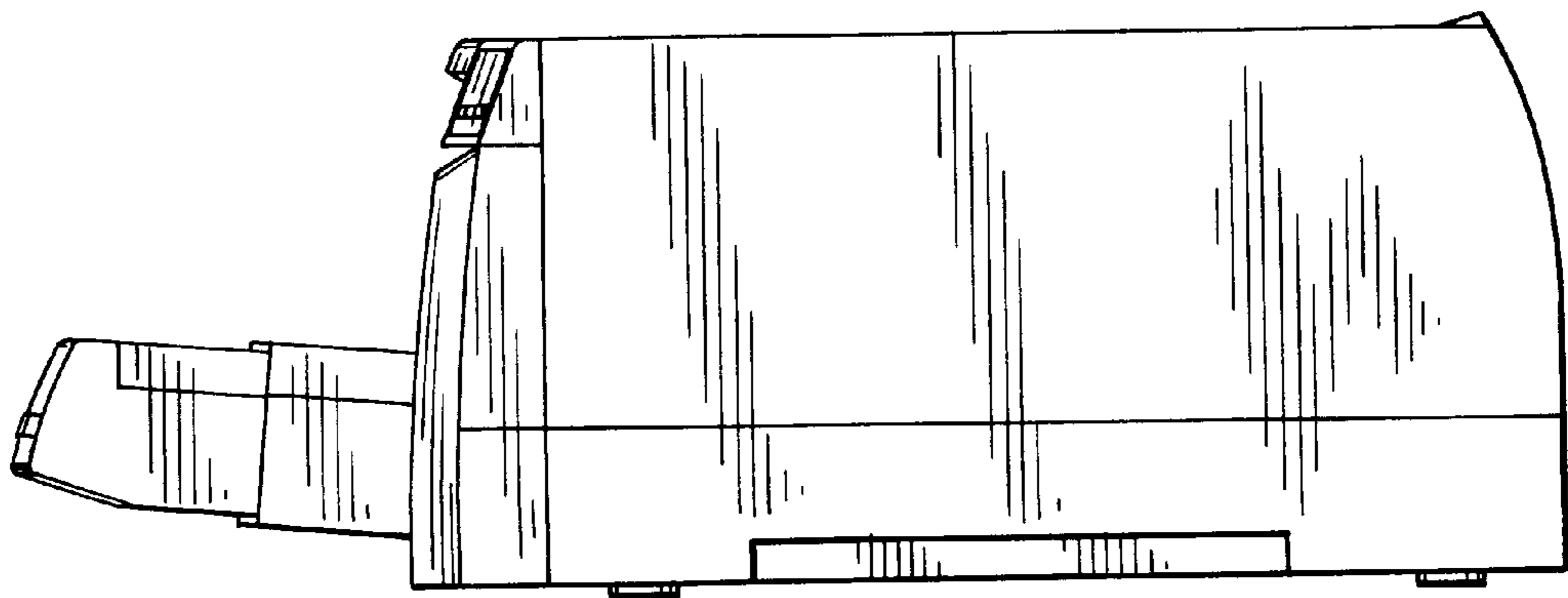

FIG. 6

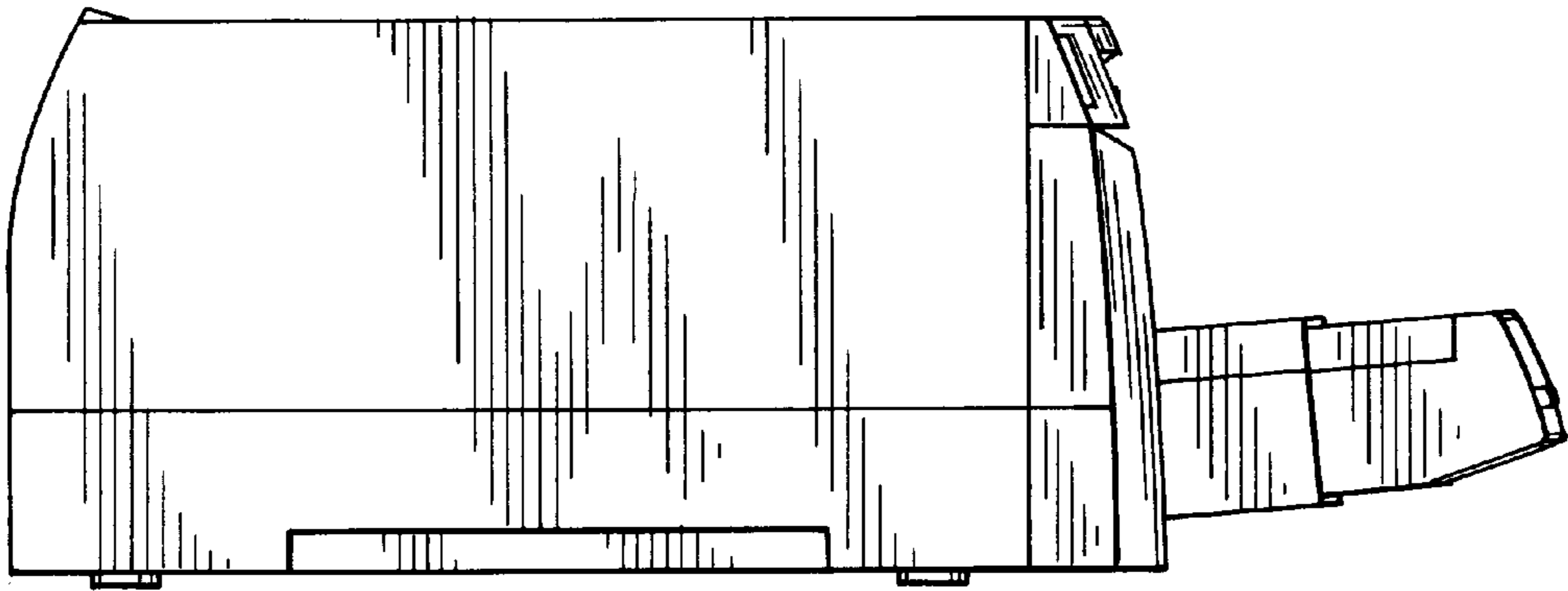

FIG. 7

