



US00D413835S

United States Patent [19] Guarriello

[11] **Patent Number: Des. 413,835**
[45] **Date of Patent: ** Sep. 14, 1999**

[54] **NURSERY CONTAINER UPPER PORTION**

[75] Inventor: **Joseph A. Guarriello**, Boiling Springs, Pa.

[73] Assignee: **Nursery Supplies, Inc.**, Chambersburg, Pa.

[**] Term: **14 Years**

[21] Appl. No.: **29/079,166**

[22] Filed: **Oct. 27, 1997**

[51] **LOC (6) Cl.** **11-02**

[52] **U.S. Cl.** **D11/164; D11/143**

[58] **Field of Search** D6/403, 562, 566, D6/556; D11/143-154; D9/341, 500, 430, 424, 432, 428, 455; D3/310-314; D7/554.1, 554.2, 557, 545, 566; 206/558, 561; 220/23.2, 23.4

[56] **References Cited**

U.S. PATENT DOCUMENTS

- 62,728 3/1867 Booker .
- 156,470 11/1874 Warner .
- D. 162,320 3/1951 Lake .
- D. 194,000 11/1962 Adams et al. .
- D. 207,174 3/1967 Rowbottam .
- D. 208,829 10/1967 Stockdale .
- D. 219,748 1/1971 Bixler D7/554.1
- D. 223,464 4/1972 Tisset .
- D. 239,129 3/1976 Rosenberger D11/143
- D. 253,872 1/1980 Reynolds D9/428
- D. 256,308 8/1980 Zimmermann .
- D. 259,774 7/1981 Criscitiello, Jr. .
- D. 260,751 9/1981 Lee et al. .
- D. 262,611 1/1982 Gonzales et al. .
- 289,102 11/1883 Holden .
- D. 302,403 7/1989 Heras et al. D11/143
- D. 316,835 5/1991 Ginsberg D11/143
- D. 326,830 6/1992 Vaughn .
- D. 327,234 6/1992 Vaughn .
- D. 338,636 8/1993 Moore .
- D. 338,812 8/1993 Scott, Jr. et al. .
- D. 341,539 11/1993 Davis et al. D9/430
- D. 342,335 12/1993 Bowlby D11/143 X
- D. 355,627 2/1995 Hou .

- D. 356,978 4/1995 Rahr .
- D. 360,382 7/1995 Weder et al. .
- D. 360,387 7/1995 Weder et al. .
- D. 369,120 4/1996 Deslen .
- D. 369,971 5/1996 Brauner et al. D9/426
- D. 374,414 10/1996 Weder et al. .
- D. 384,001 9/1997 Waszkiewicz, III D11/143
- 986,395 3/1911 King .
- 1,238,552 8/1917 Mitchell .
- 1,951,642 3/1934 Augustin et al. .
- 2,881,939 4/1959 Nelson .
- 3,021,001 2/1962 Donofrio 220/23.4
- 3,137,095 6/1964 Pearson .
- 3,310,218 3/1967 Reifers et al. .
- 3,515,036 6/1970 Oki et al. .
- 4,111,585 9/1978 Mascaro .
- 4,578,899 4/1986 Katila et al. .
- 4,612,726 9/1986 Mori .
- 4,763,443 8/1988 Williams .

Primary Examiner—Doris V. Coles
Assistant Examiner—Linda Brooks
Attorney, Agent, or Firm—Seidel, Gonda, Lavorgna & Monaco, PC

[57] **CLAIM**

The ornamental design for a nursery container upper portion, as shown and described.

DESCRIPTION

FIG. 1 is a front elevational view of a first embodiment of a nursery container upper portion showing our new design, the rear elevational view is identical;

FIG. 2 is a right side elevational view of the nursery container upper portion shown in FIG. 1, the left side elevational view is identical;

FIG. 3 is a top plan view of the nursery container upper portion shown in FIG. 1;

FIG. 4 is a bottom plan view of the nursery container upper portion shown in FIG. 1;

FIG. 5 is a front elevational view of a second embodiment of a nursery container upper portion showing our new design;

FIG. 6 is a rear elevational view of the nursery container upper portion shown in FIG. 5;

FIG. 7 is a right side elevational view of the nursery container upper portion shown in FIG. 5;

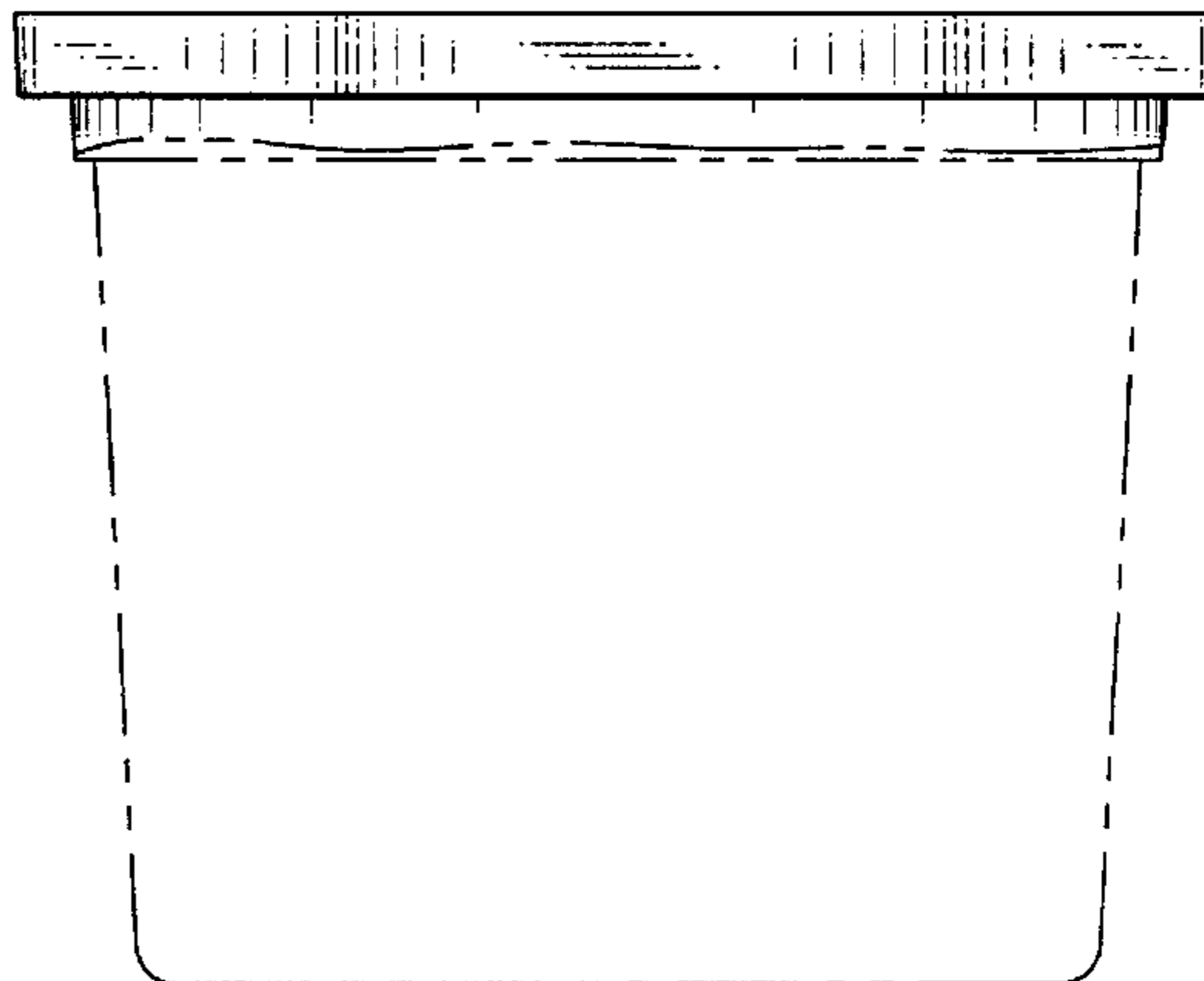
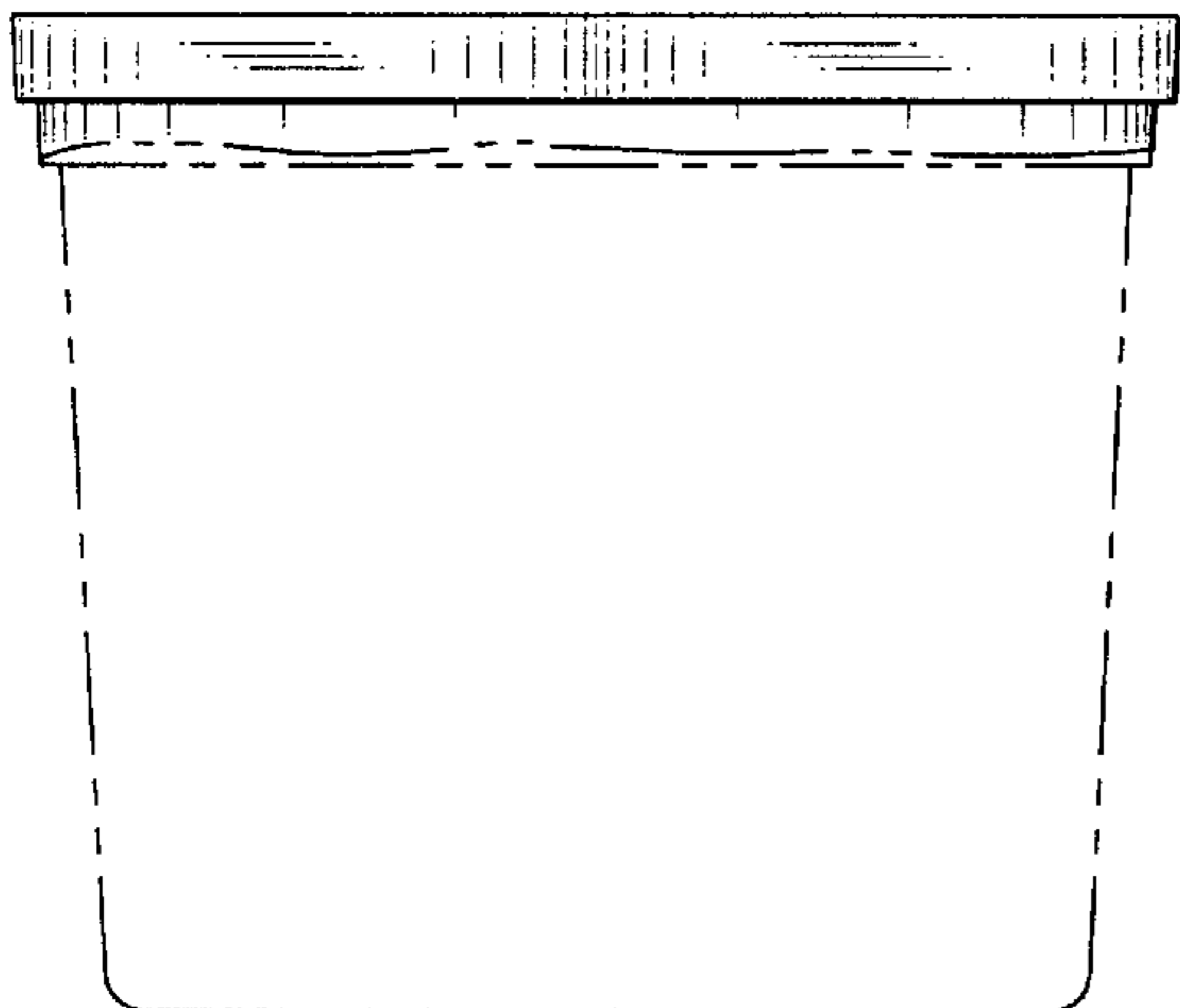

FIG. 8 is a left side elevational view of the nursery container upper portion shown in FIG. 5;

FIG. 9 is a top plan view of the nursery container upper portion shown in FIG. 5;

FIG. 10 is a bottom plan view of the nursery container upper portion shown in FIG. 5;

FIG. 11 is a front elevational view of another embodiment of a nursery container upper portion showing our new design, the right, left and rear elevational views are identical;

FIG. 12 is a top plan view of the nursery container upper portion shown in FIG. 11;

FIG. 13 is a bottom plan view of the nursery container upper portion shown in FIG. 11;

FIG. 14 is a front elevational view of yet another embodiment of a nursery container upper portion showing our new design, the right, left and rear elevational views are identical;

FIG. 15 is a top plan view of the nursery container upper portion shown in FIG. 14; and,

FIG. 16 is a bottom elevational view of the nursery container upper portion shown in FIG. 14.

The broken lines showing the boundaries and lower portion of the nursery container form no part of the claimed design.

1 Claim, 6 Drawing Sheets

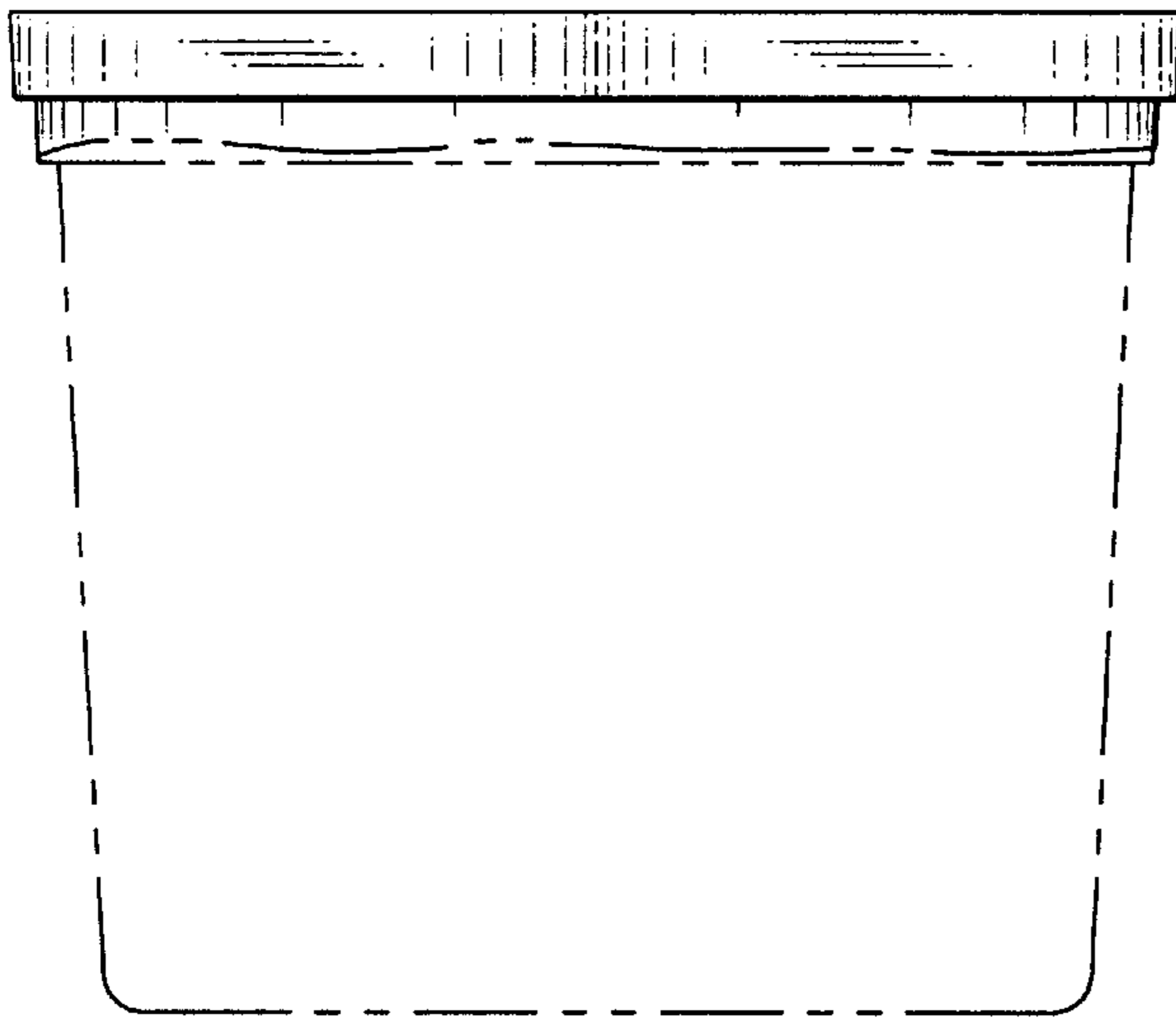

FIG. 1

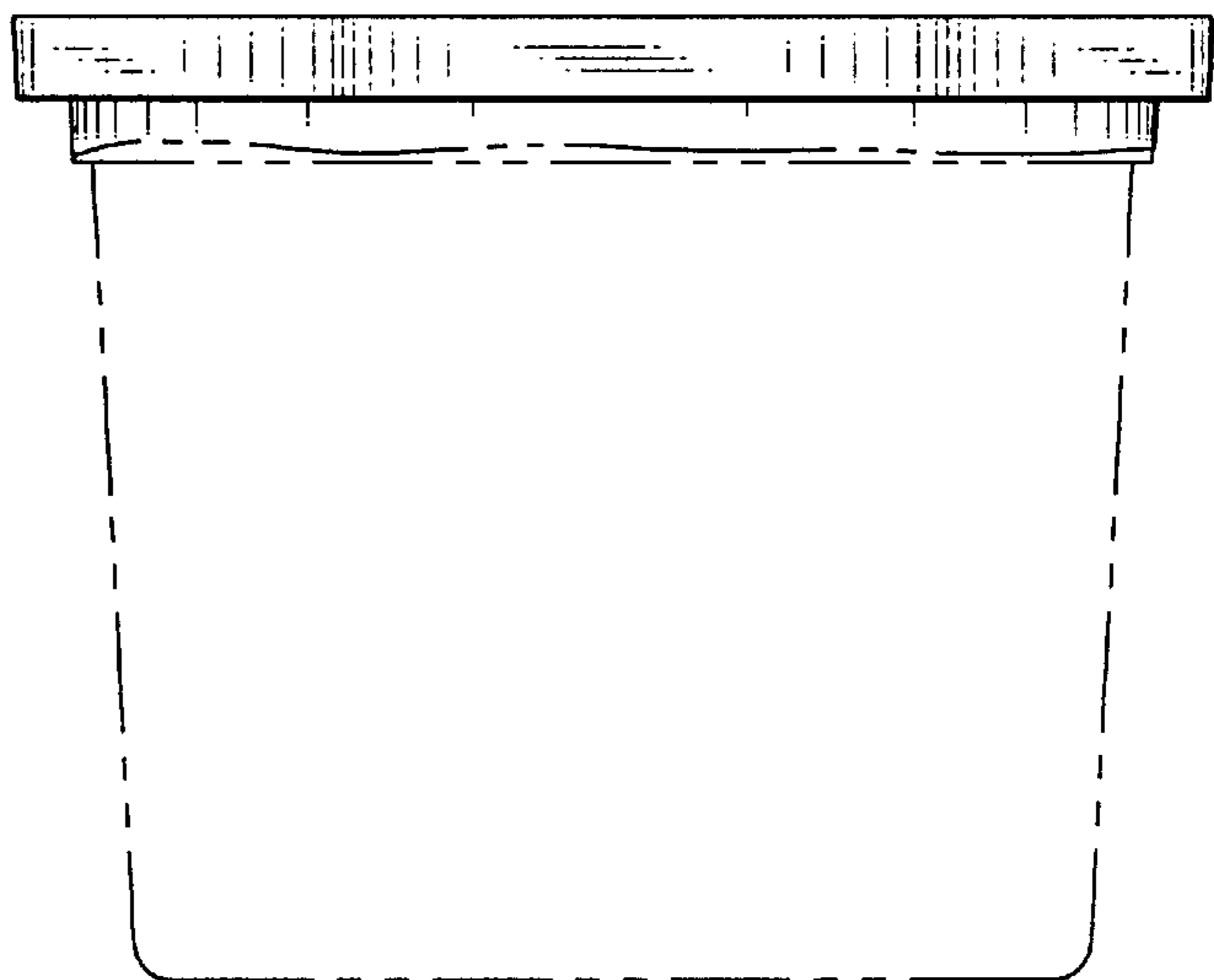

FIG. 2

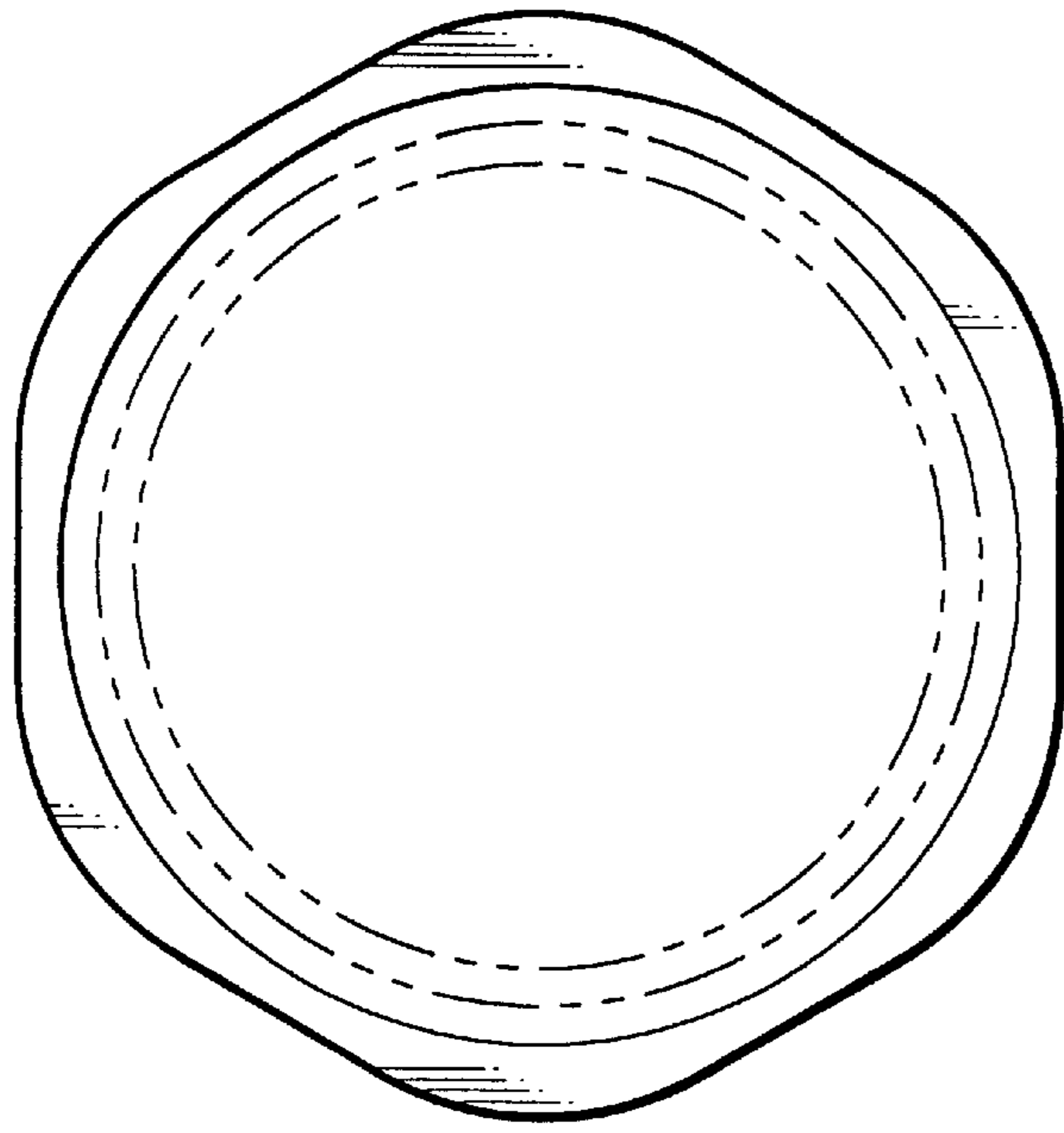

FIG. 3

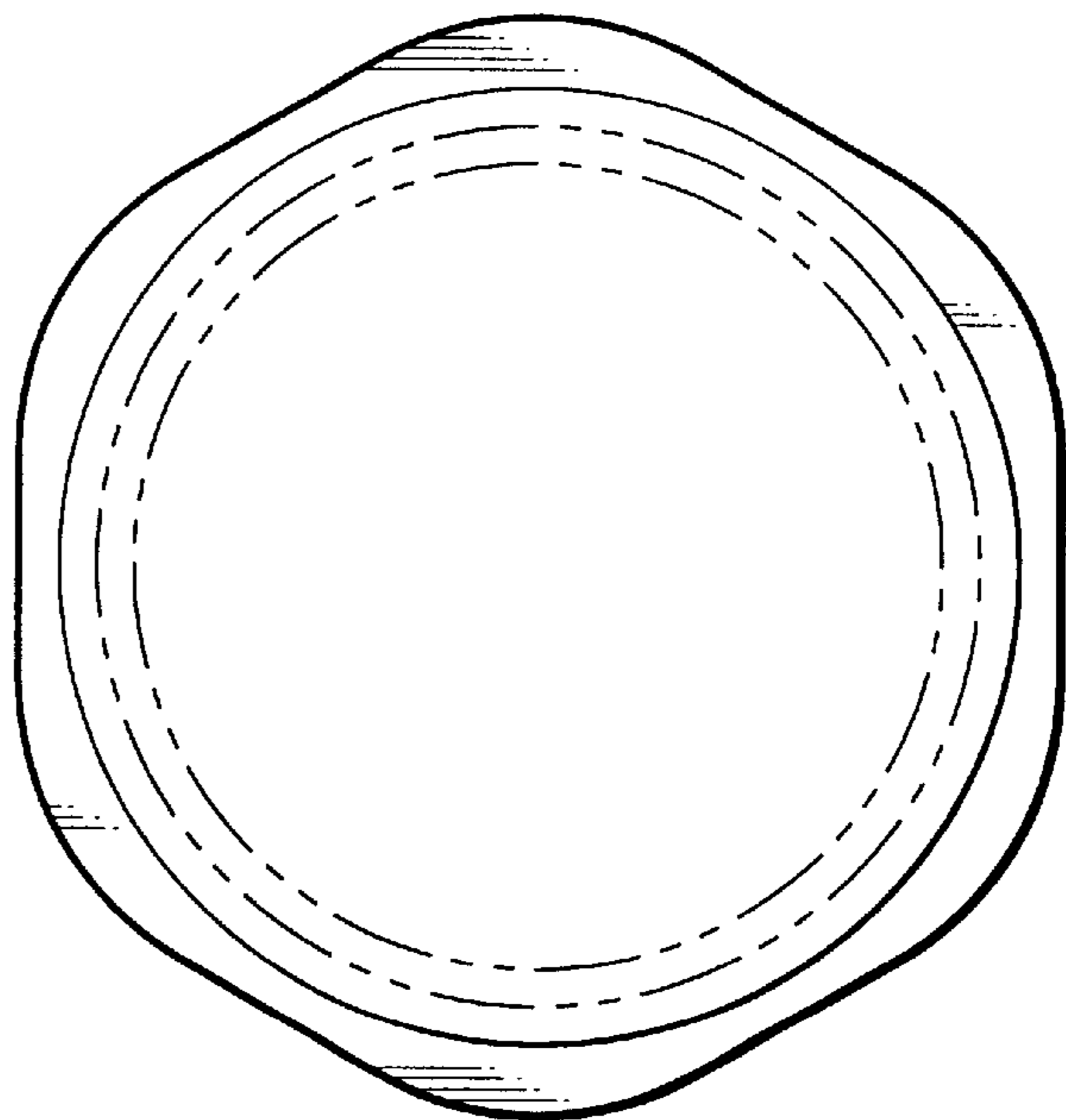

FIG. 4

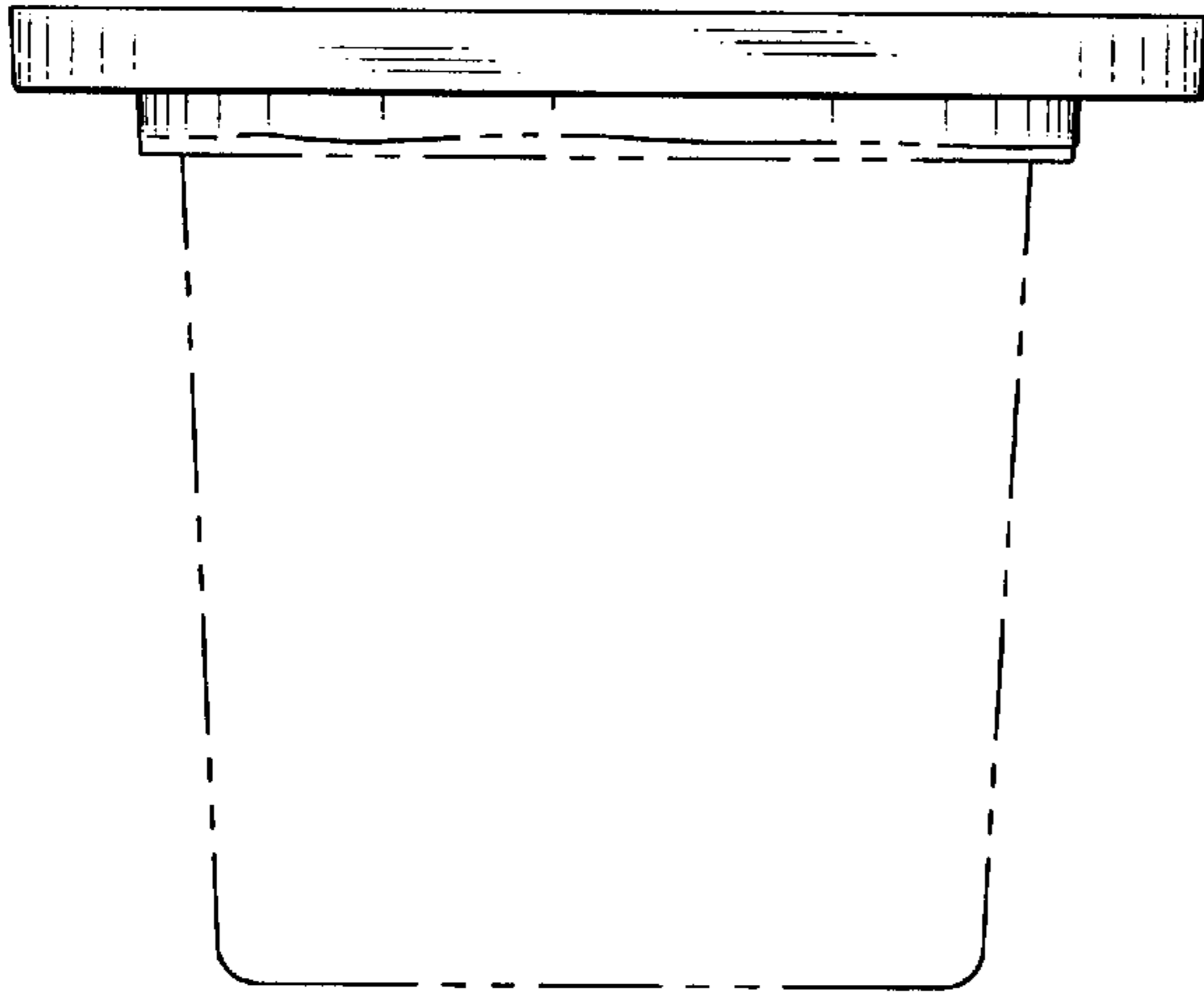

FIG. 5

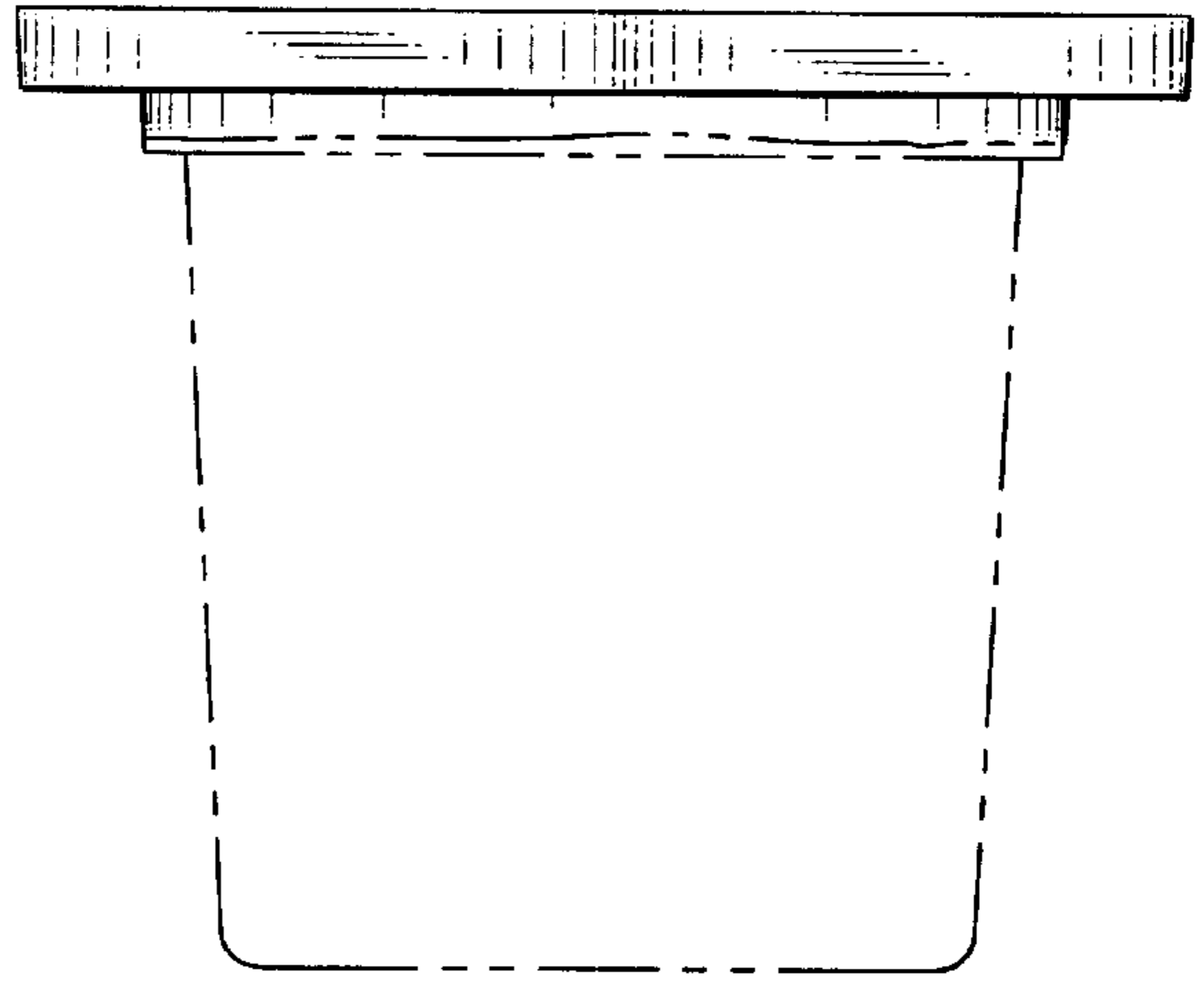

FIG. 6

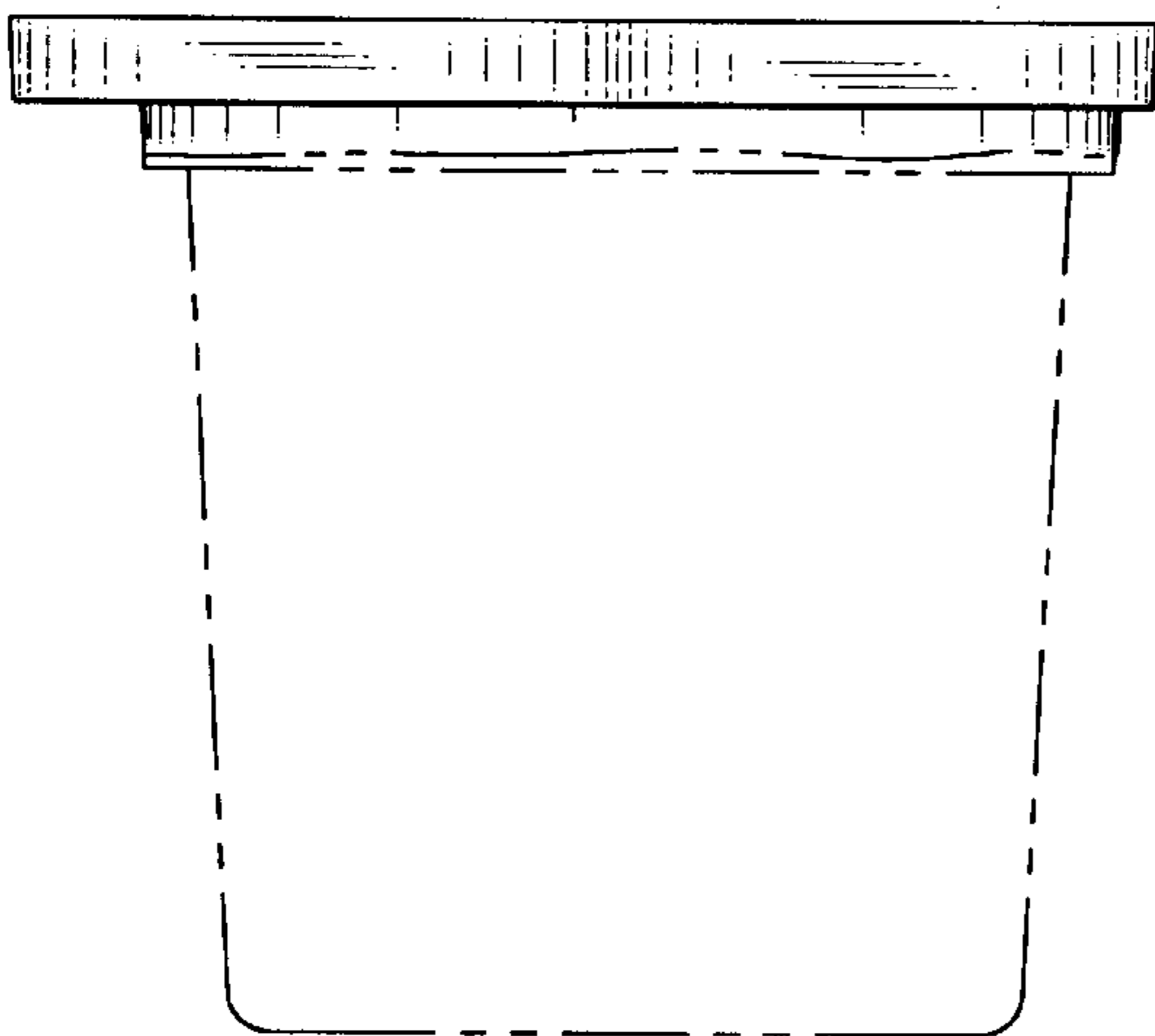

FIG. 7

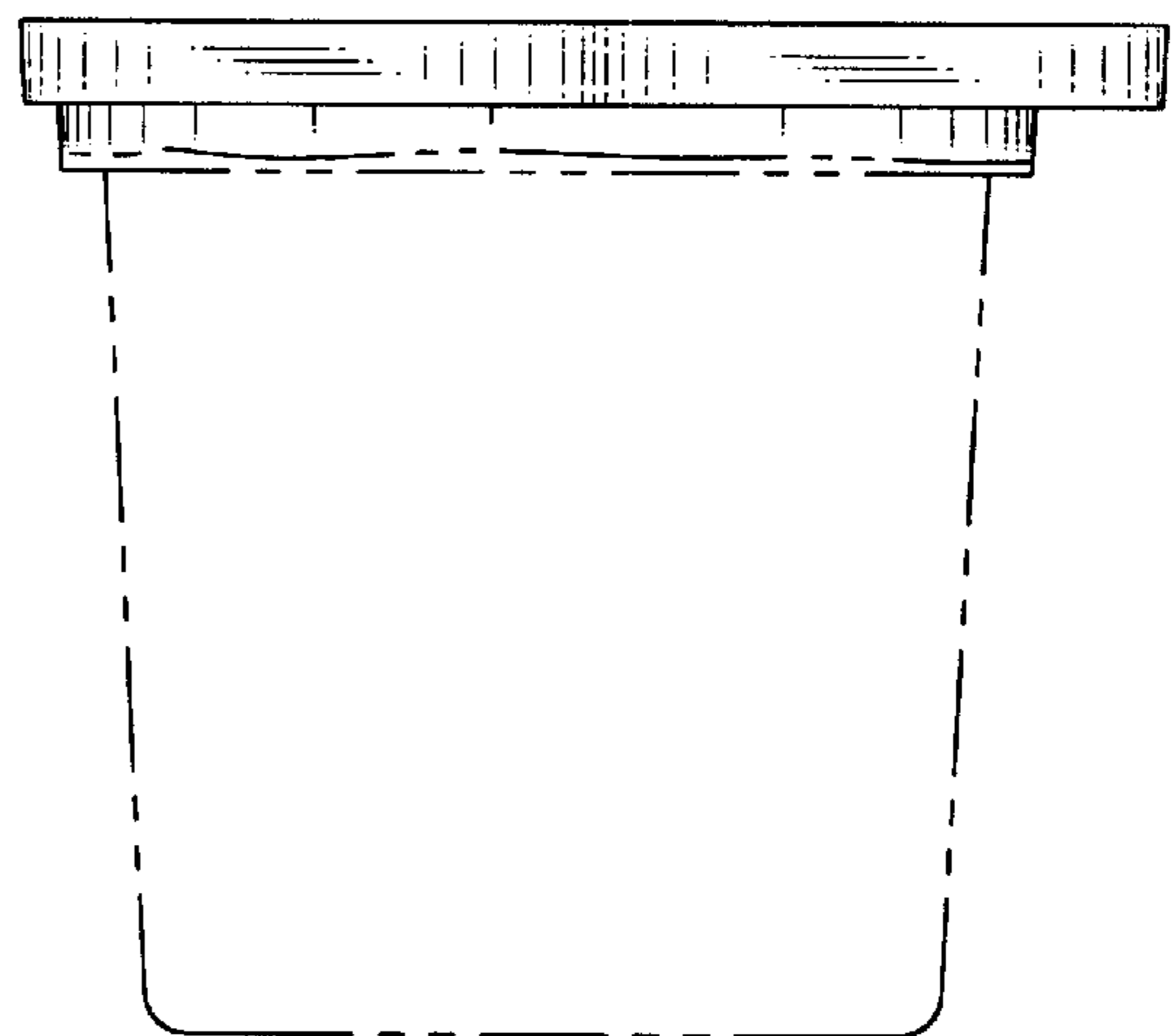

FIG. 8

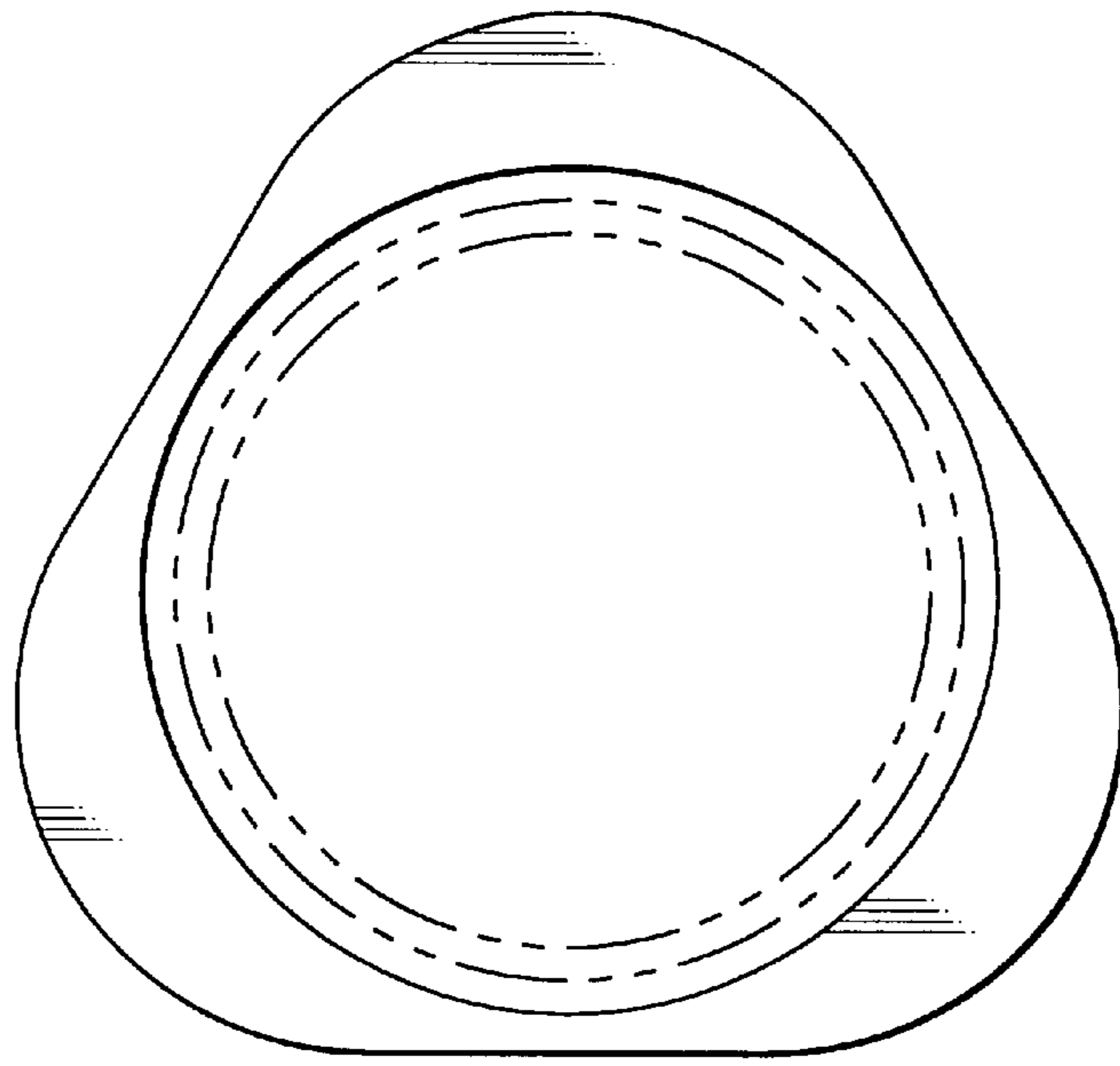

FIG. 9

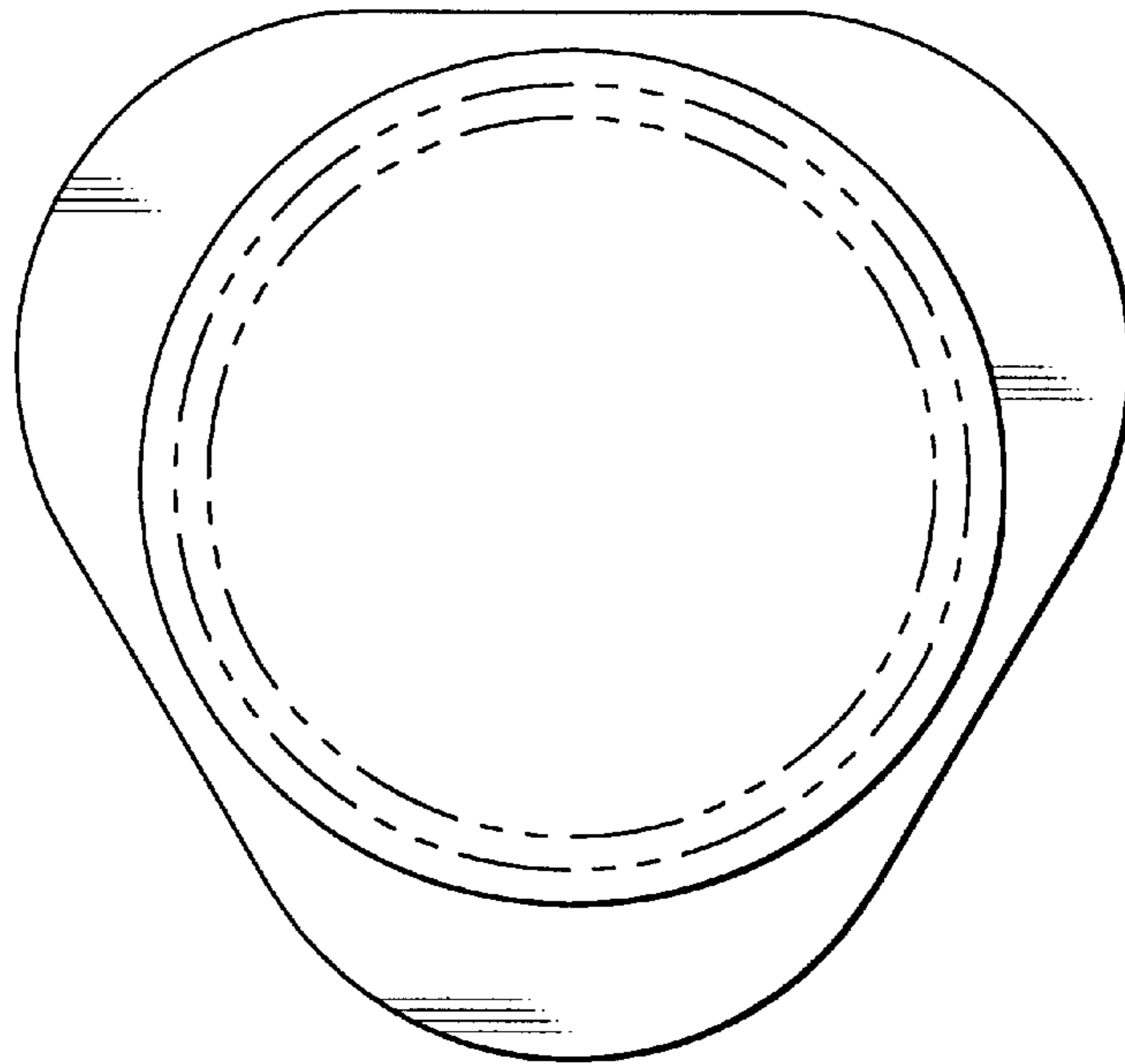

FIG. 10

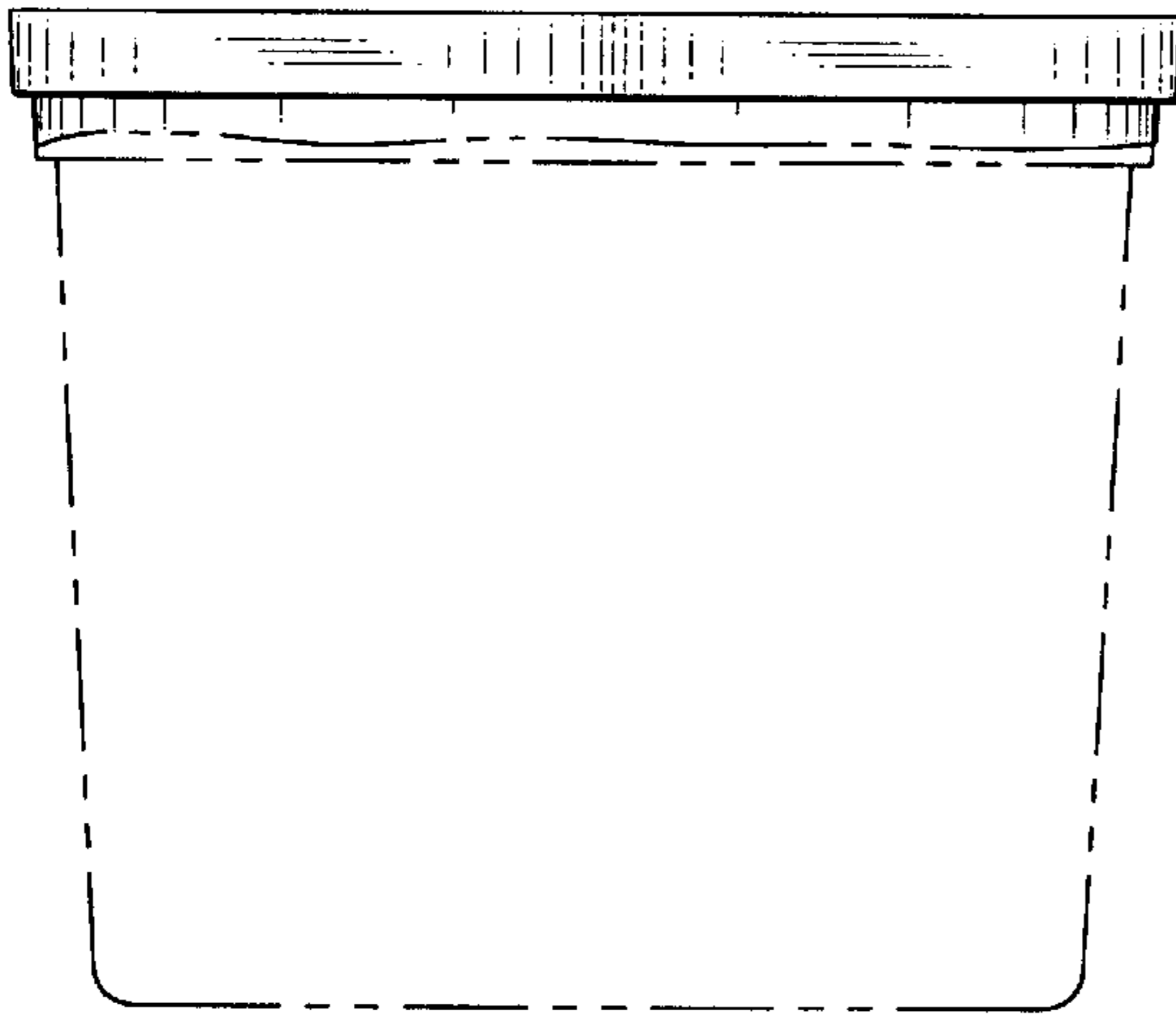

FIG. 11

FIG. 12

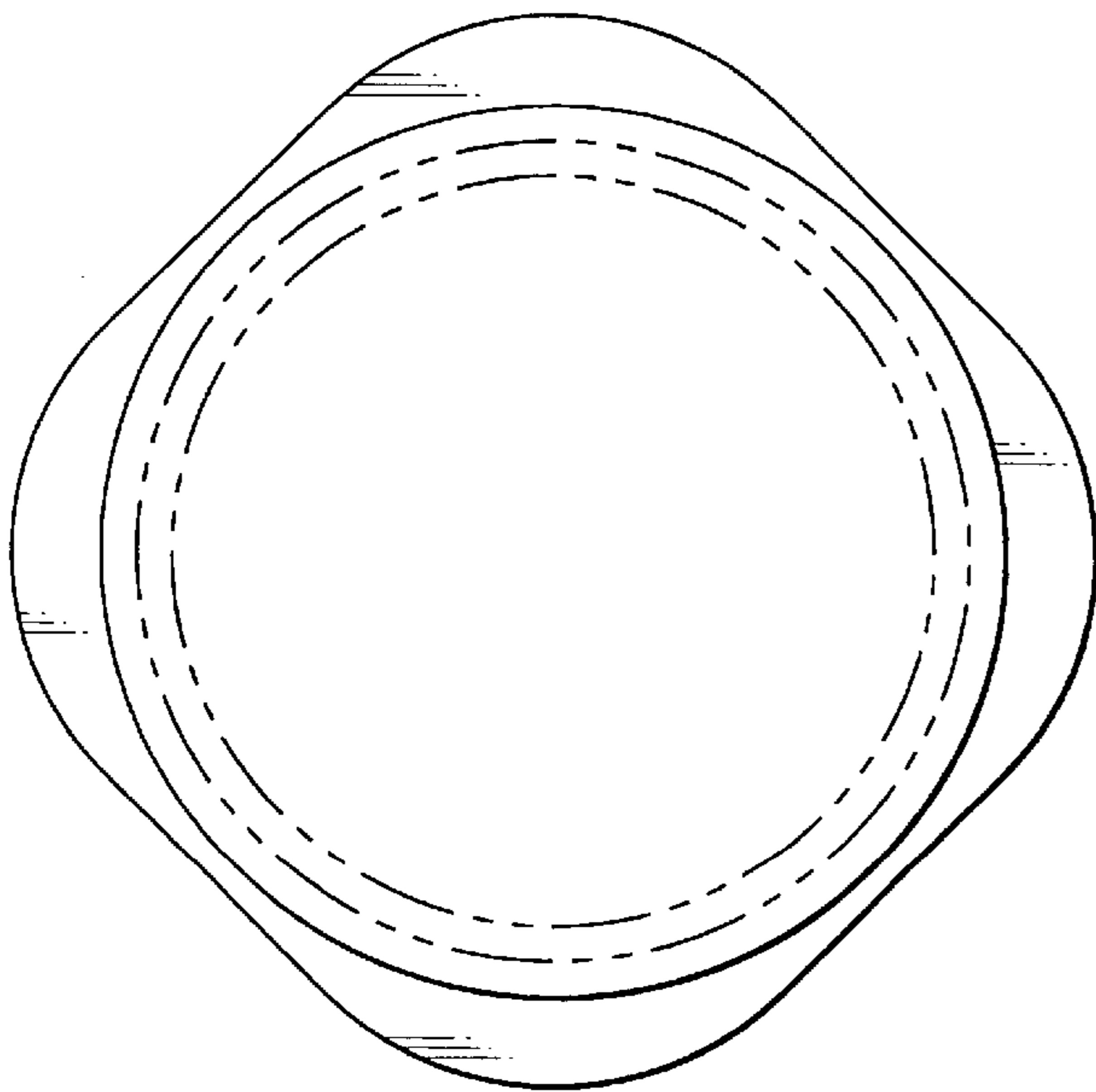
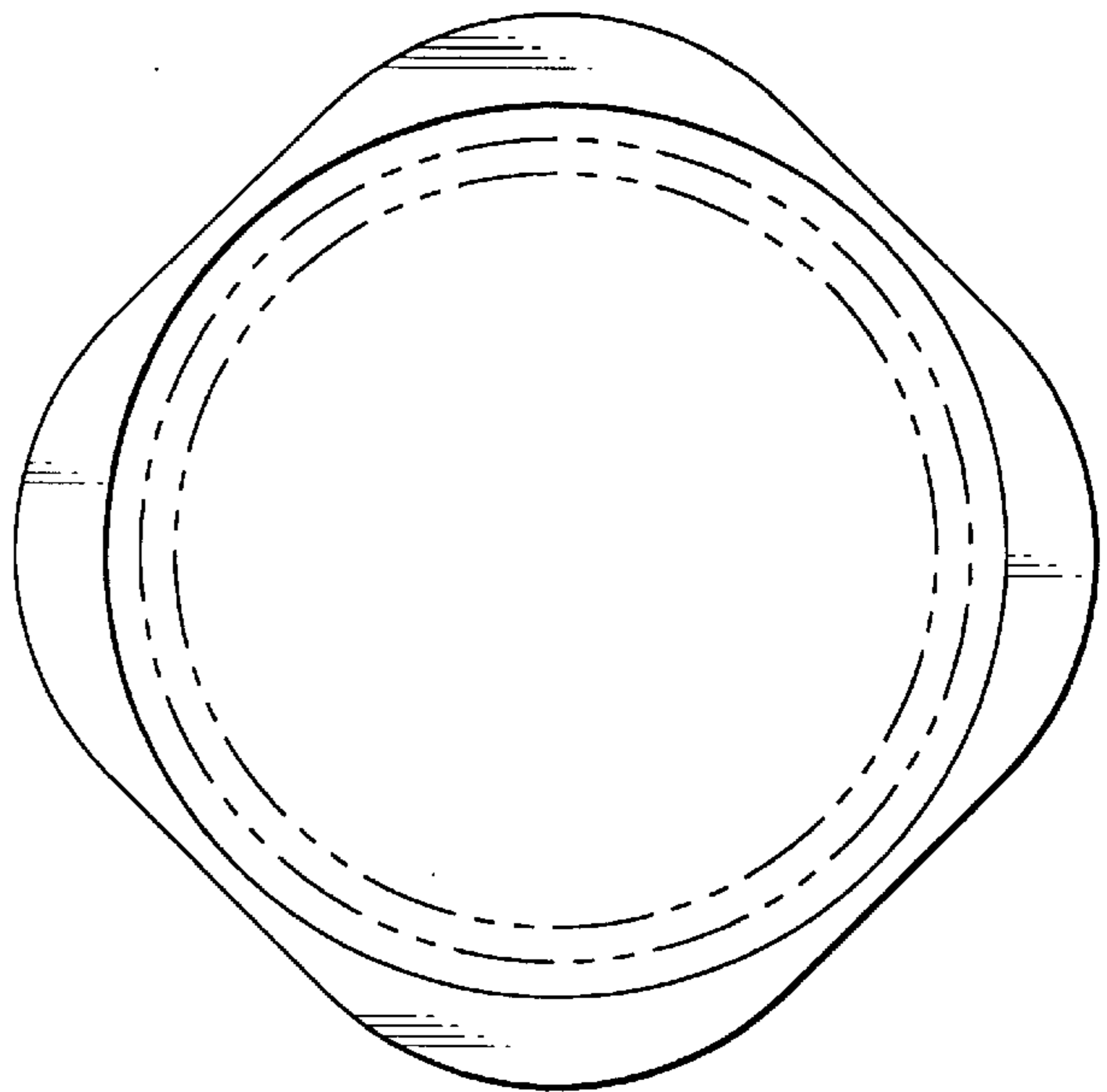

FIG. 13

FIG. 14

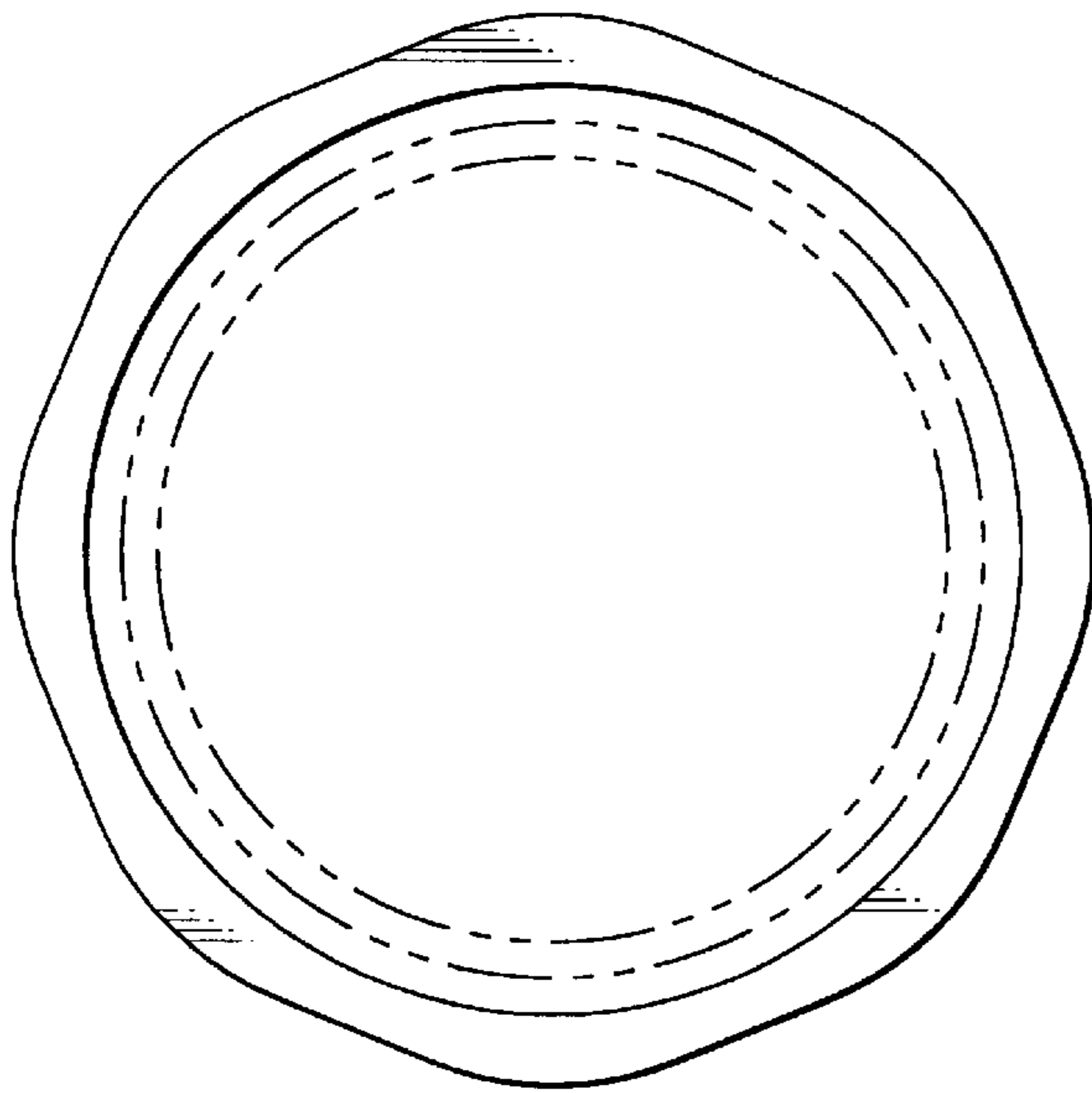
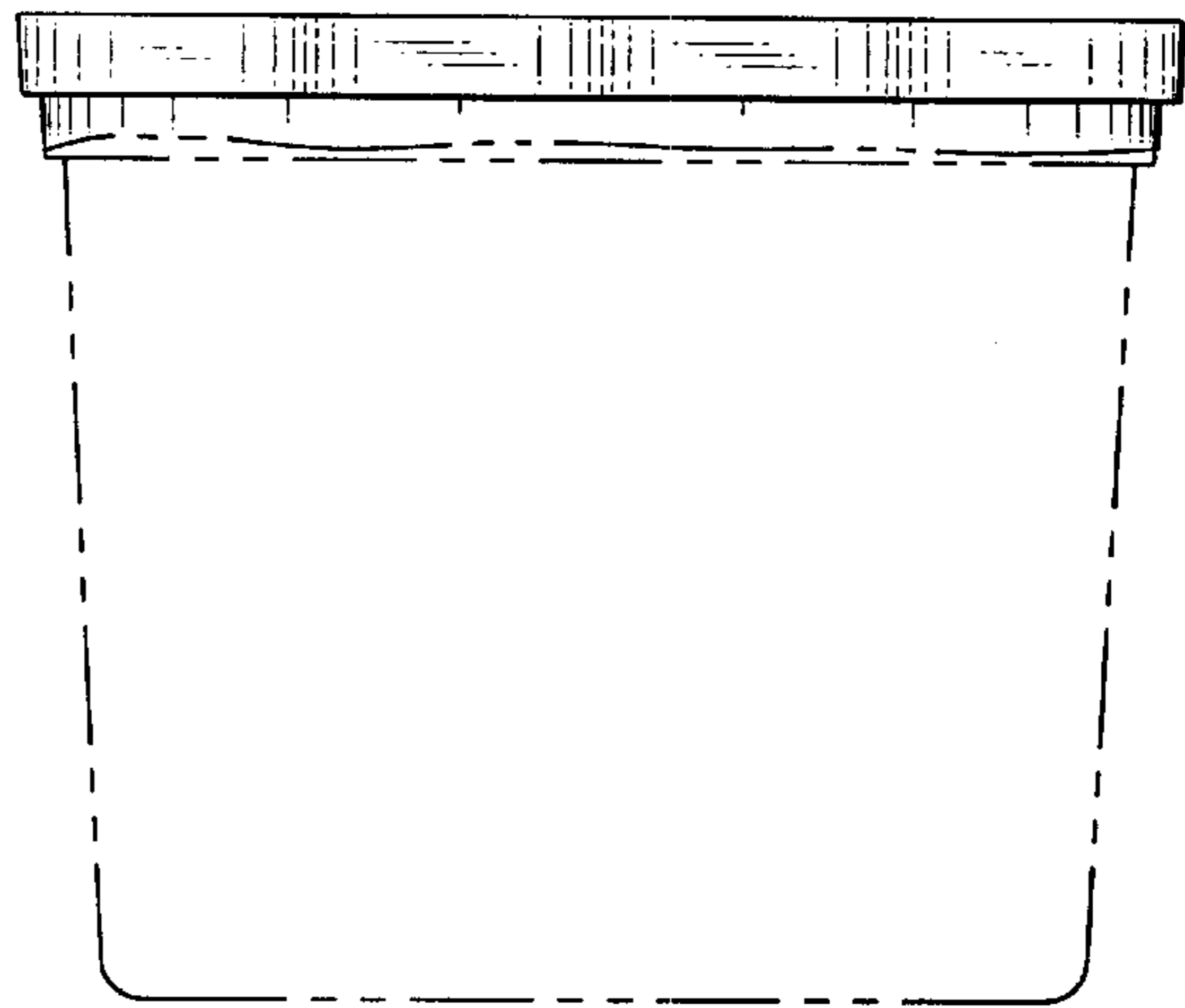

FIG. 15

FIG. 16

