



US00D413771S

**United States Patent** [19]  
**So**

[11] **Patent Number: Des. 413,771**

[45] **Date of Patent: \*\* Sep. 14, 1999**

[54] **CUTTER**

D. 154,071 6/1949 Smith ..... D7/673  
D. 287,452 12/1986 Stern ..... D7/673  
1,466,114 8/1923 Buchi ..... 30/302

[76] Inventor: **Kwok Kuen So**, Hse. No. 93,  
Sunderland Town House, No. 1  
Hereford Road, Kowloon Tong,  
Kowloon, The Hong Kong Special  
Administrative Region of the People's  
Republic of China

*Primary Examiner*—Terry A. Wallace  
*Attorney, Agent, or Firm*—Jenkins & Gilchrist, P.C.

[\*\*] Term: **14 Years**

[57] **CLAIM**

The ornamental design for a cutter, as shown and described.

[21] Appl. No.: **29/093,924**

**DESCRIPTION**

[22] Filed: **Sep. 22, 1998**

FIG. 1 is a perspective view from above of a cutter showing my new design;

[30] **Foreign Application Priority Data**

Mar. 26, 1998 [GB] United Kingdom ..... 2073507

FIG. 2 is an exploded perspective view thereof from above, showing a blade part separated;

[51] **LOC (6) Cl.** ..... **07-04**

[52] **U.S. Cl.** ..... **D7/673**

FIG. 3 is an end view thereof;

FIG. 4 is a top view thereof;

FIG. 5 is a side view thereof;

FIG. 6 is an opposing end view thereof;

FIG. 7 is a bottom view thereof; and,

FIG. 8 is an opposing side view thereof.

[58] **Field of Search** ..... D7/672, 673; 30/114,  
30/117, 302, 303, 312

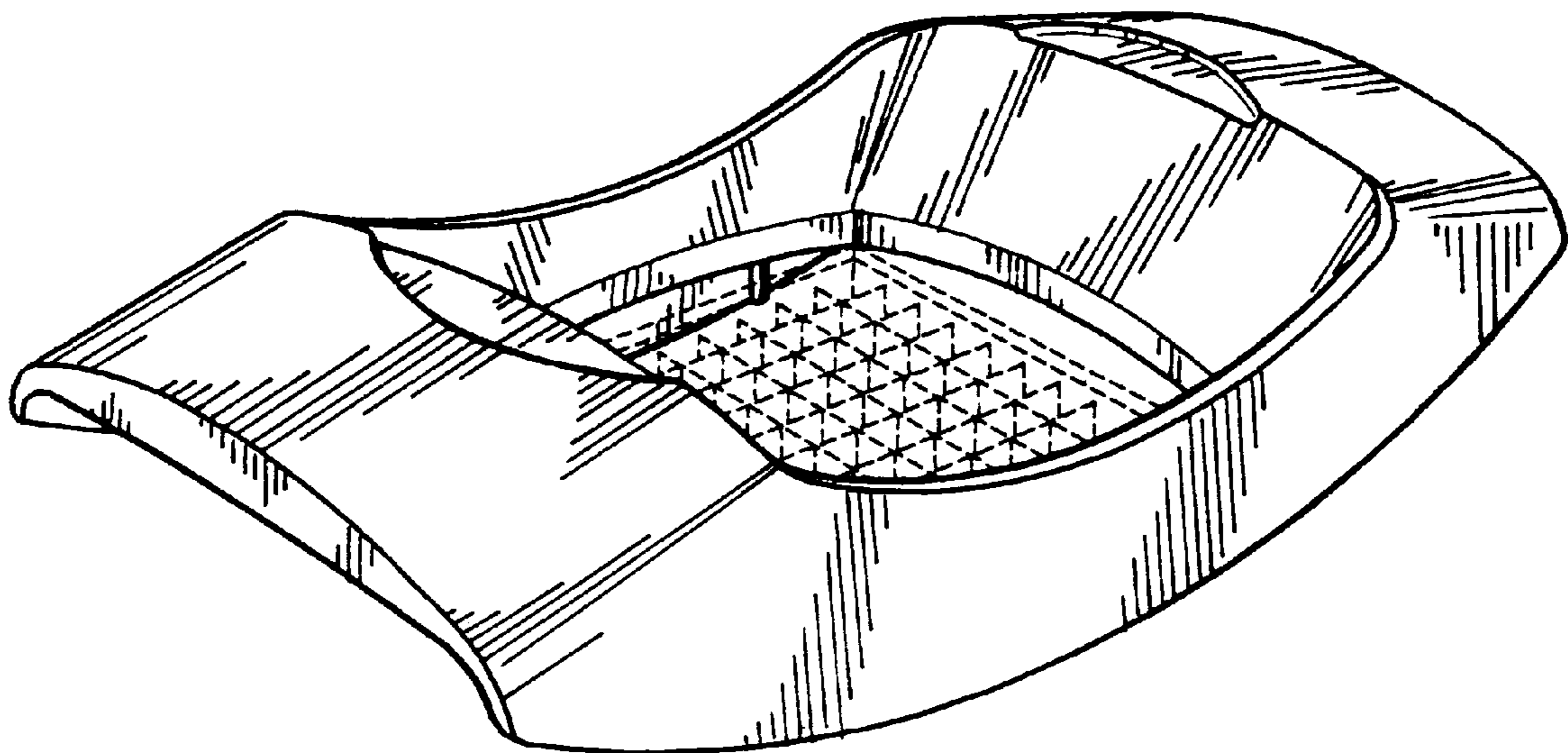
The broken lines show the environment in which the article is used and is not considered part of the design claimed.

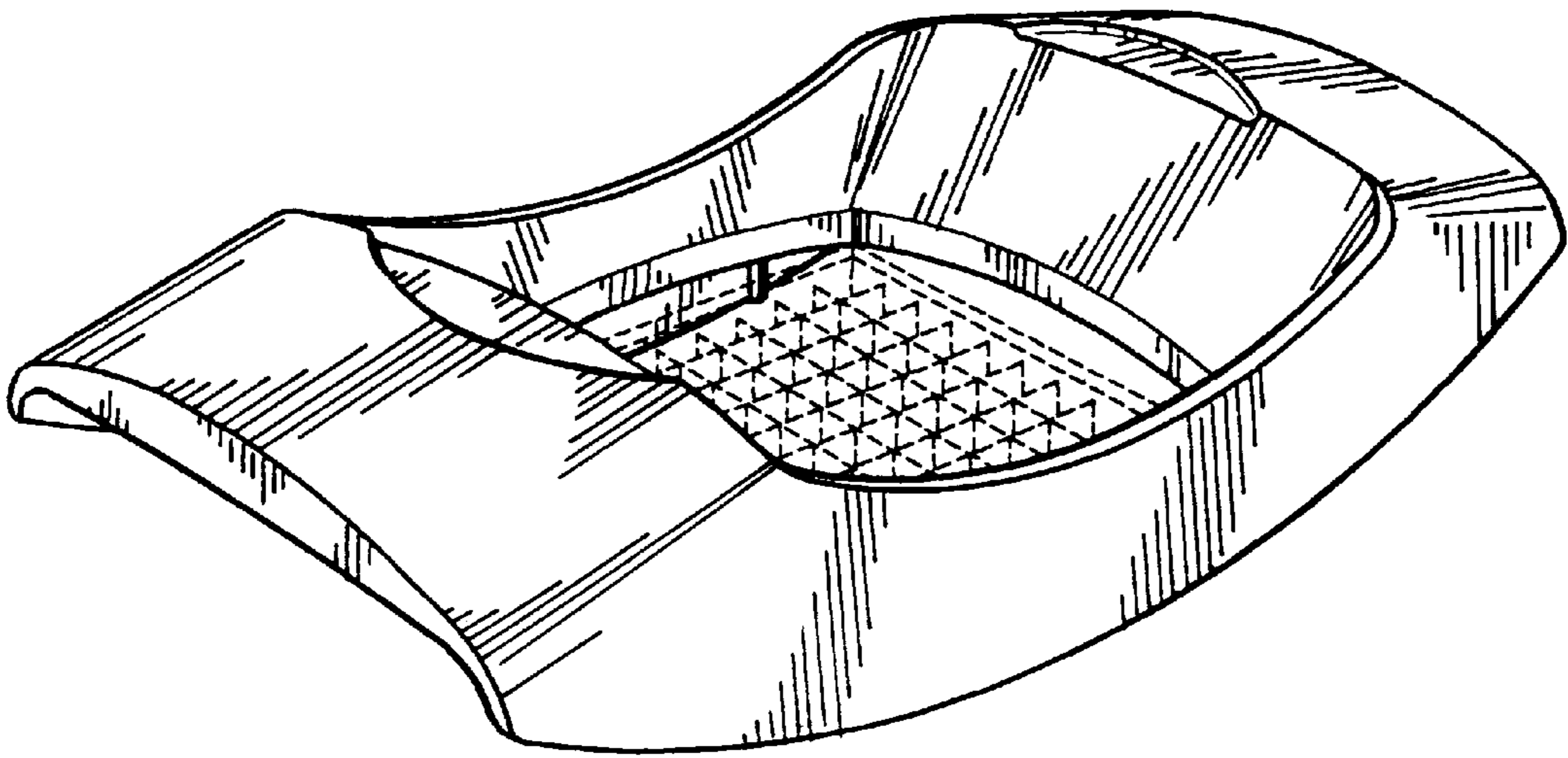
[56] **References Cited**

**U.S. PATENT DOCUMENTS**

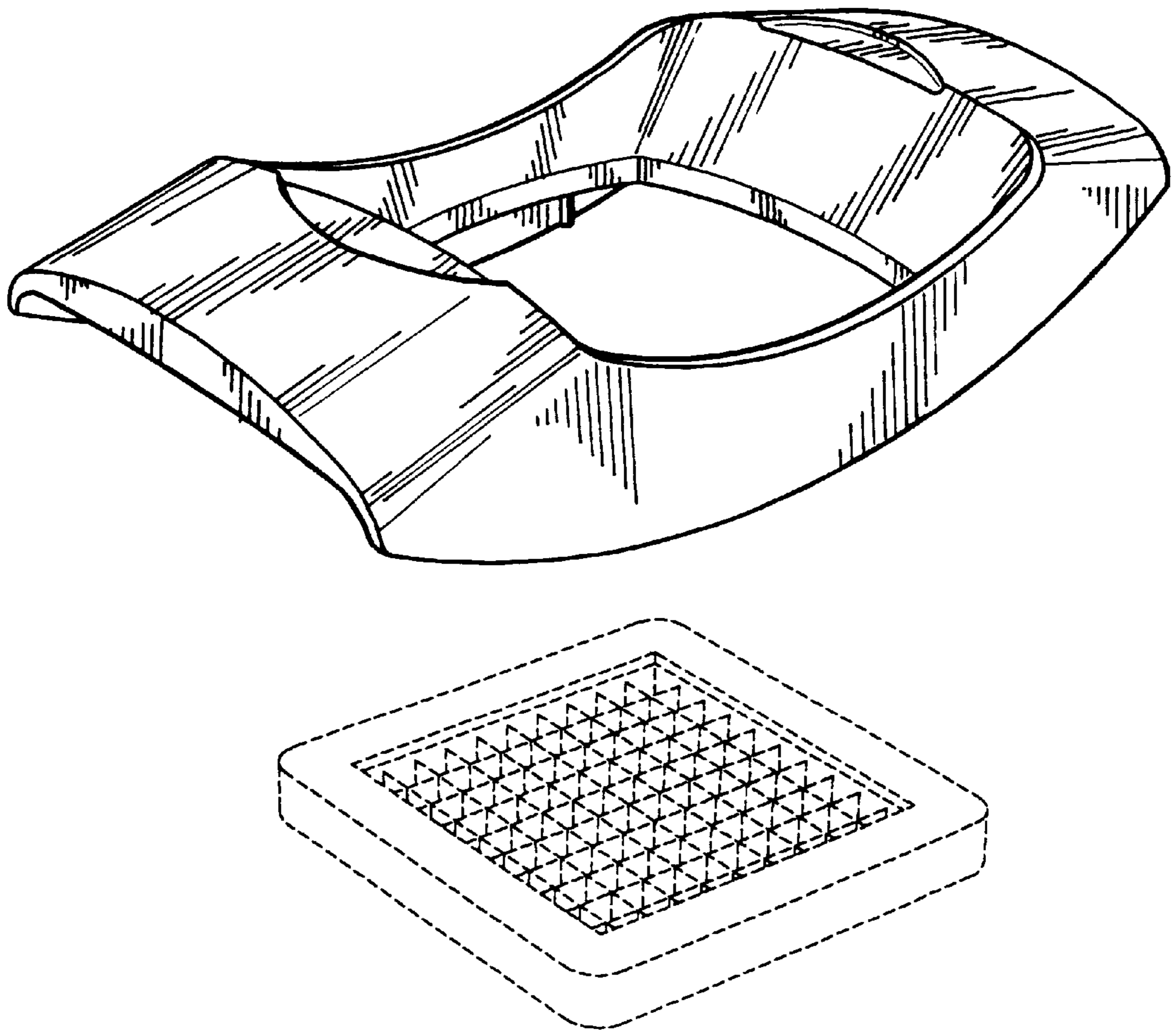
D. 147,401 9/1947 Cohen ..... D7/673

**1 Claim, 4 Drawing Sheets**

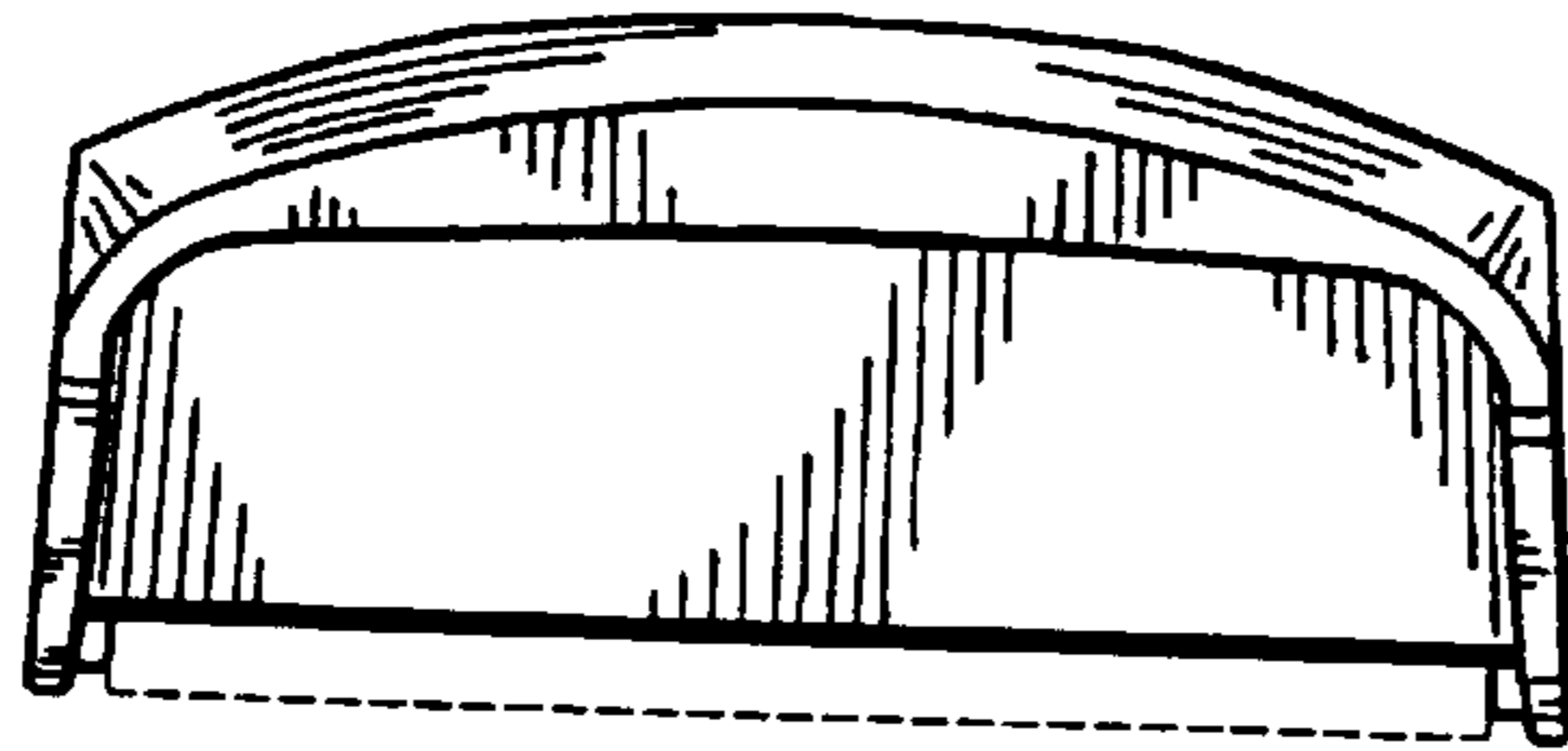




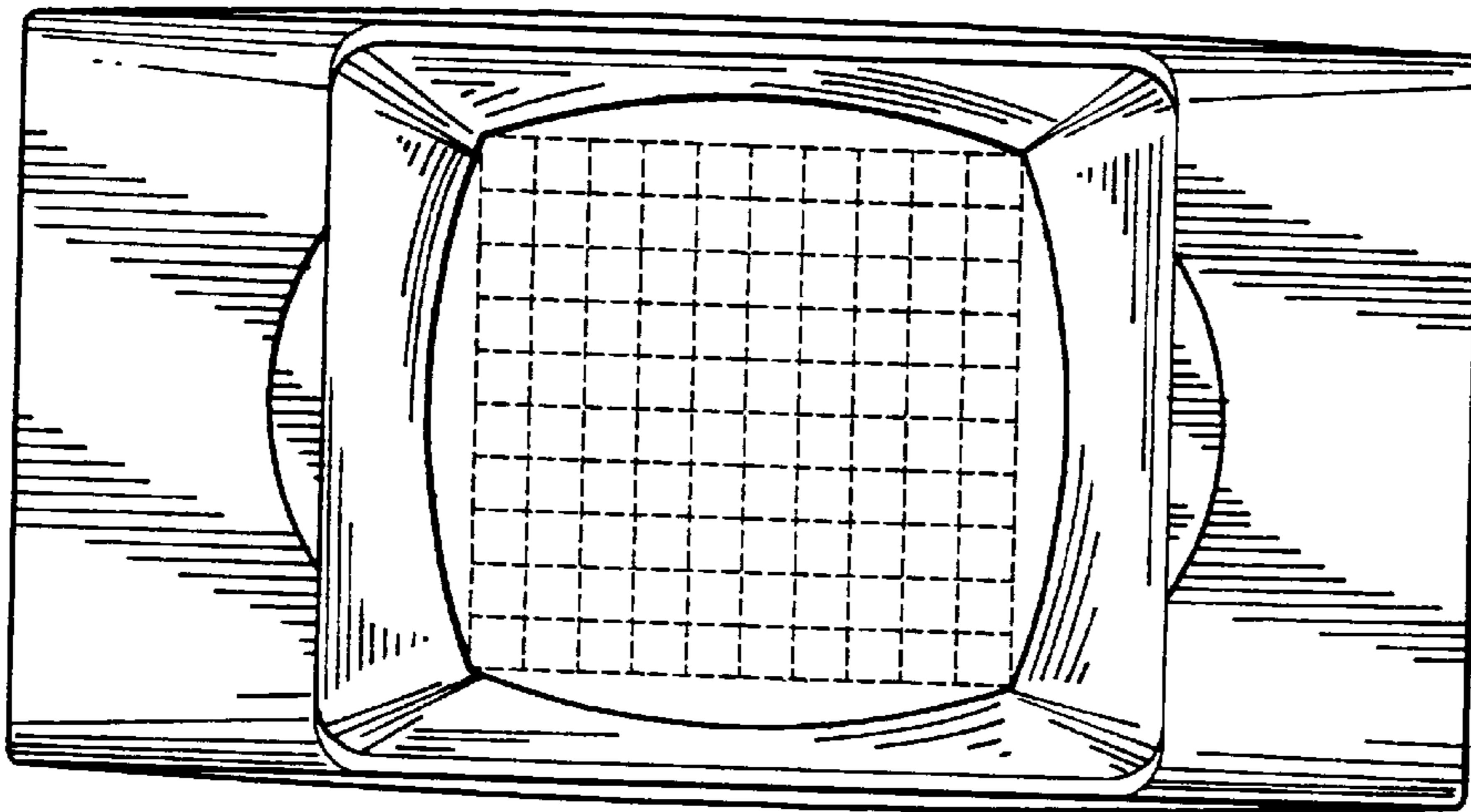
**FIG. 1**



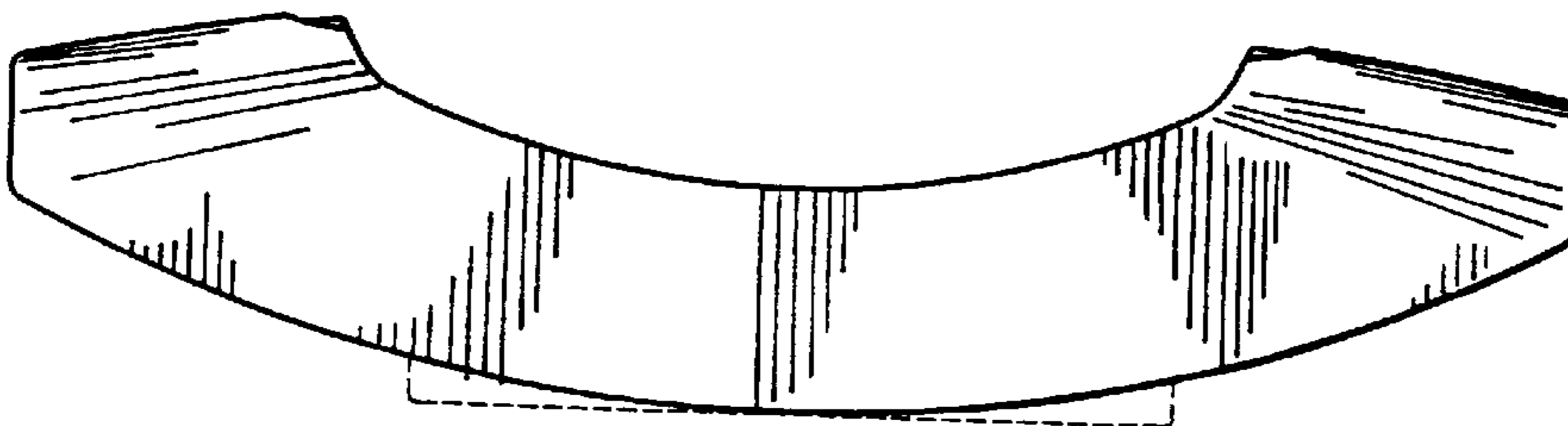
**FIG. 2**



**FIG. 3**



**FIG. 4**



**FIG. 5**

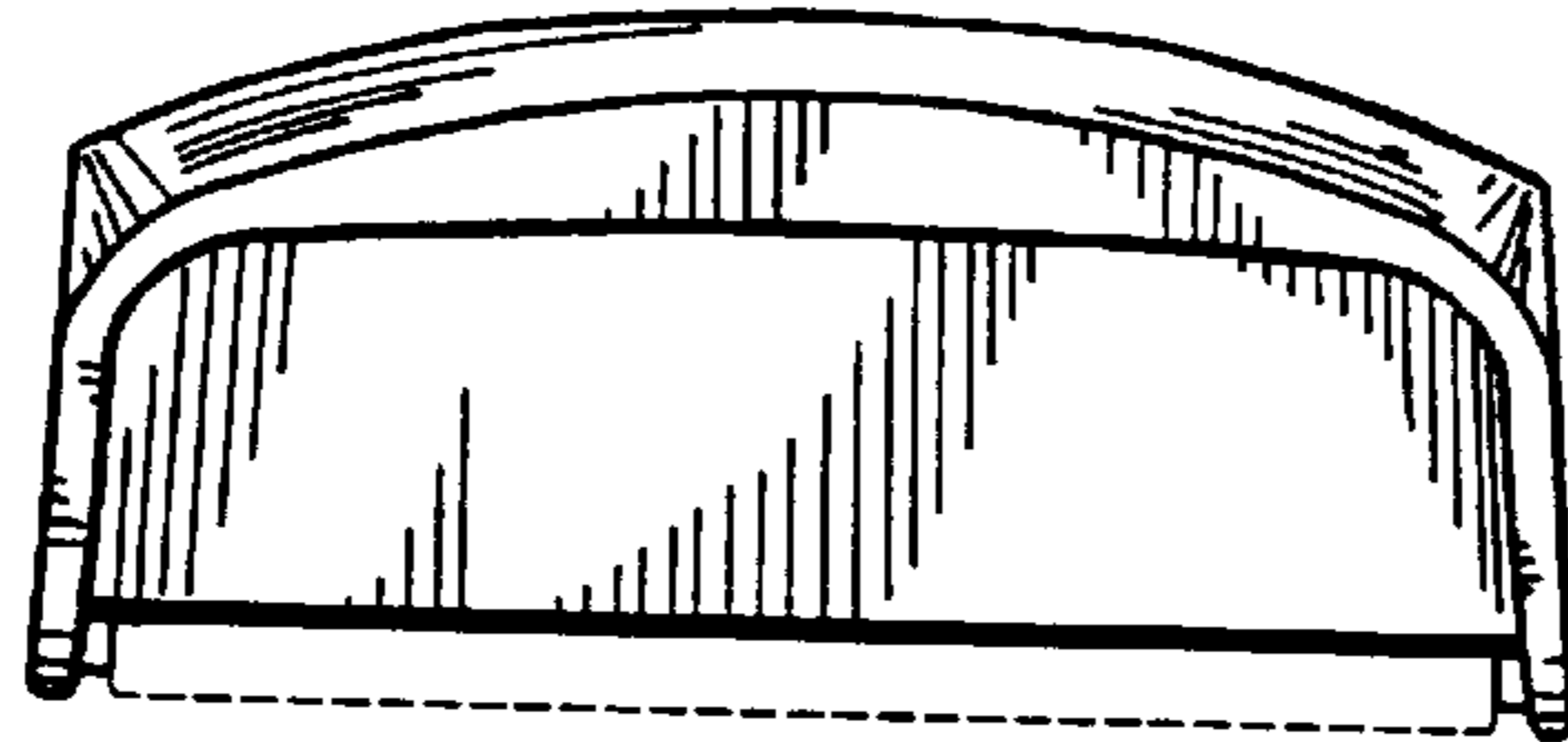


FIG. 6

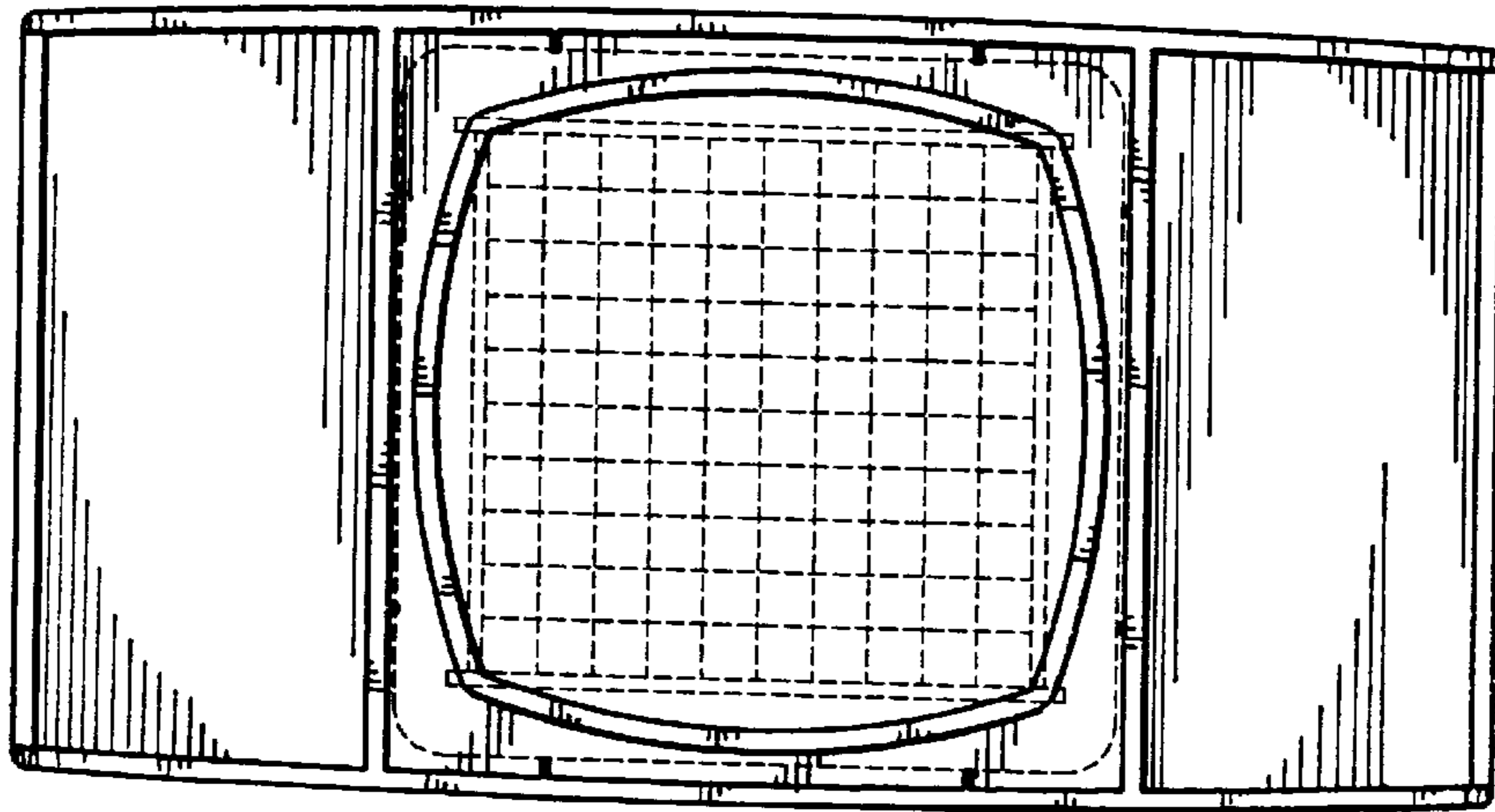


FIG. 7

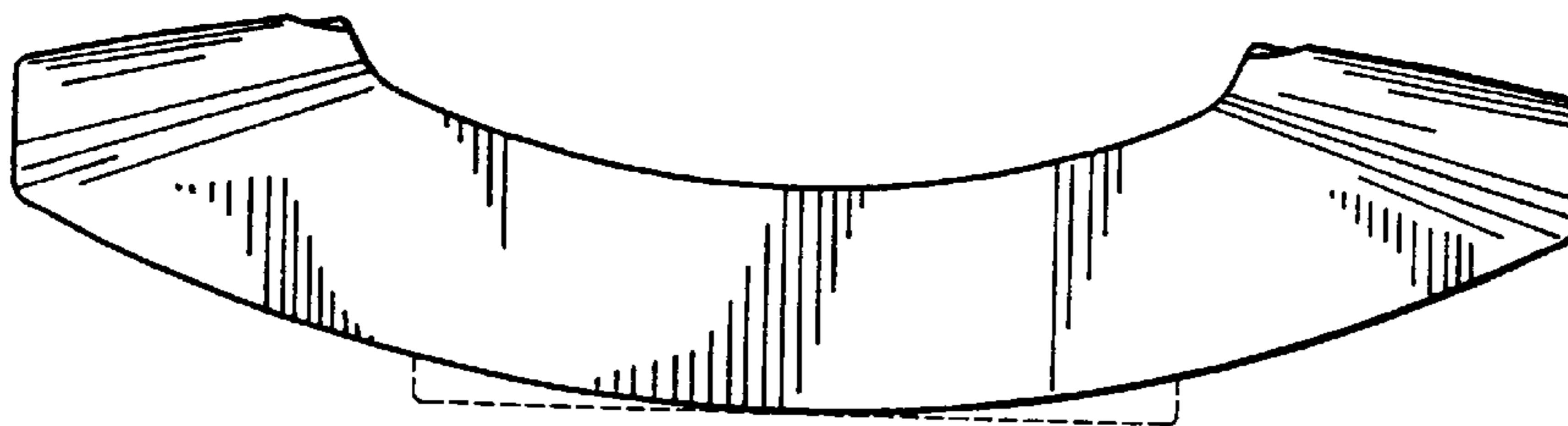


FIG. 8