



US00D413642S

United States Patent [19]

[11] Patent Number: Des. 413,642

Burrows

[45] Date of Patent: ** Sep. 7, 1999

[54] WOOD-TYPE HEAD FOR A GOLF CLUB

5,851,159 12/1998 Burrows 473/345

[76] Inventor: **Bruce D. Burrows**, 25555 W. Avenue
Stanford, Valencia, Calif. 91355-1101

Primary Examiner—Mitchell Siegel
Attorney, Agent, or Firm—Kelly Bauersfeld Lowry &
Kelley, LLP

[**] Term: 14 Years

[57] CLAIM

[21] Appl. No.: 29/090,918

The ornamental design for a wood-type head for a golf club,
as shown and described.

[22] Filed: Jul. 20, 1998

DESCRIPTION

[51] LOC (6) Cl. 21-02

[52] U.S. Cl. D21/752

[58] Field of Search D21/733, 752,
D21/753, 759; 473/324, 327-331, 343-346

FIG. 1 is a perspective view showing the front, top and left
sides of a wood-type head for a golf club embodying the new
design;

FIG. 2 is a front elevational view thereof;

FIG. 3 is a left side elevational view thereof;

FIG. 4 is a right side elevational view thereof;

FIG. 5 is a rear elevational view thereof;

FIG. 6 is a top plan view thereof;

FIG. 7 is a bottom plan view thereof;

FIG. 8 is a bottom plan view of an alternative form of my
new design, the front and rear elevational views, the top plan
view, and the right side elevational view being identical to
the embodiment of FIGS. 1-7; and,

FIG. 9 is a left side elevational view of the embodiment of
FIG. 8.

The broken line showing of a fragmented shaft is for
illustrative purposes only and forms no part of the claimed
design.

[56] References Cited

U.S. PATENT DOCUMENTS

D. 318,087	7/1991	Helmstetter .	
D. 354,103	1/1995	Allen .	
D. 356,356	3/1995	Jacobs .	
D. 364,666	11/1995	Nagy .	
D. 366,919	2/1996	Jacobs .	
D. 385,003	10/1997	Burrows	D21/752
D. 390,294	2/1998	Burrows	D21/752
D. 390,295	2/1998	Burrows	D21/752
D. 392,354	3/1998	Burrows	D21/752
D. 397,749	9/1998	Burrows	D21/752
D. 401,299	11/1998	Burrows	D21/733
1,541,126	6/1925	Dunn .	
1,588,617	6/1926	Rose	473/324
3,374,027	3/1968	Jacobs .	

1 Claim, 5 Drawing Sheets

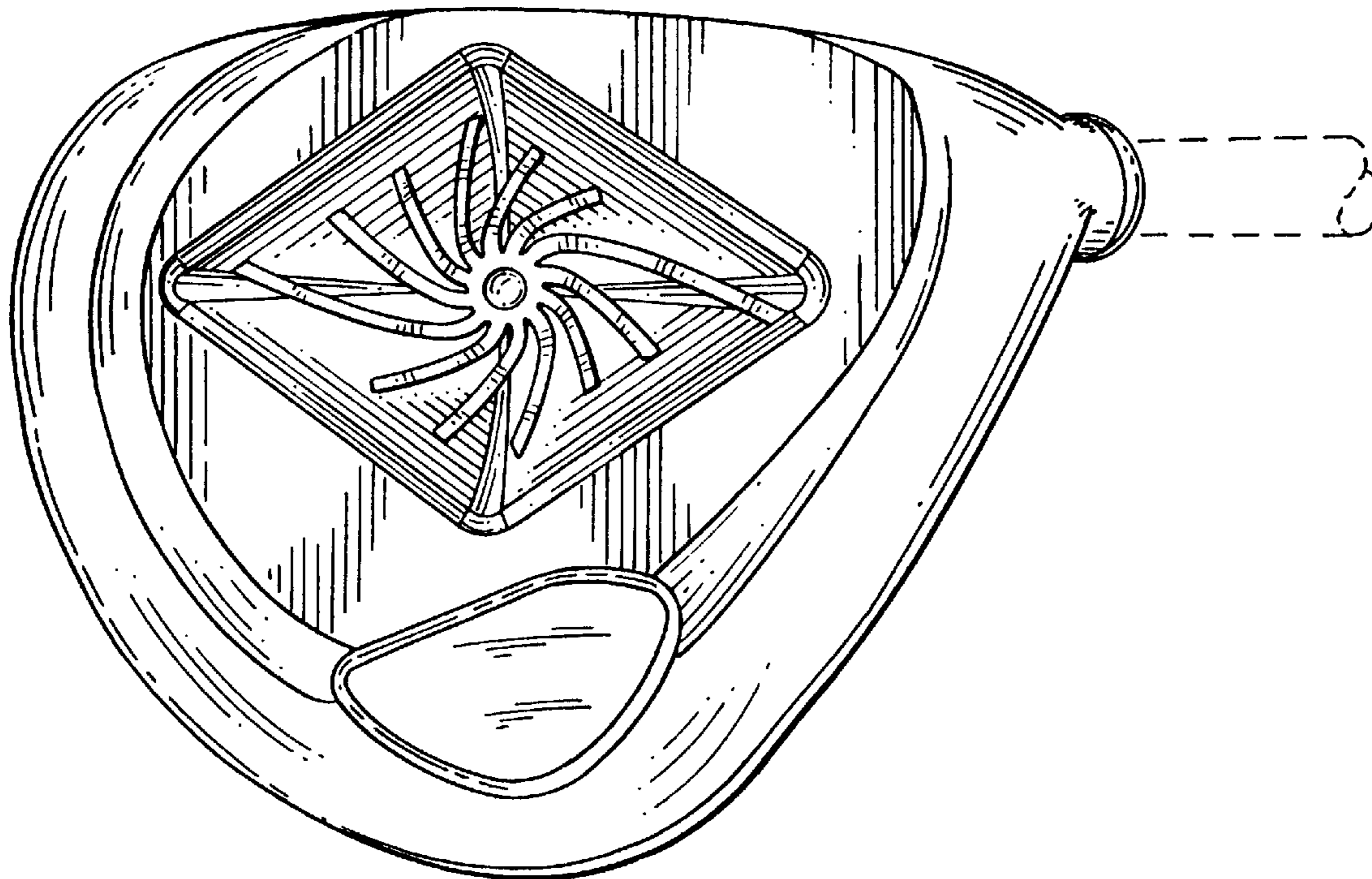

FIG. 1

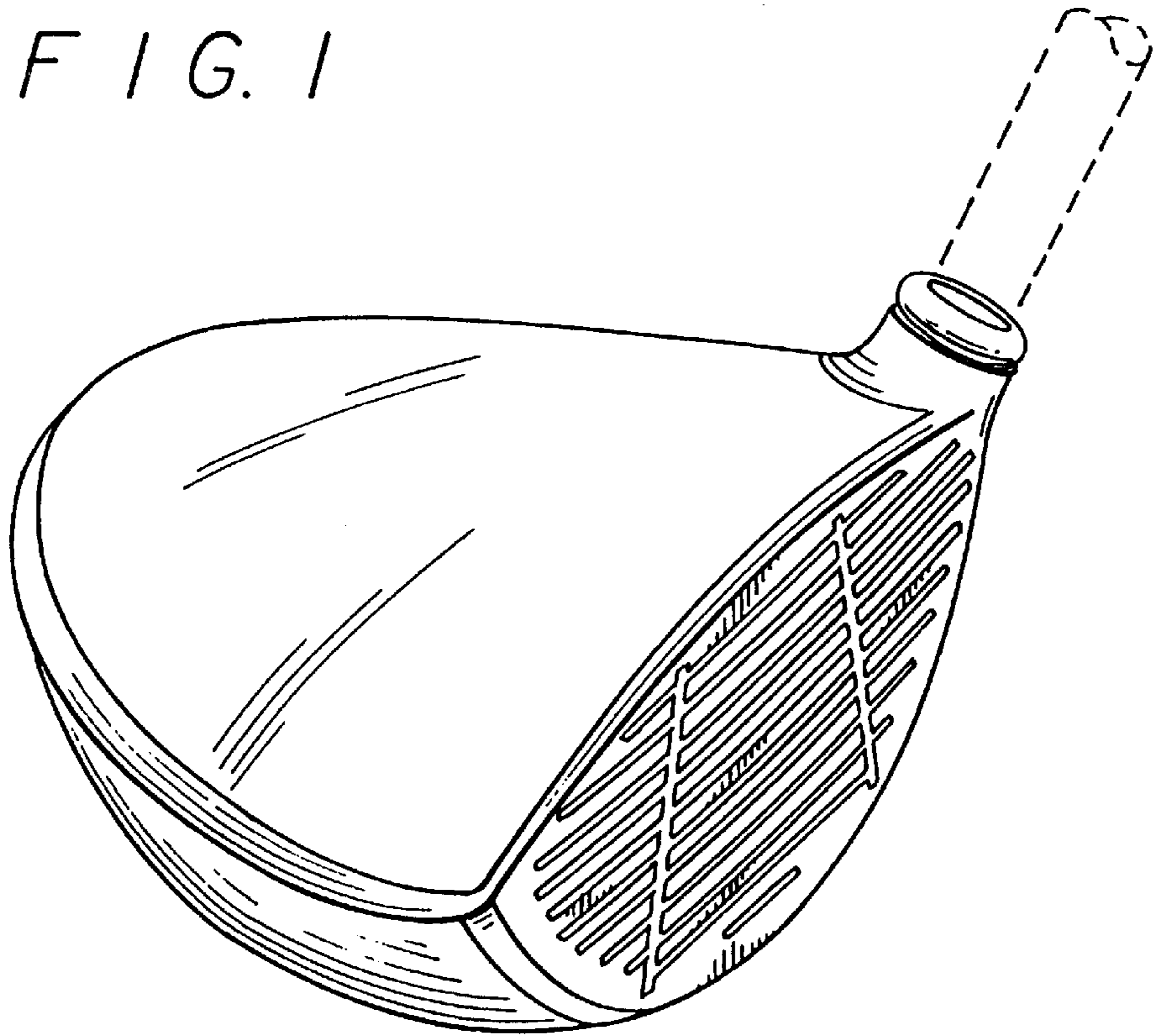

FIG. 2

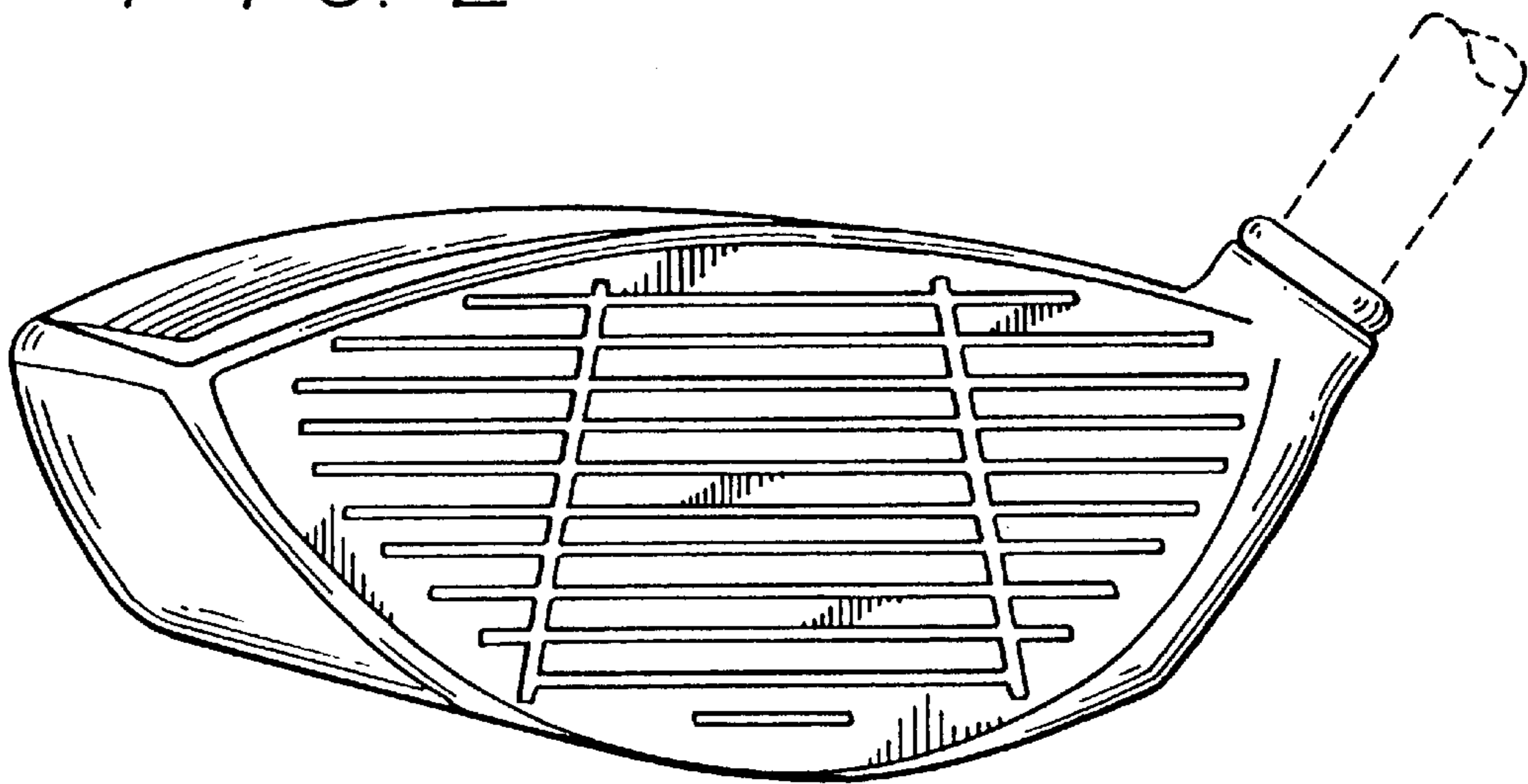

FIG. 3

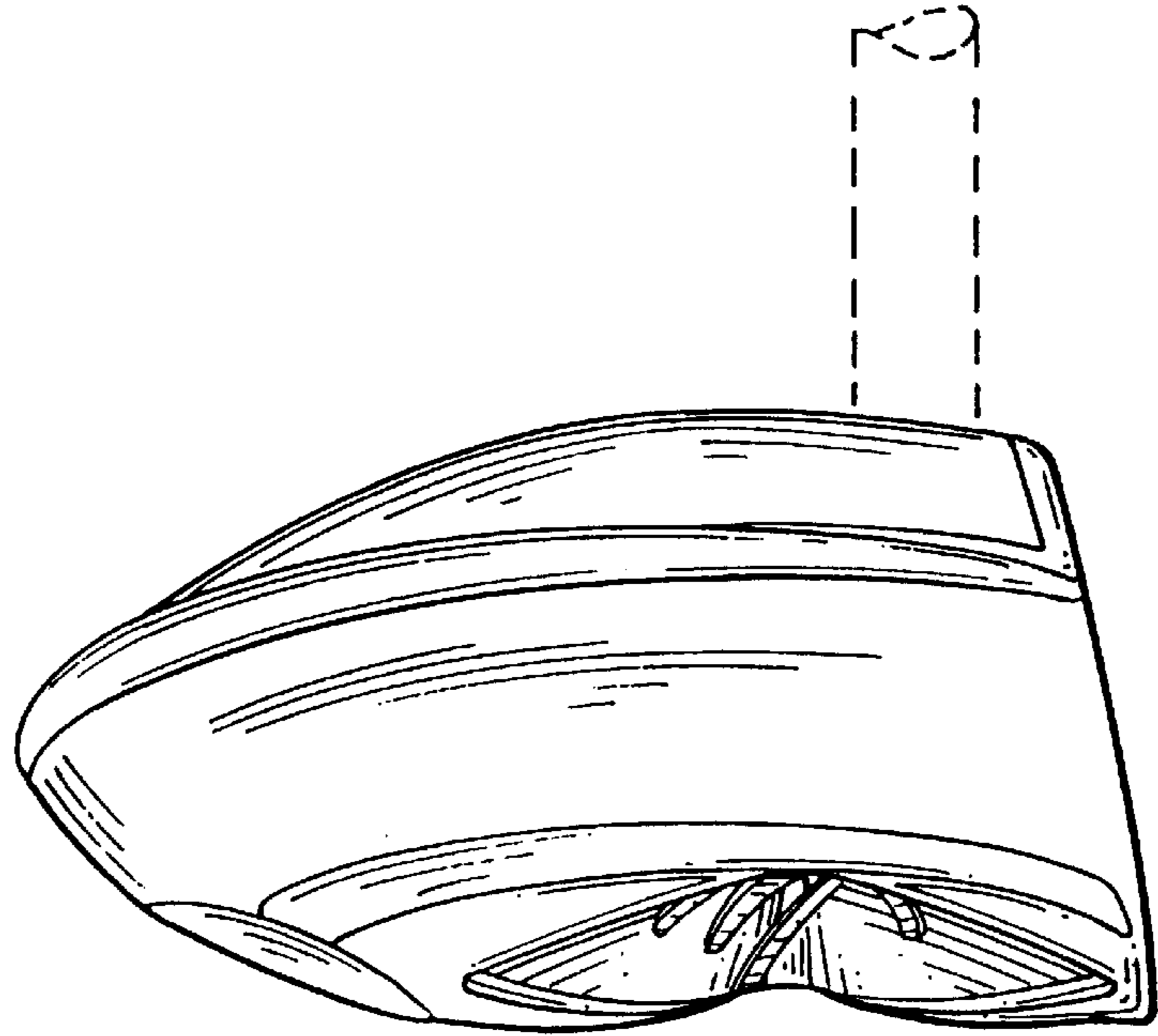

FIG. 4

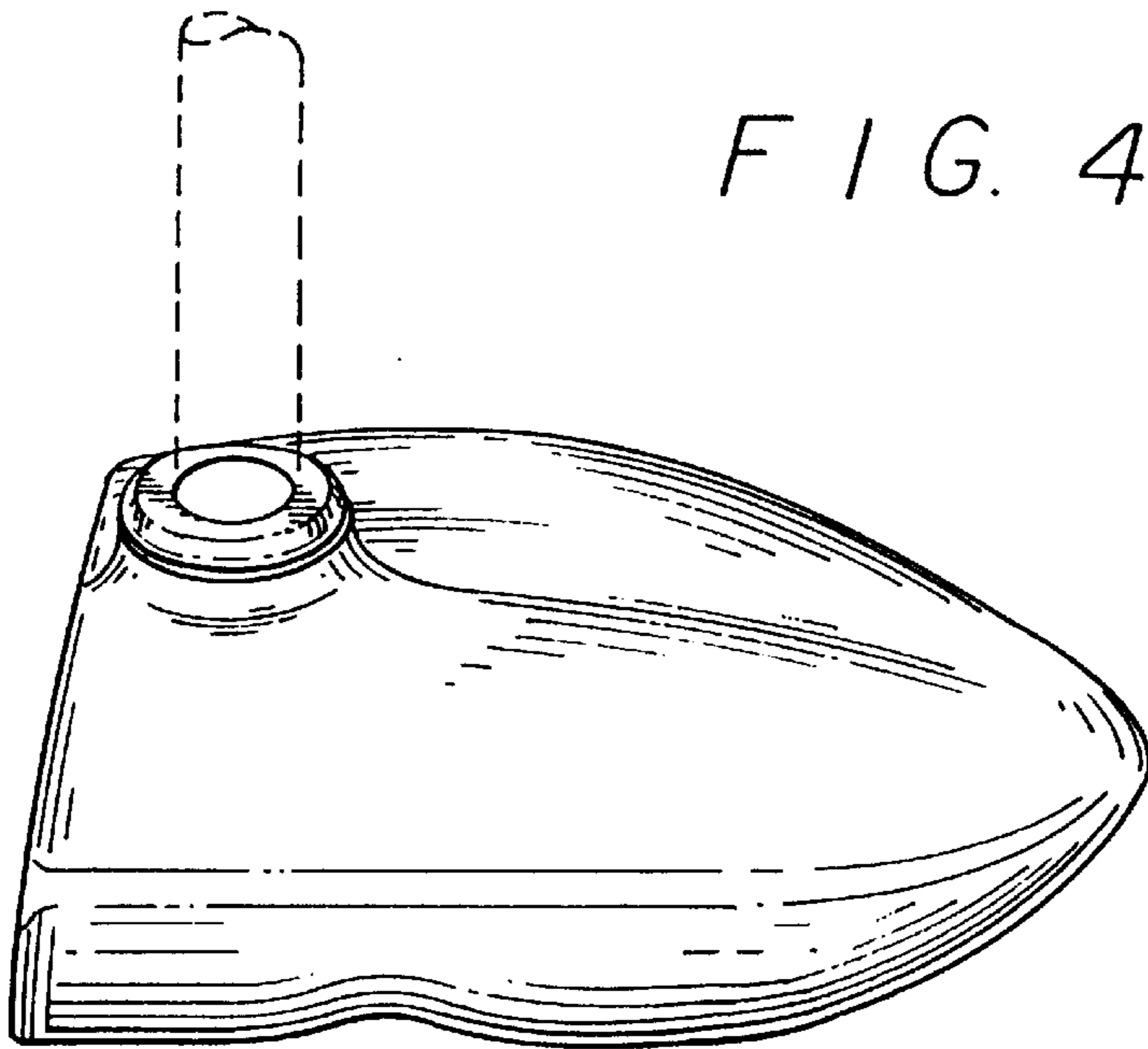

FIG. 5

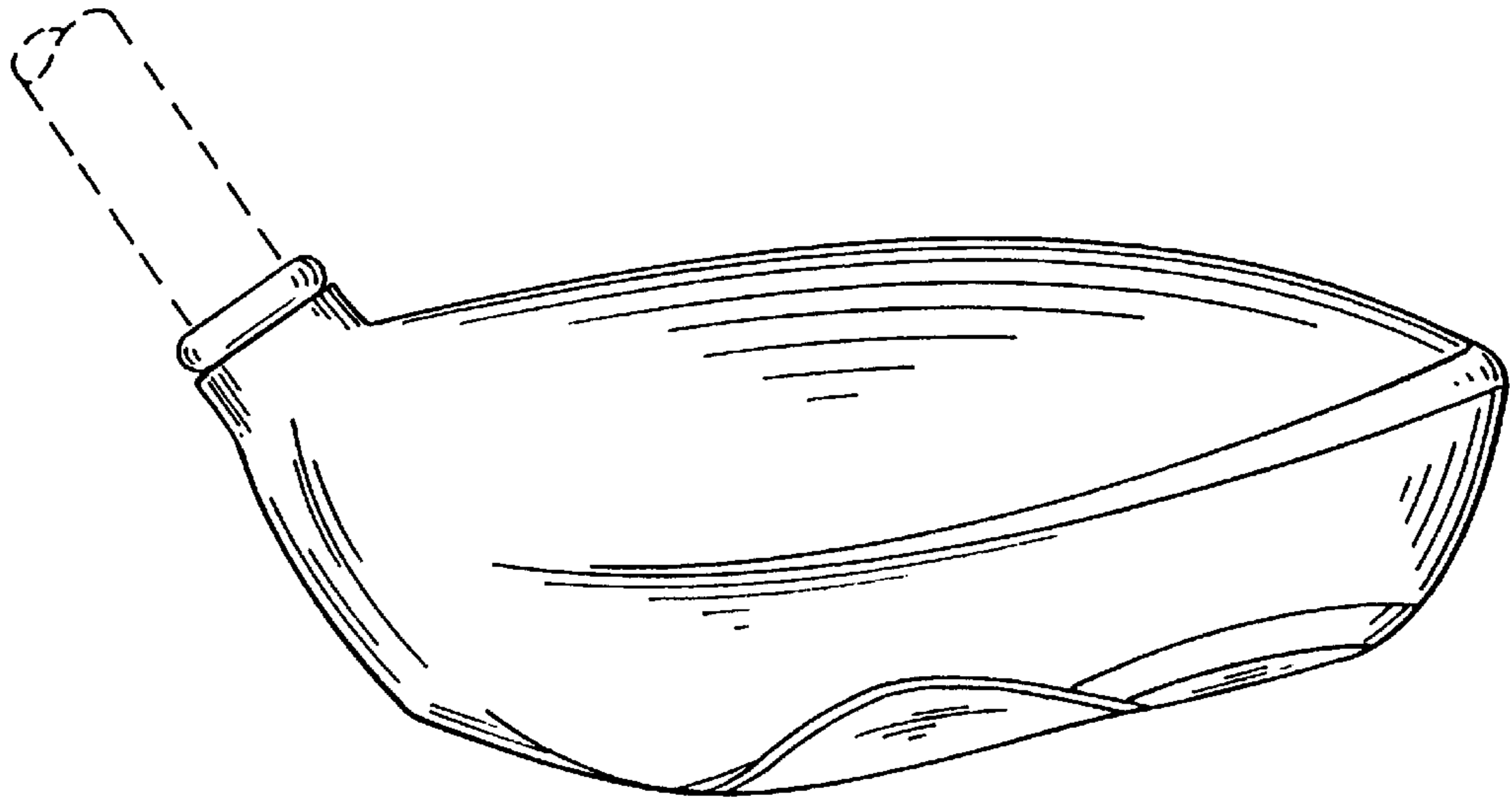
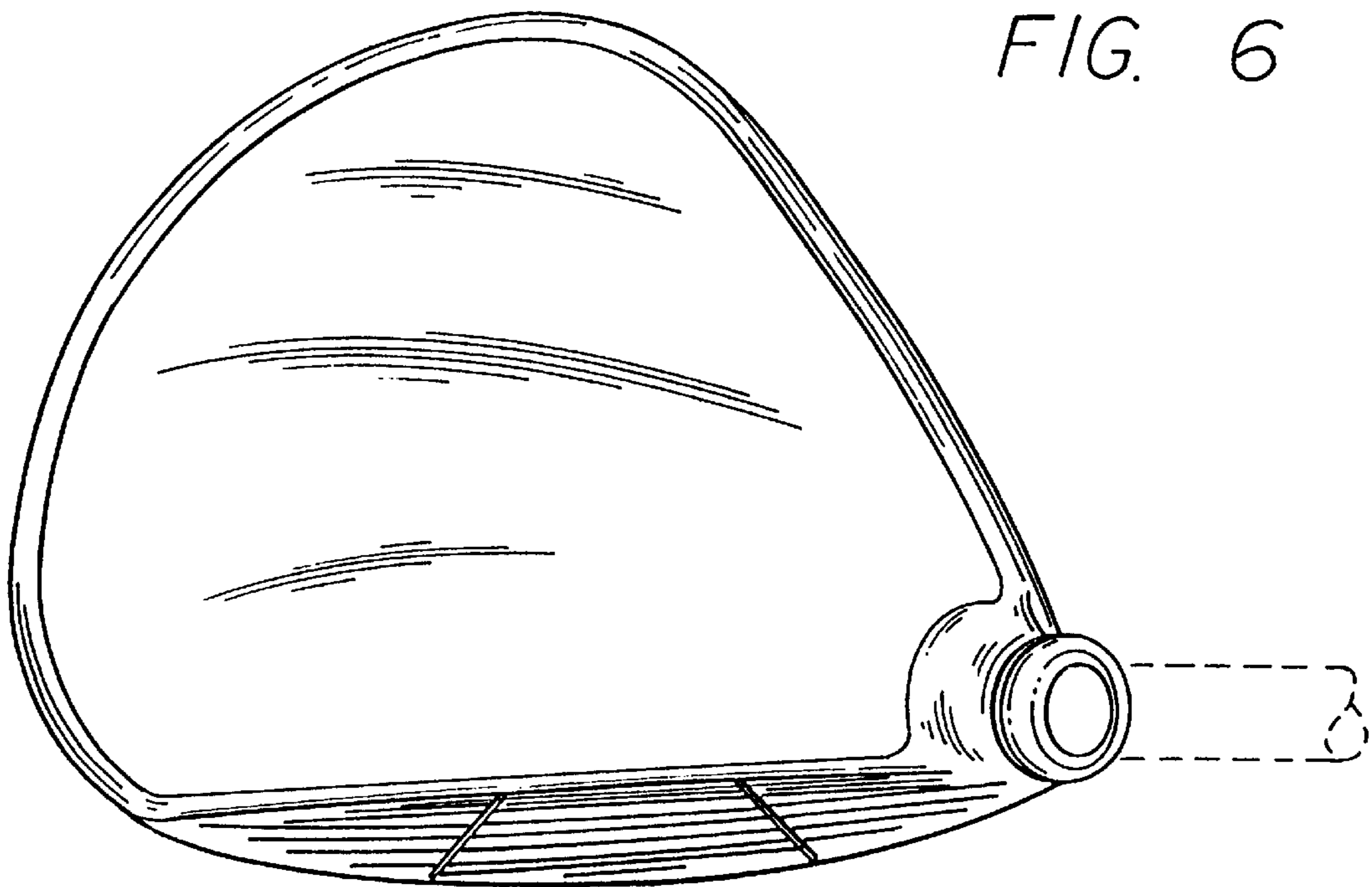

FIG. 6



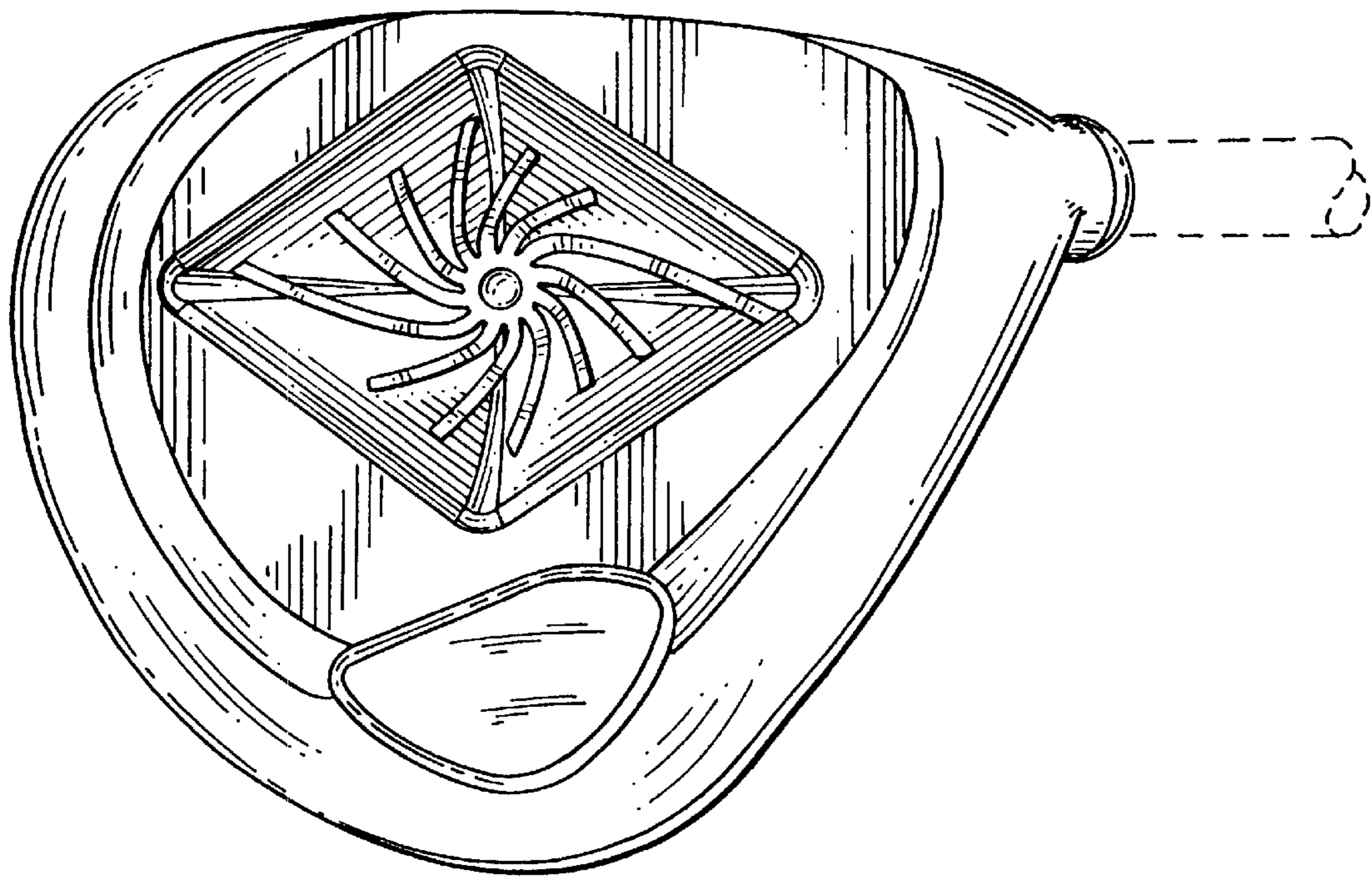

FIG. 7

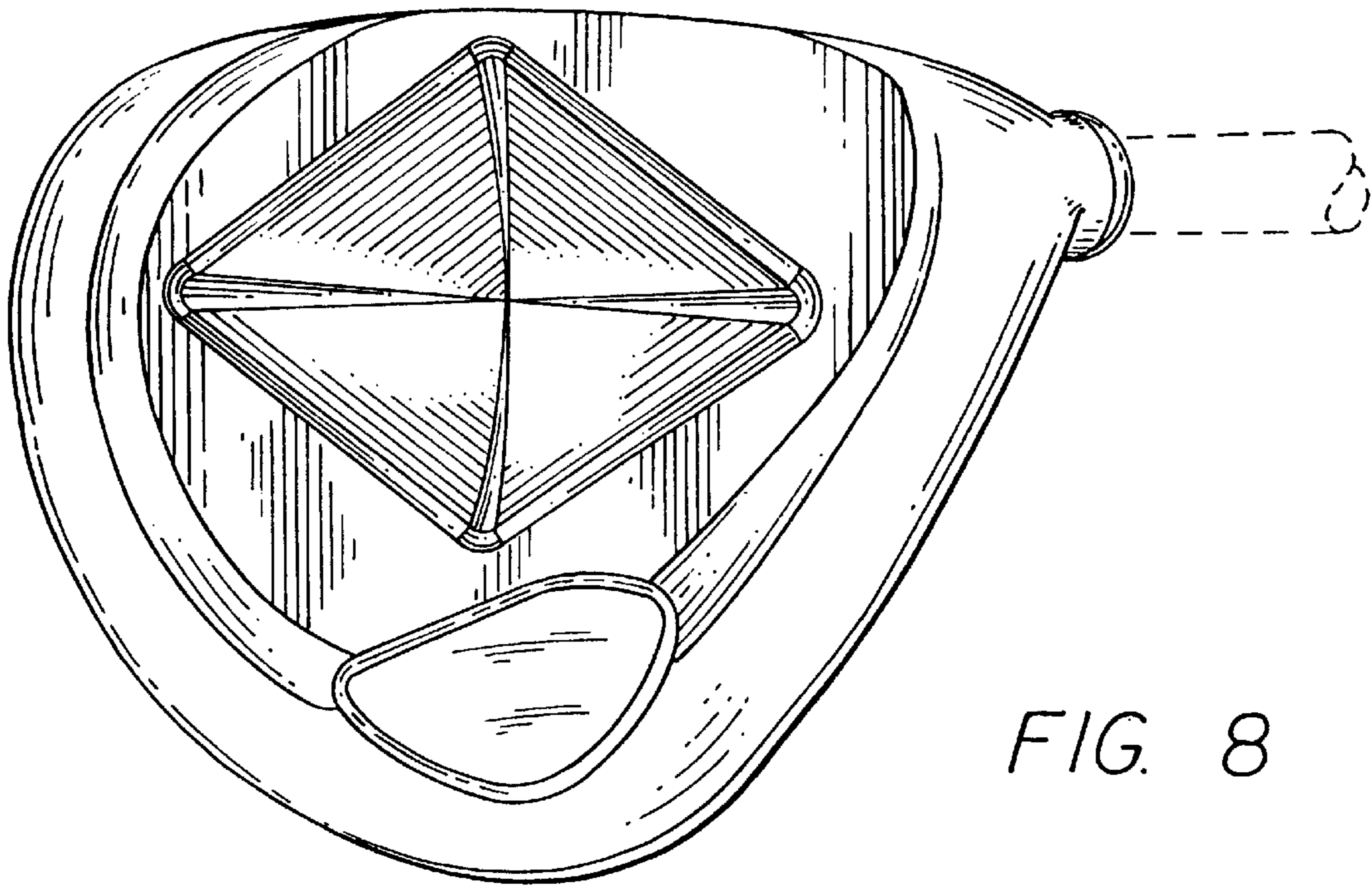

FIG. 8

FIG. 9

