



US00D413565S

United States Patent [19]
Nakayama

[11] **Patent Number: Des. 413,565**

[45] **Date of Patent: ** Sep. 7, 1999**

[54] **BATTERY**

[75] Inventor: **Miya Nakayama**, Tokyo, Japan

[73] Assignee: **Sony Corporation**, Tokyo, Japan

[**] Term: **14 Years**

[21] Appl. No.: **29/093,248**

[22] Filed: **Sep. 8, 1998**

[30] **Foreign Application Priority Data**

Mar. 6, 1998 [JP] Japan 10-6105

[51] **LOC (6) Cl.** **13-02**

[52] **U.S. Cl.** **D13/103**

[58] **Field of Search** D13/103; 429/96-100,
429/66, 76; D7/523; D11/152, 170

[56] **References Cited**

U.S. PATENT DOCUMENTS

D. 388,051	12/1997	Harada et al.	D13/103
D. 392,249	3/1998	Nakazawa et al.	D13/103
D. 403,297	12/1998	Nakazawa	D13/103
5,501,917	3/1996	Hong	429/97 X
5,532,080	7/1996	Mizoguchi et al.	429/98 X

OTHER PUBLICATIONS

Sony Catalog, "86", FD Trinitron WEGA, pp. 291-293, (Jul. 1997).

Primary Examiner—Joel Sincavage

Attorney, Agent, or Firm—Foley & Lardner

[57] **CLAIM**

The ornamental design for a battery, as shown and described.

DESCRIPTION

FIG. 1 is a perspective view of a first embodiment of a battery showing my new design;

FIG. 2 is a top plan view thereof;

FIG. 3 is a left side elevational view thereof;

FIG. 4 is a front elevational view thereof;

FIG. 5 is a bottom plan view thereof;

FIG. 6 is a right side elevational view thereof; and

FIG. 7 is a rear elevational view thereof.

FIG. 8 is a perspective view of a second embodiment of a battery showing my new design;

FIG. 9 is a top plan view thereof;

FIG. 10 is a left side elevational view thereof;

FIG. 11 is a front elevational view thereof;

FIG. 12 is a bottom plan view thereof;

FIG. 13 is a right side elevational view thereof; and,

FIG. 14 is a rear elevational view thereof.

1 Claim, 6 Drawing Sheets

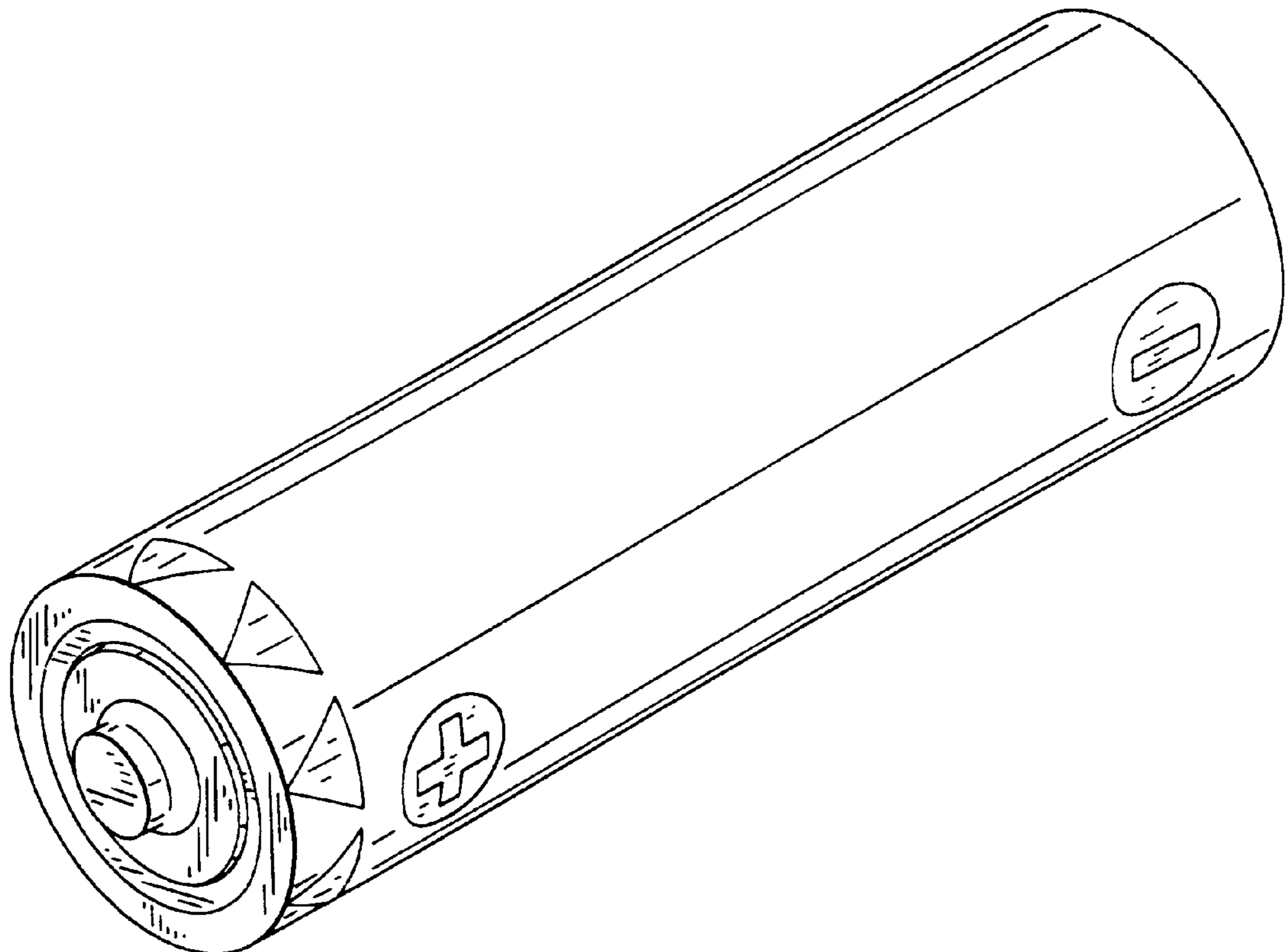

FIG. 1

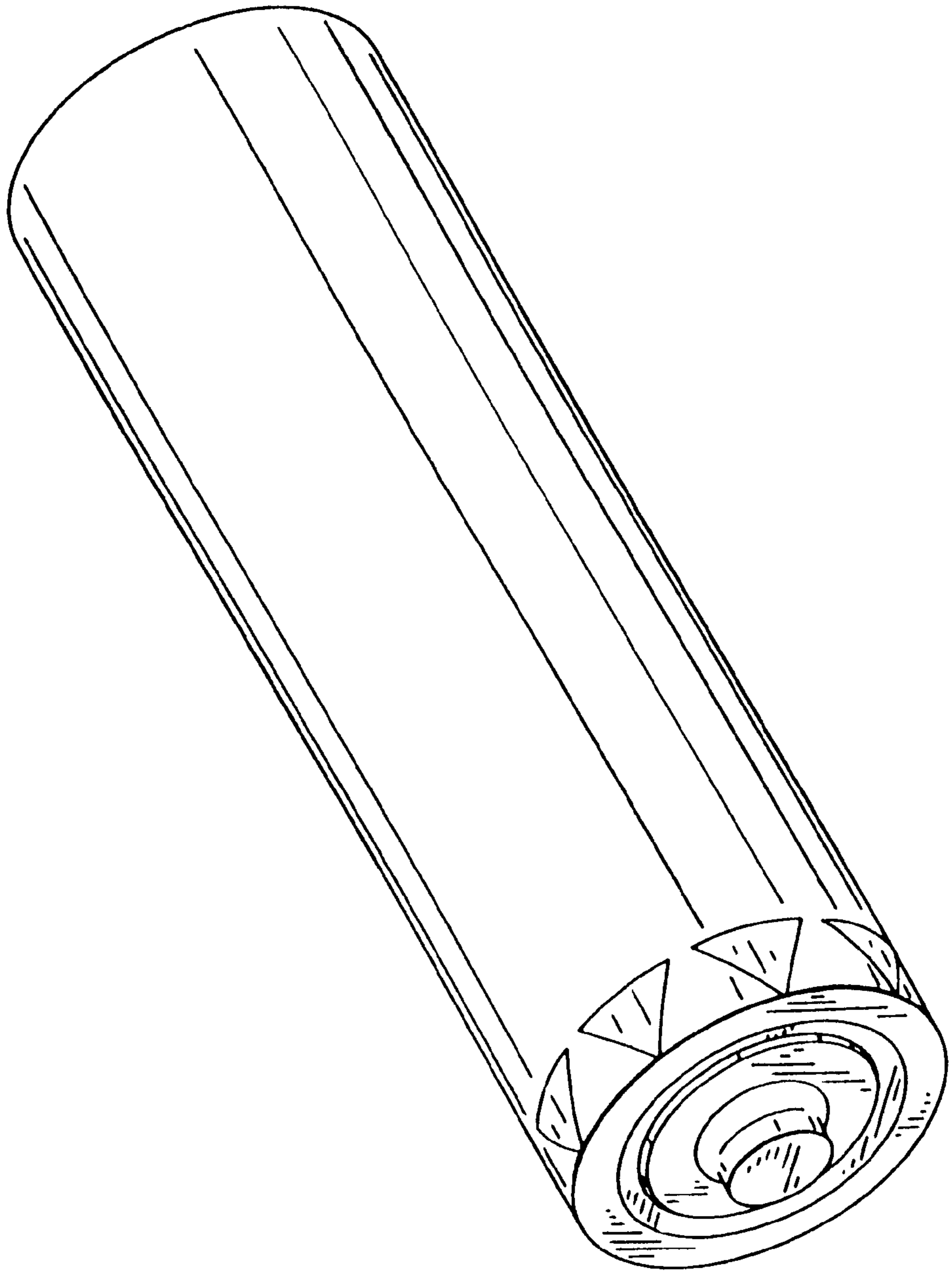

FIG. 2

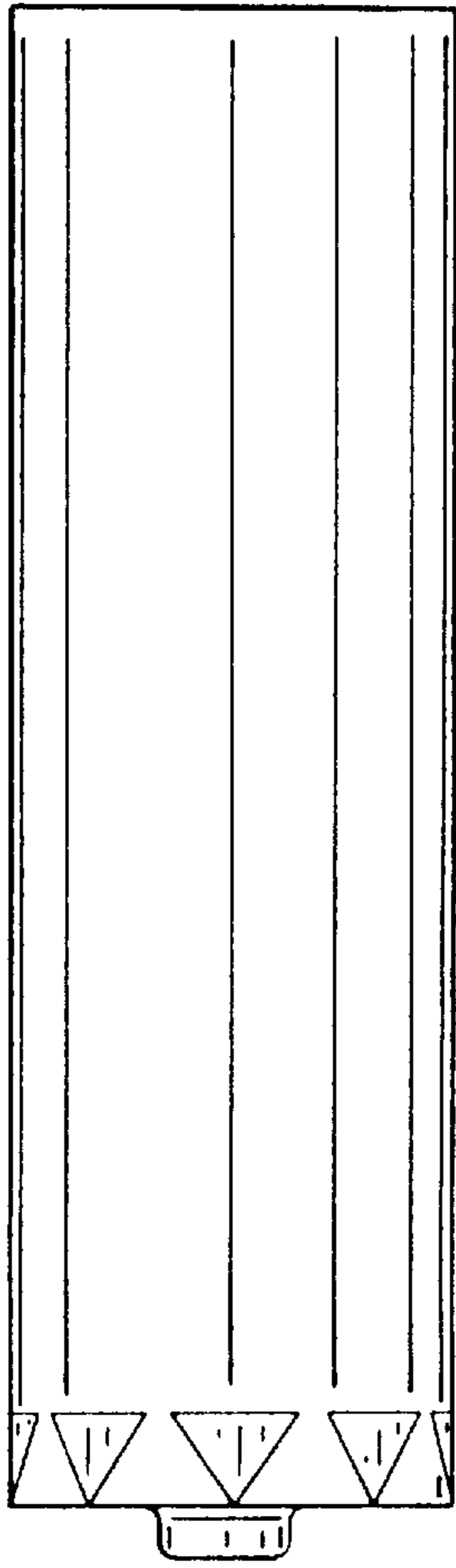

FIG. 6

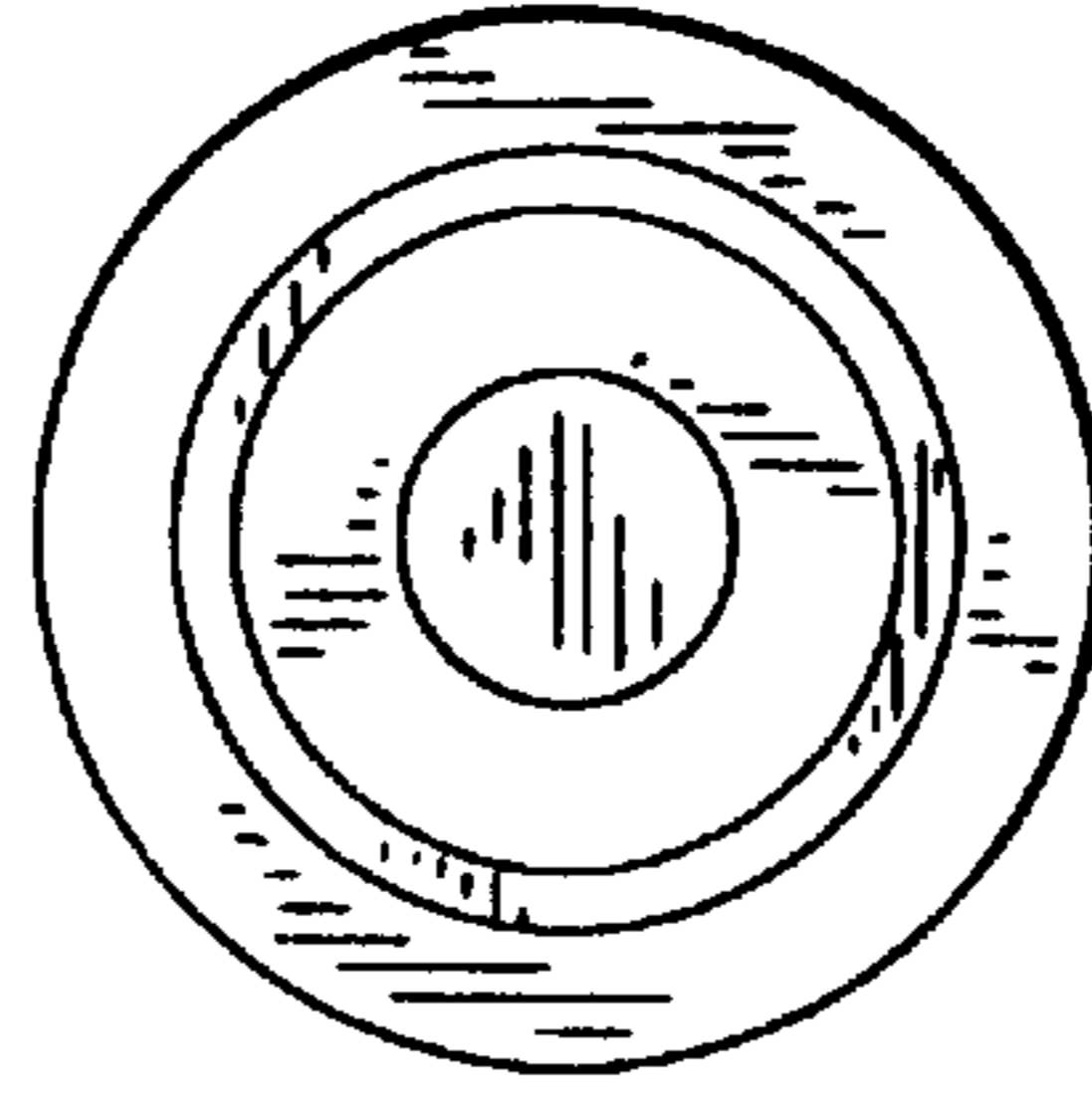

FIG. 4

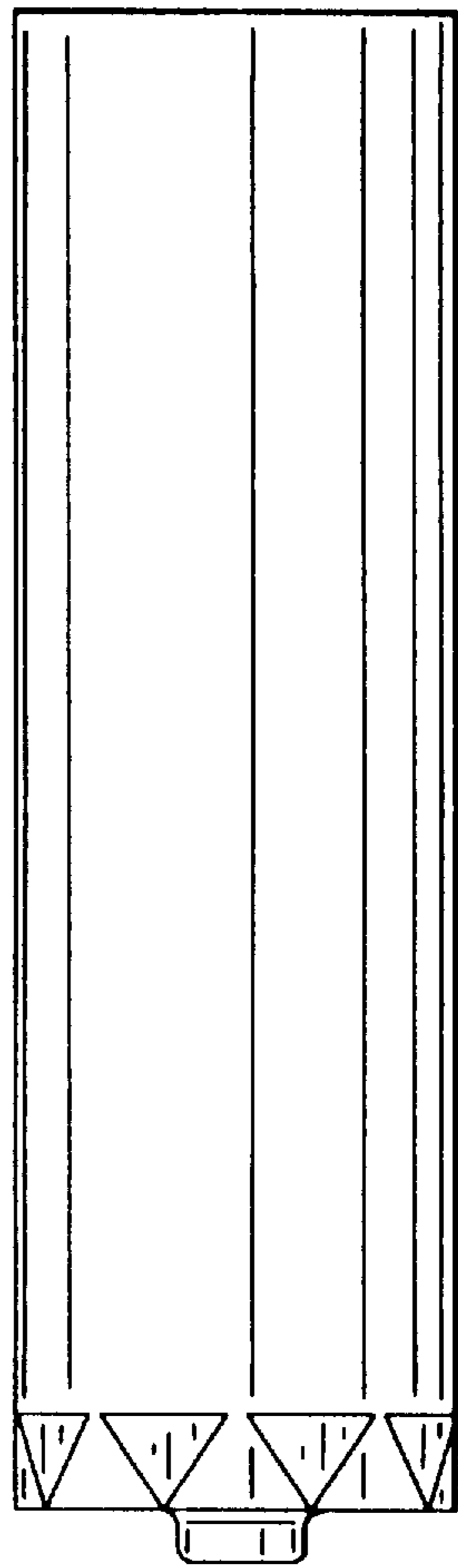

FIG. 3

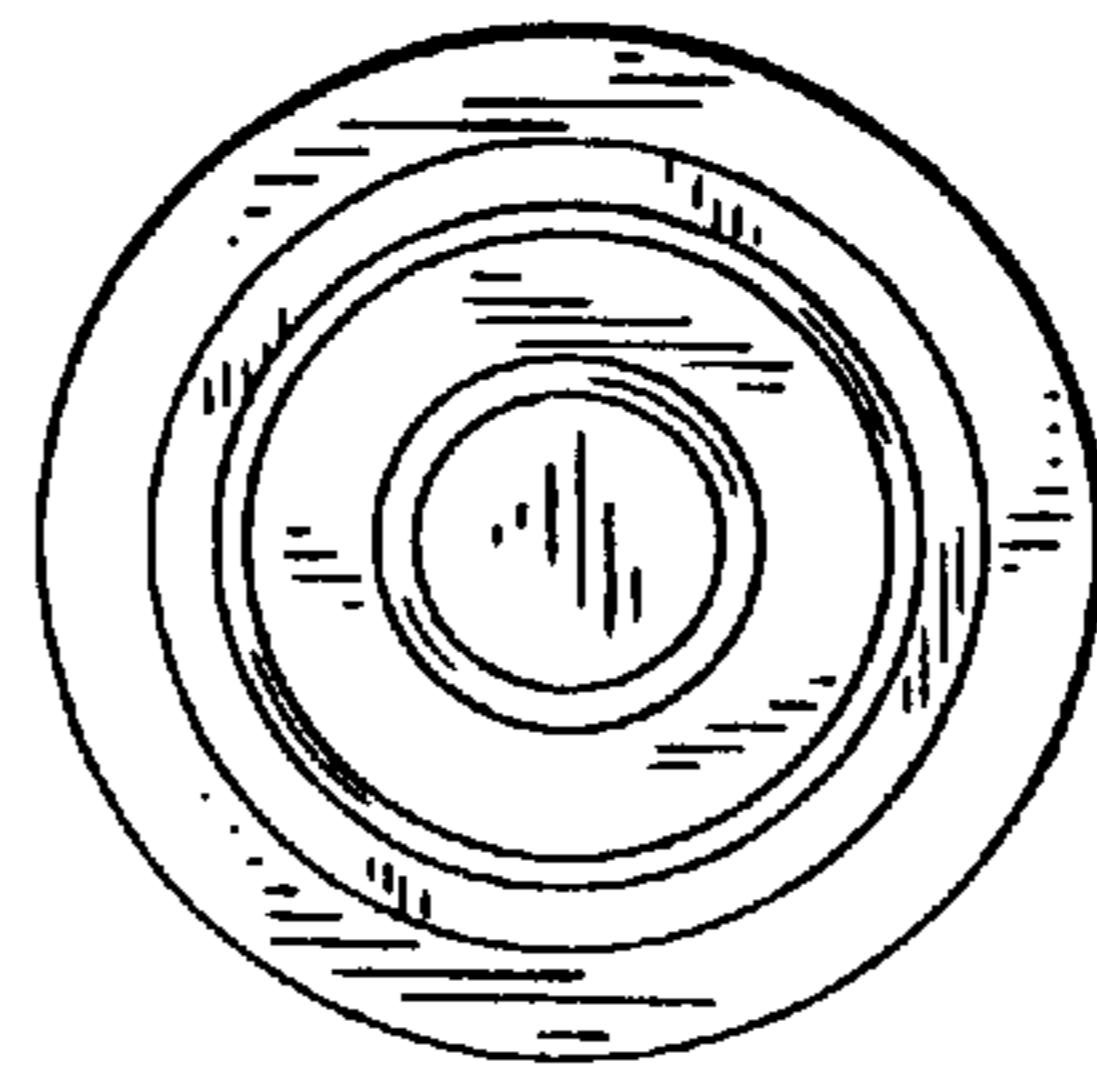

FIG. 5

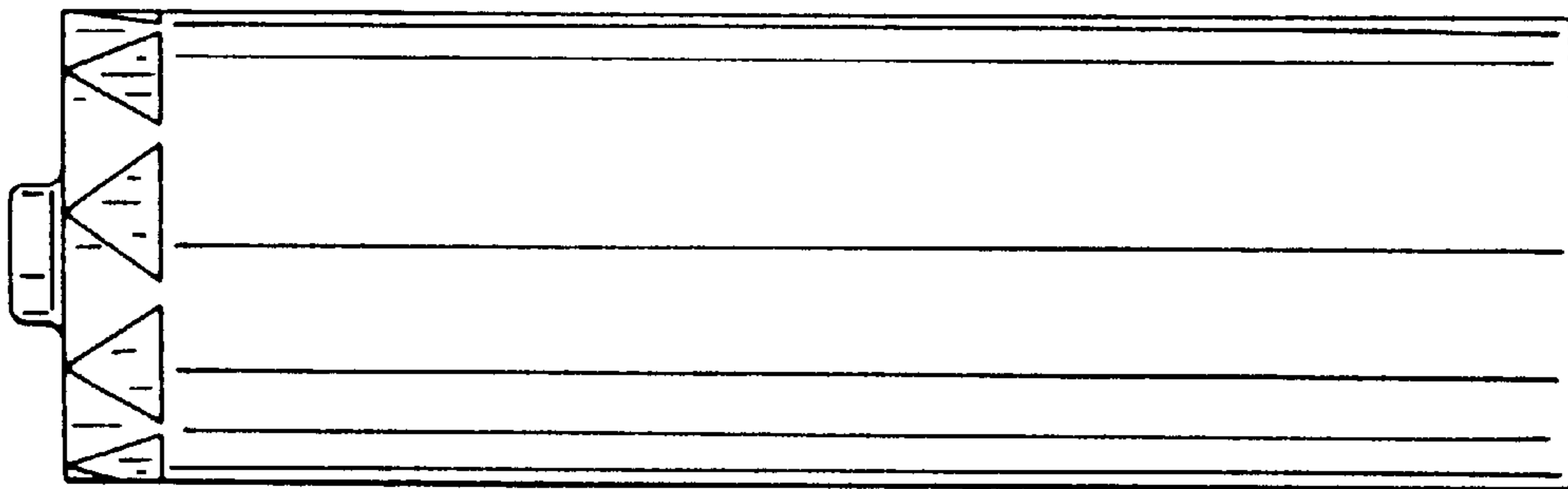

FIG. 7

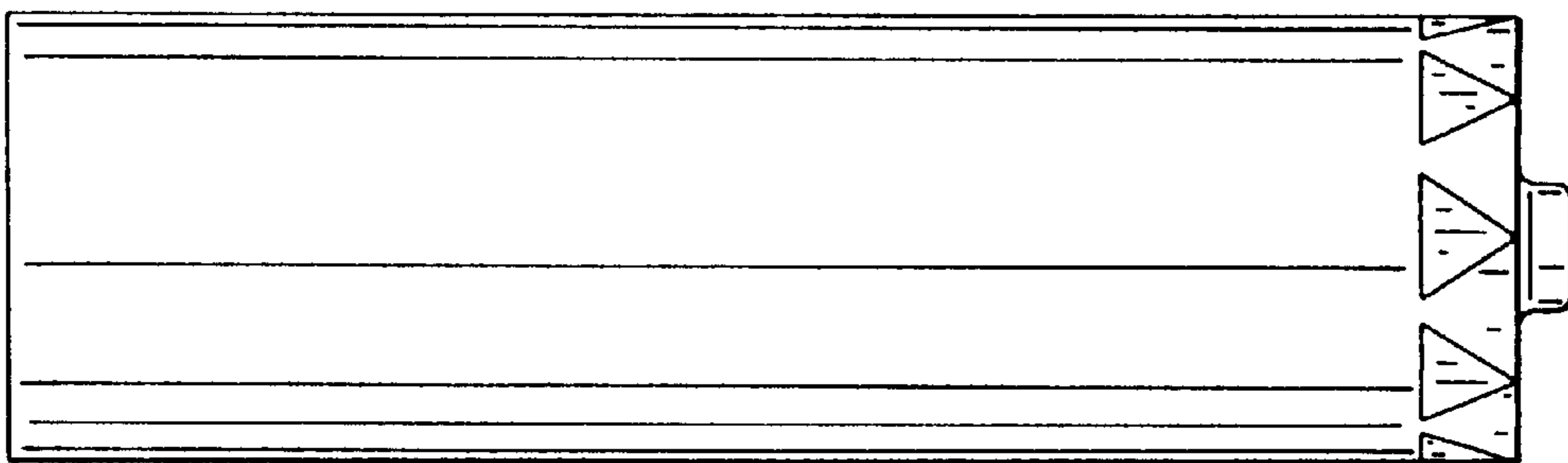

FIG. 8

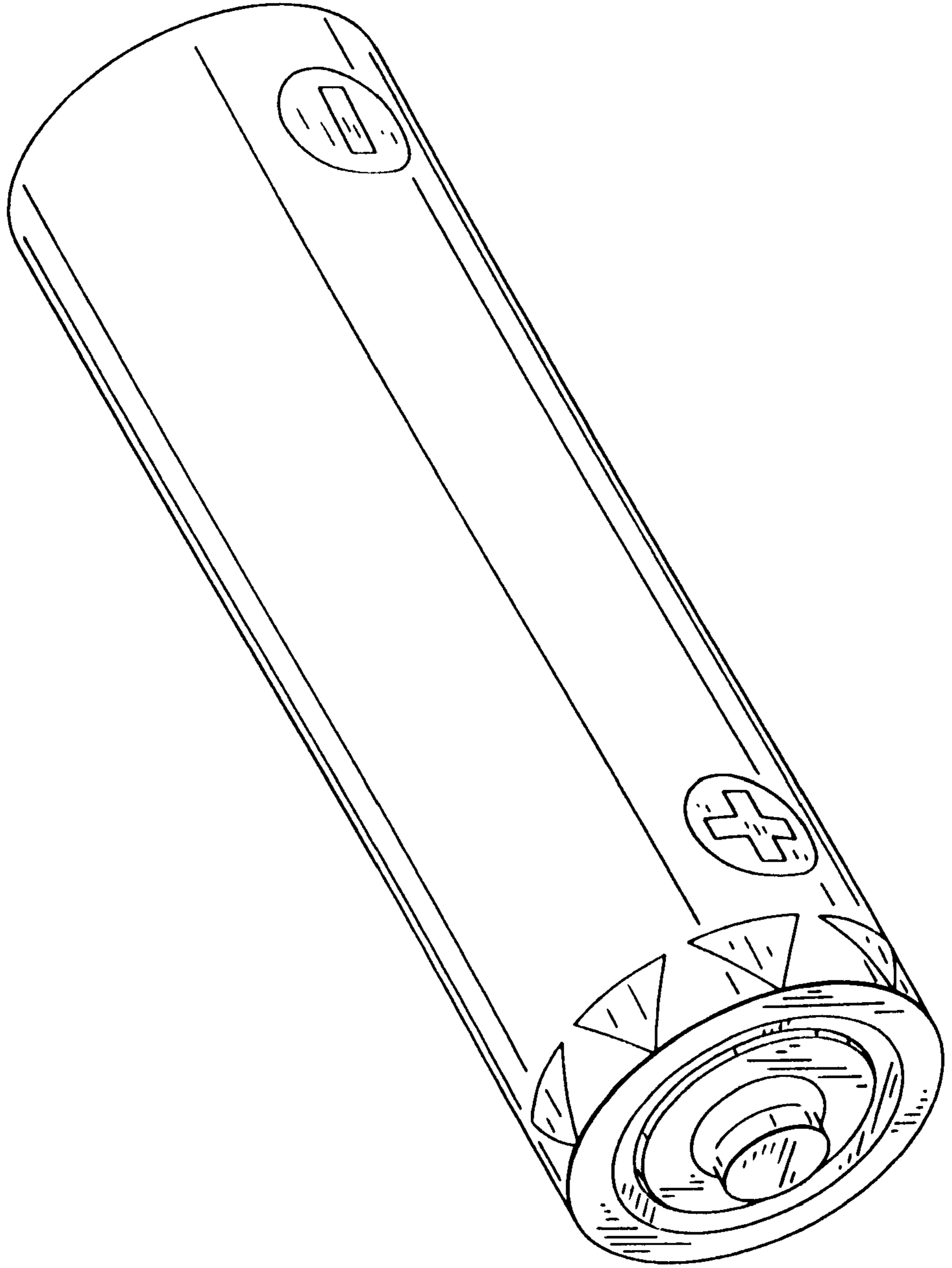

FIG. 9

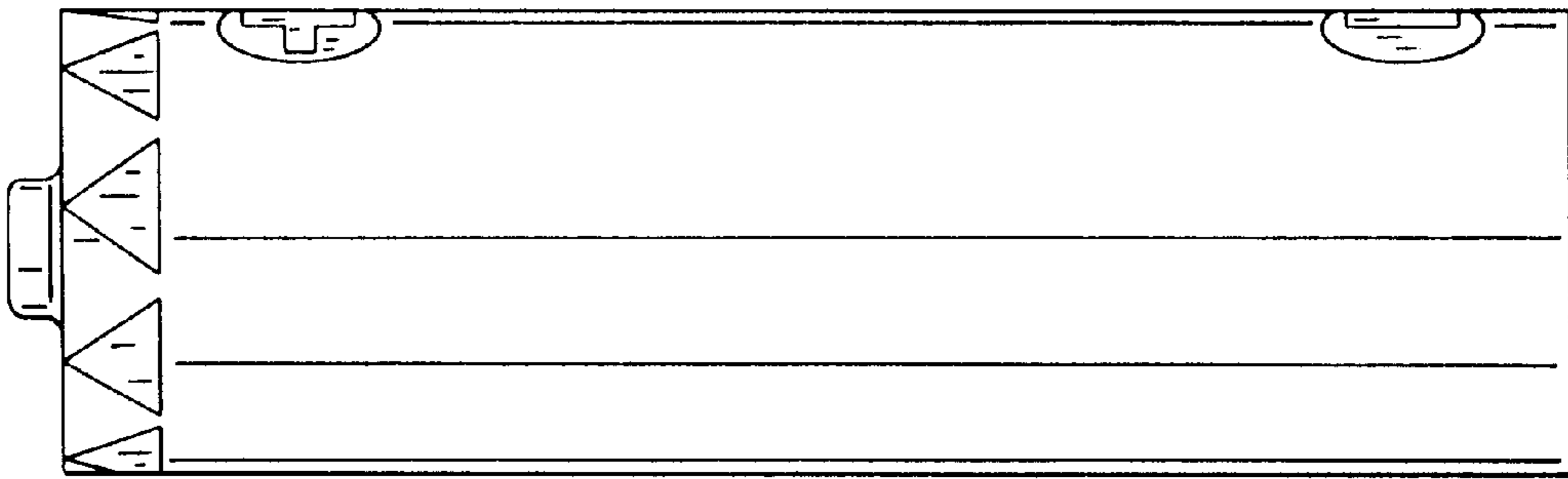

FIG. 14

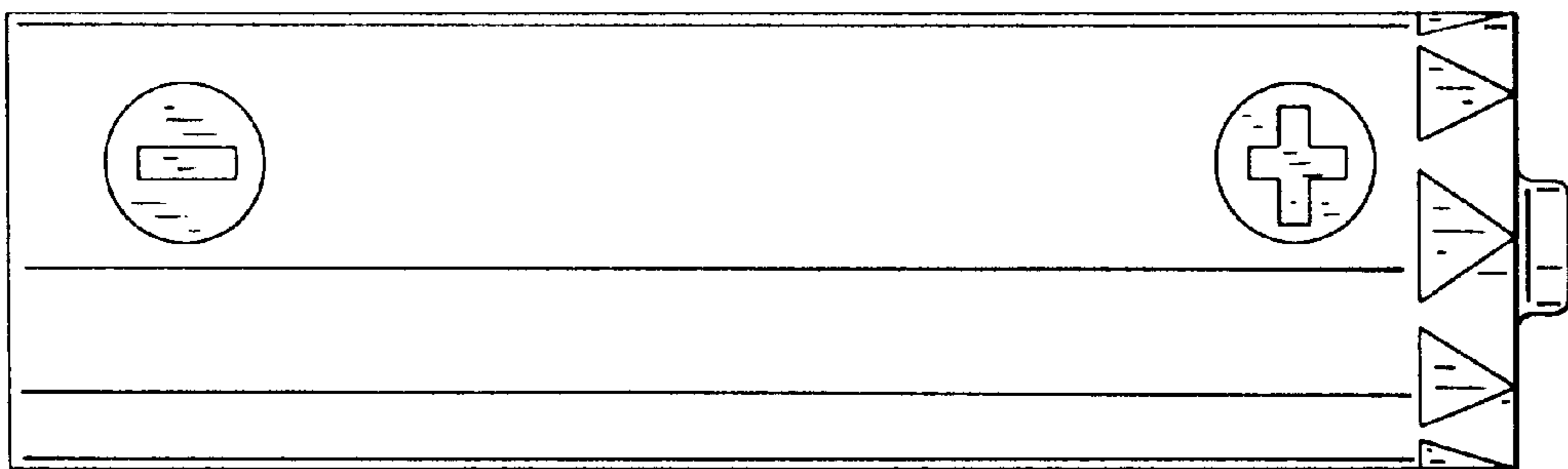

FIG. 13

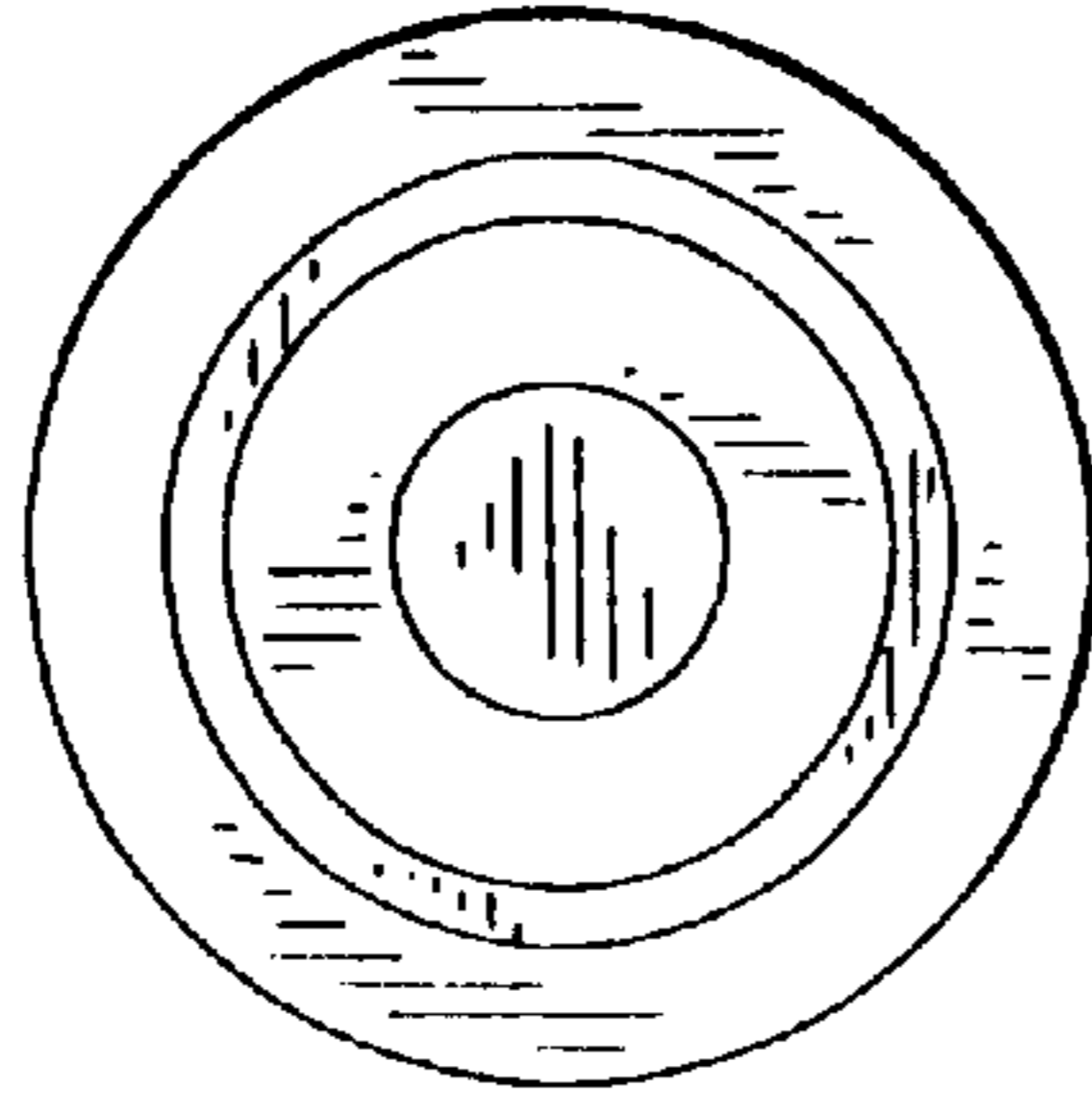

FIG. 11

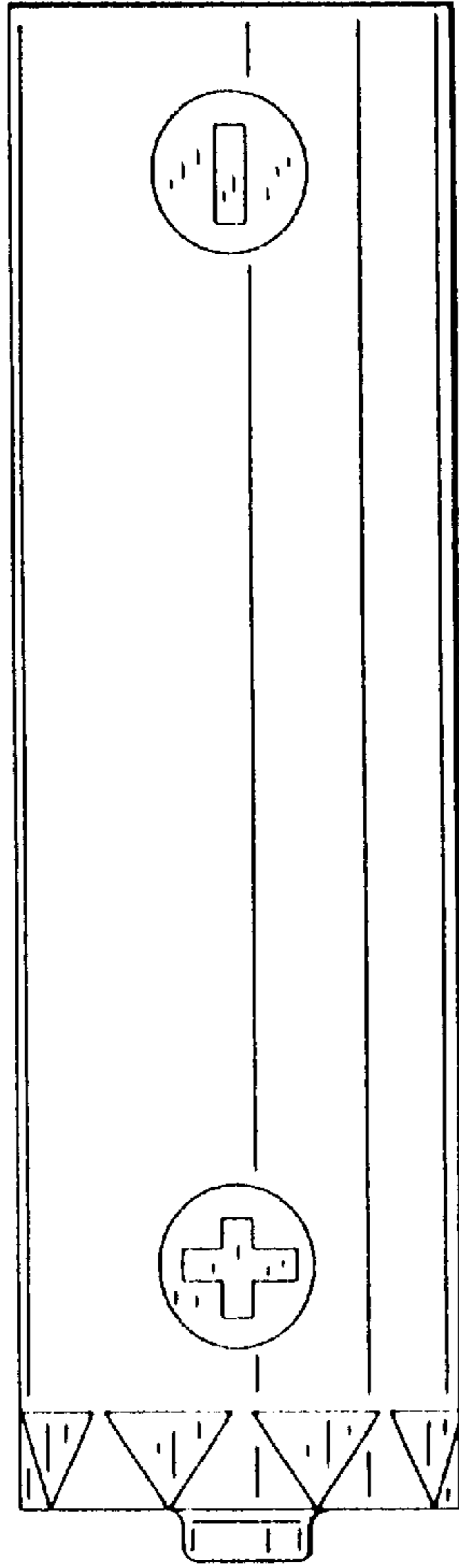

FIG. 10

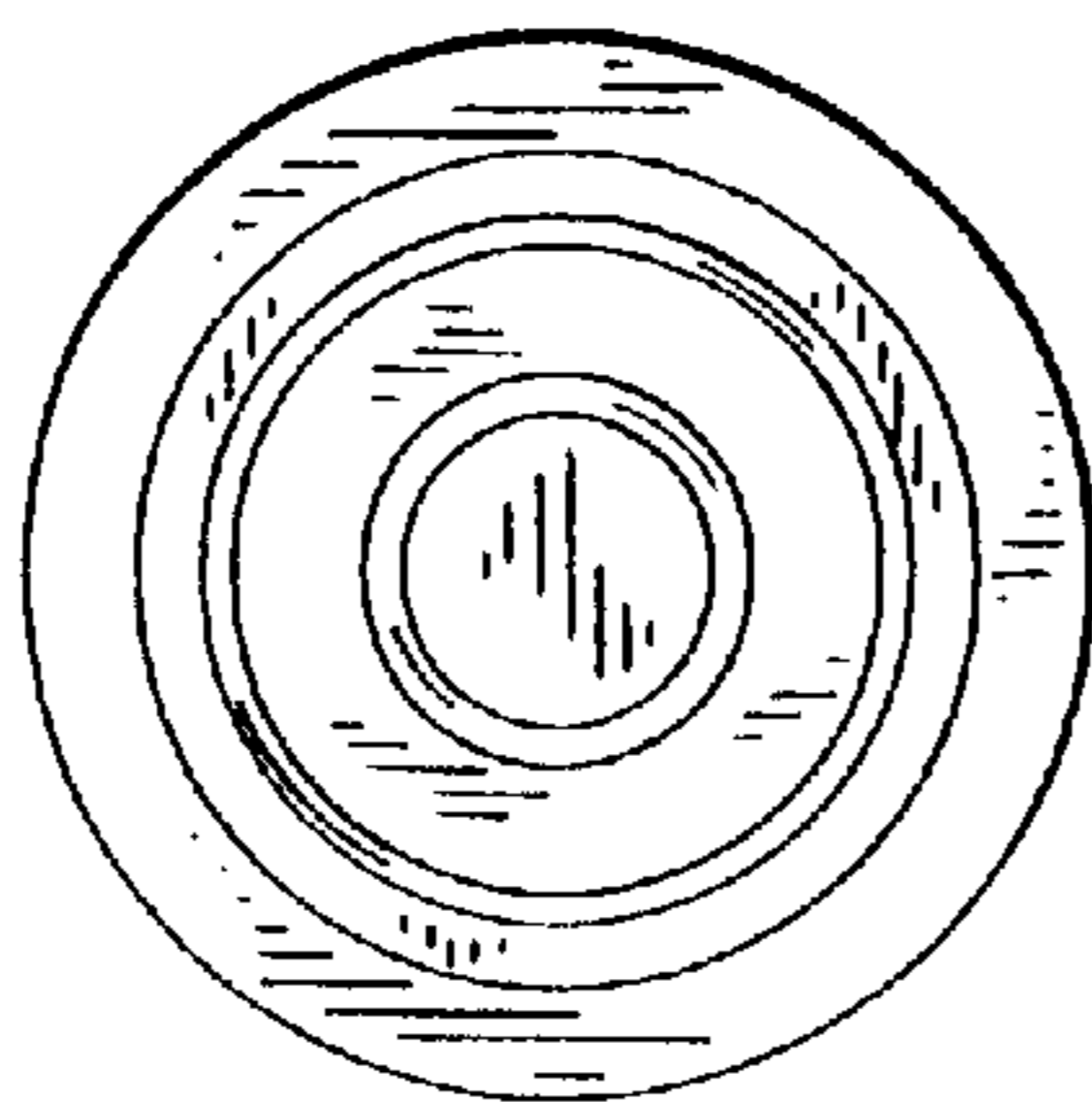

FIG. 12

