



US00D413498S

United States Patent [19] Krowchak

[11] **Patent Number: Des. 413,498**

[45] **Date of Patent: ** Sep. 7, 1999**

[54] **TAIL STOCK FOR A CARPET STRETCHER**

[76] Inventor: **Michael A. Krowchak**, 2751 Slater Ave. NW., East Canton, Ohio 44730

[**] Term: **14 Years**

[21] Appl. No.: **29/067,089**

[22] Filed: **Mar. 4, 1997**

[51] **LOC (6) Cl. 08-05**

[52] **U.S. Cl. D8/15; 254/200**

[58] **Field of Search D8/15; 7/103; 254/200, 205, 206, 211; 294/8.6; 227/12, 13**

[56] **References Cited**

U.S. PATENT DOCUMENTS

D. 344,222	2/1994	White	D8/15
3,300,182	1/1967	Bussard	254/212
3,706,440	12/1972	Ross	254/212
3,752,440	8/1973	Ream	254/209
3,784,078	1/1974	Escoe	227/13
4,538,846	9/1985	Alexander	254/209 X
4,828,305	5/1989	Gaddy	294/8.6
5,484,136	1/1996	Lopes et al.	254/200

Primary Examiner—Caron D. Veynar

Attorney, Agent, or Firm—Sand & Sebolt

[57] **CLAIM**

The ornamental design for a tail stock for a carpet stretcher, as shown and described.

DESCRIPTION

FIG. 1 is a rear perspective view of the tail stock for a carpet stretcher showing my new design;
 FIG. 2 is a front perspective view of the tail stock for a carpet stretcher of FIG. 1, the broken line showing of a hook attachment is for illustrative purposes only and forms no part of the claimed design;
 FIG. 3 is a top plan view of the tail stock for a carpet stretcher of FIG. 1;
 FIG. 4 is a rear elevational view of the tail stock for a carpet stretcher of FIG. 1;
 FIG. 5 is a right side elevational view of the tail stock for a carpet stretcher of FIG. 1;
 FIG. 6 is a left side elevational view of the tail stock for a carpet stretcher of FIG. 1;
 FIG. 7 is a front elevational view of the tail stock for a carpet stretcher of FIG. 1; and,
 FIG. 8 is a bottom plan view of the tail stock for a carpet stretcher of FIG. 1.

1 Claim, 3 Drawing Sheets

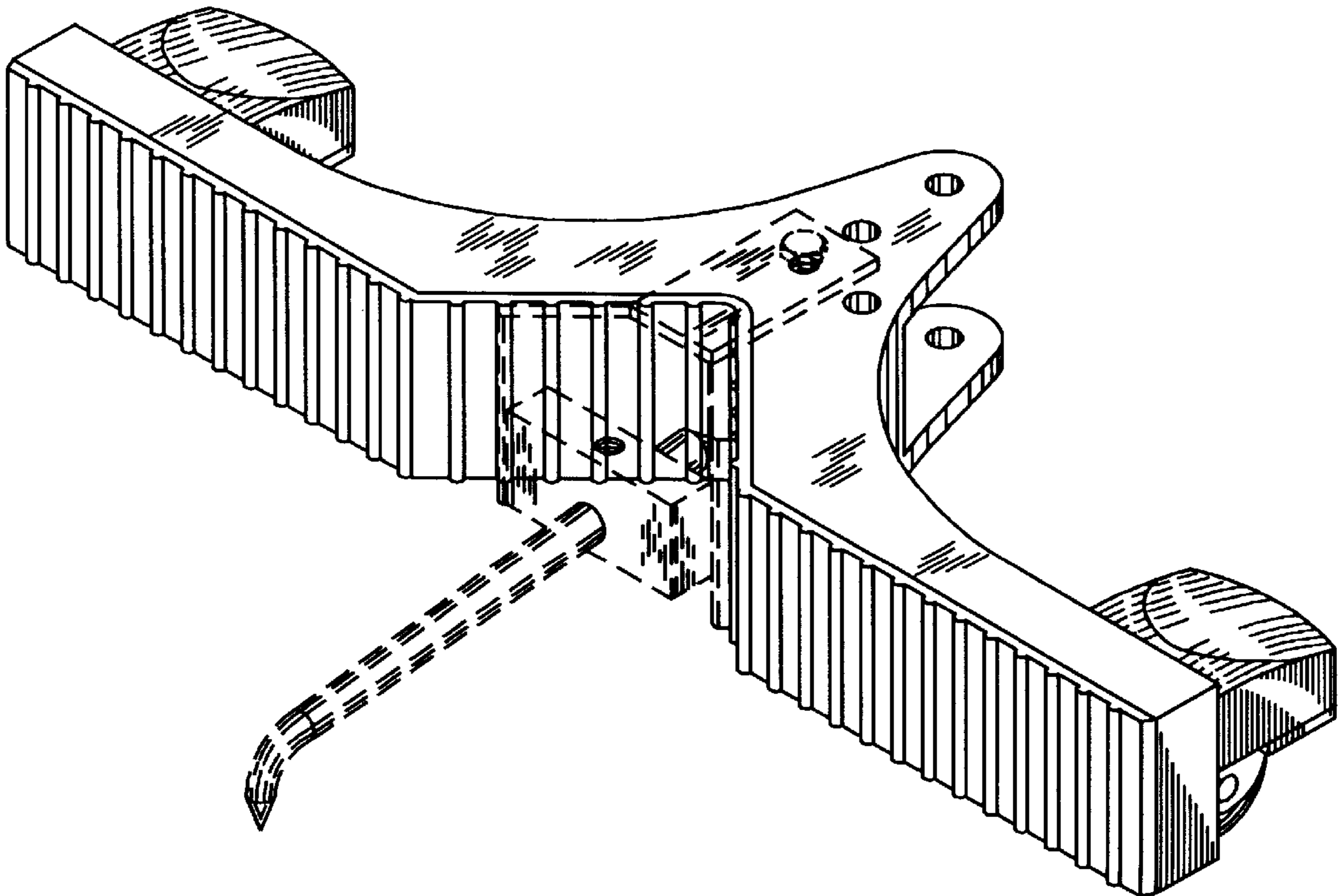

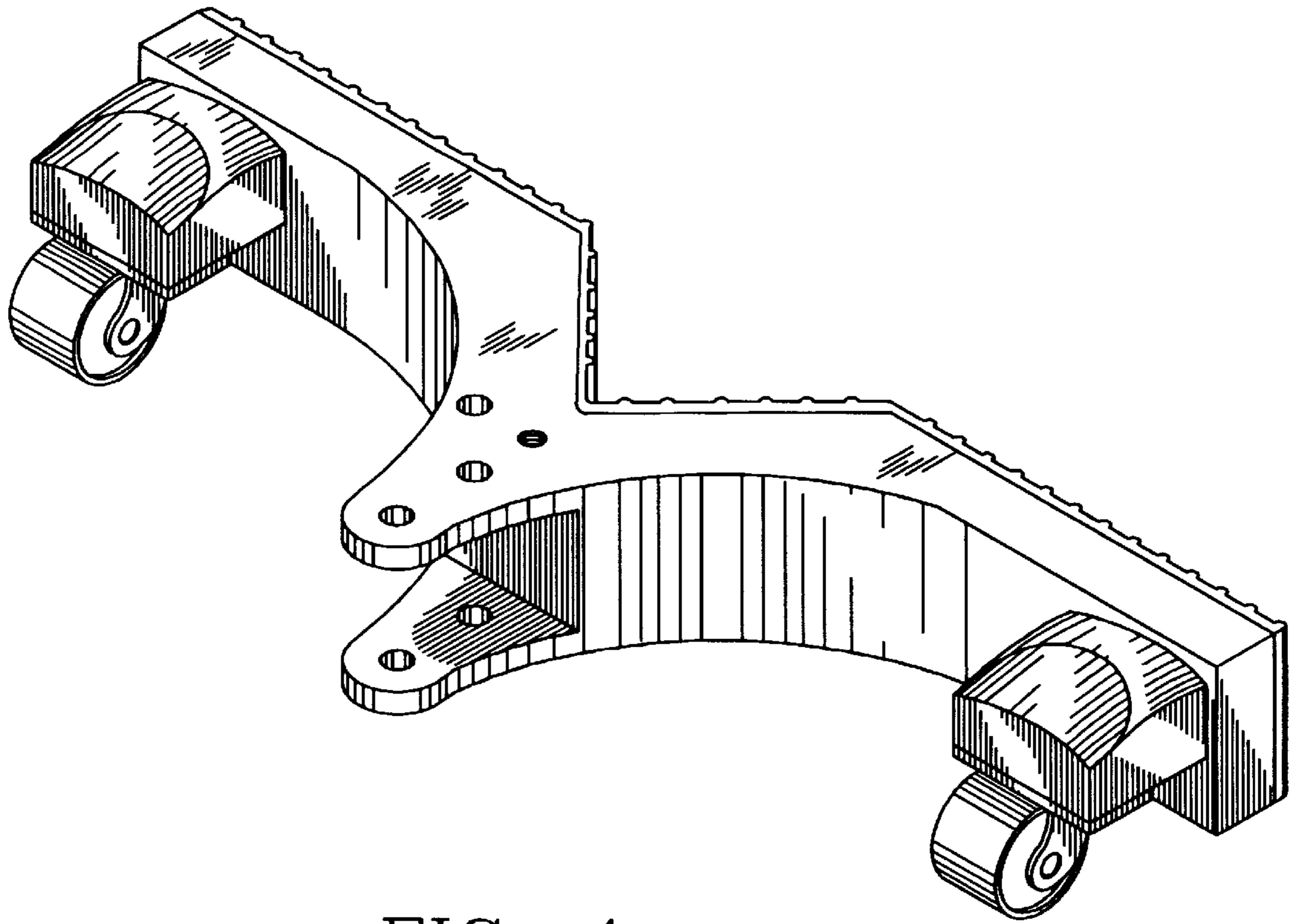

FIG. 1

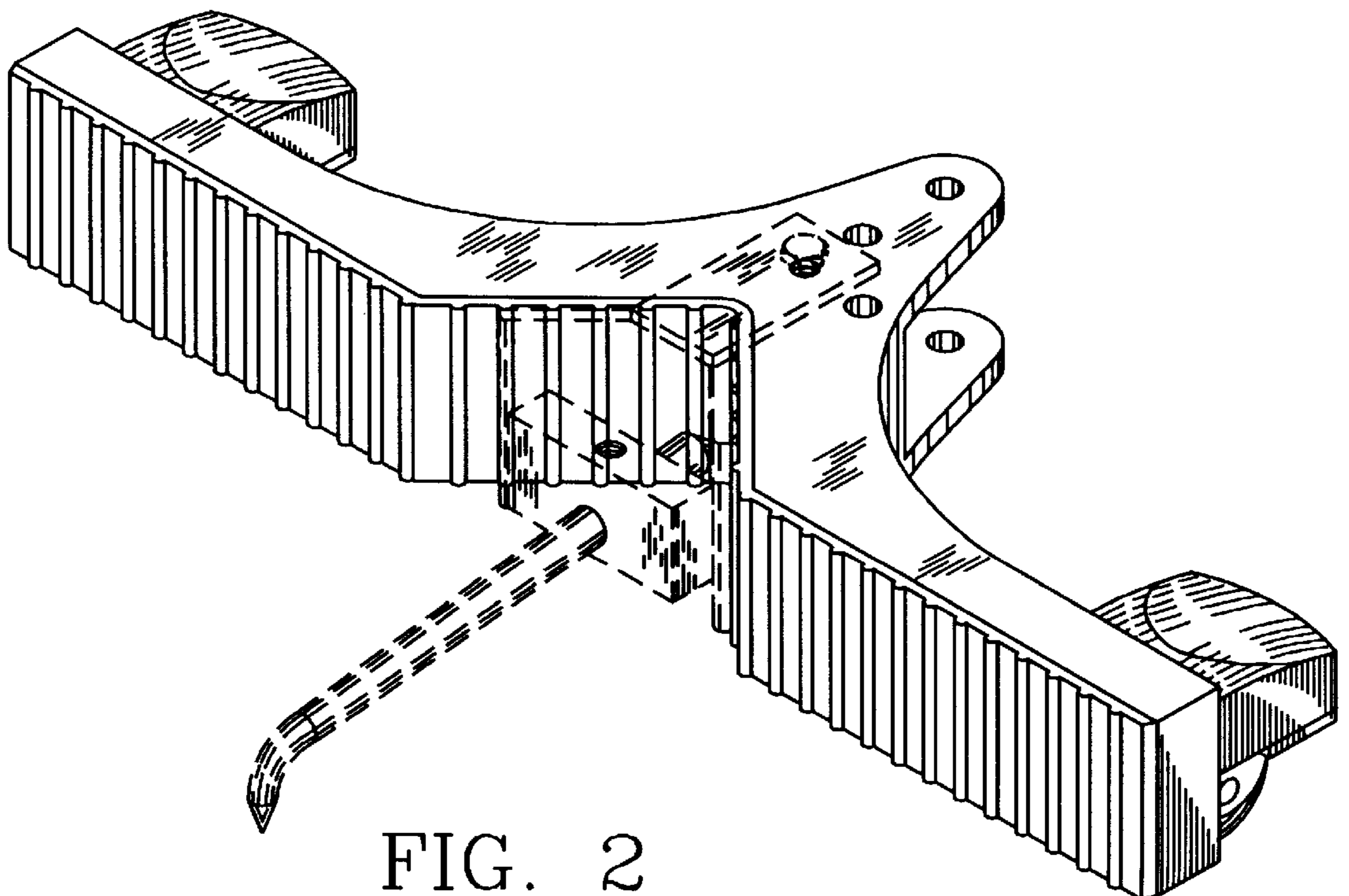

FIG. 2

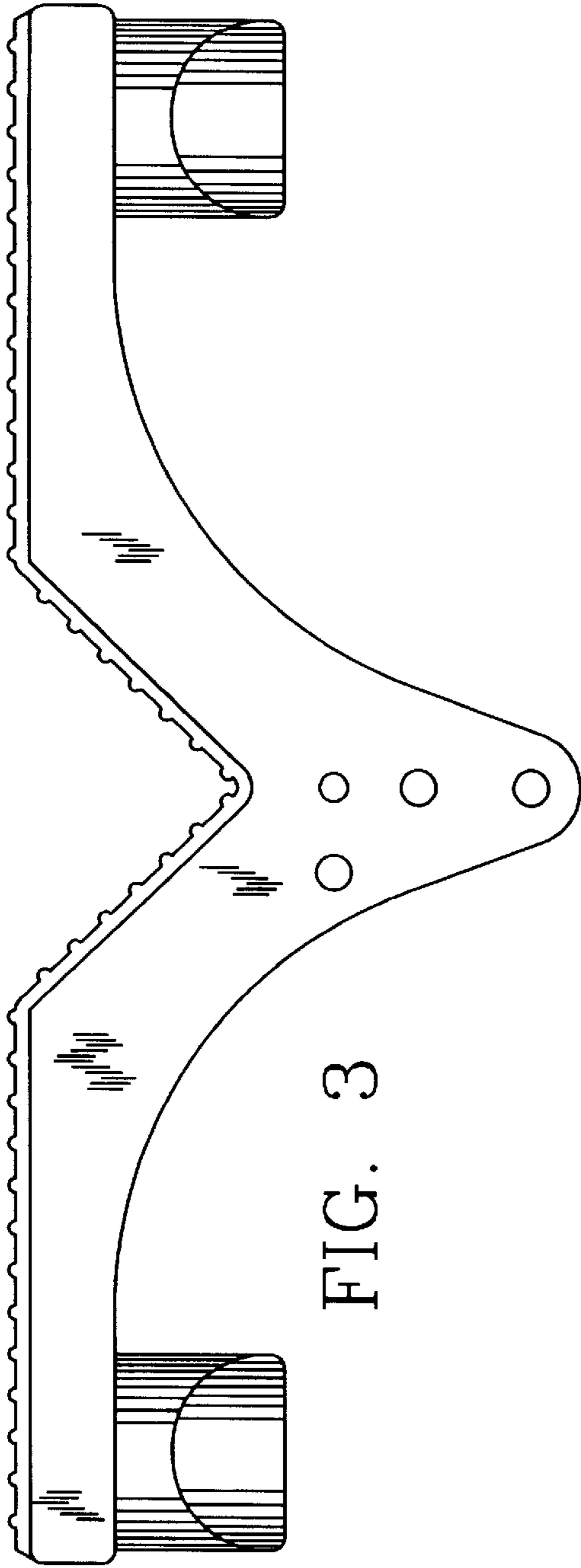

FIG. 3

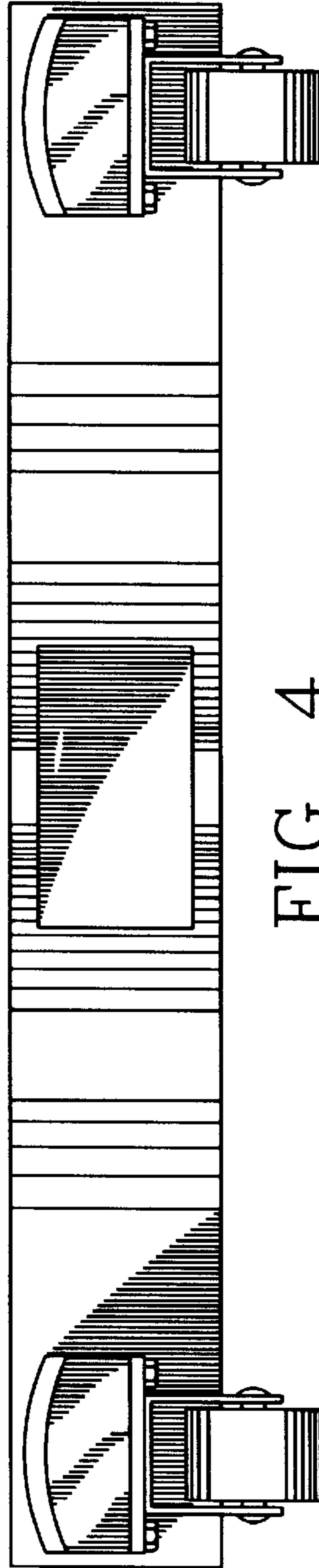

FIG. 4



FIG. 5

FIG. 6

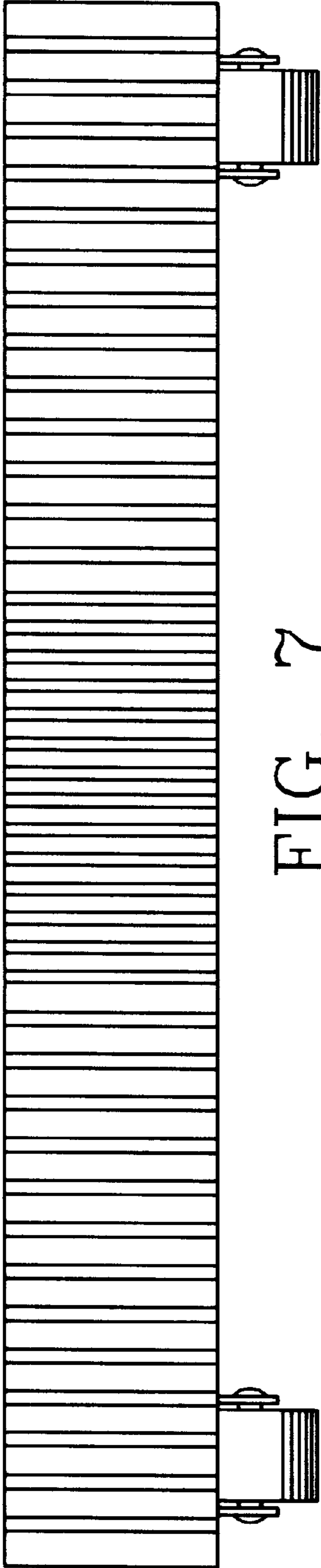

FIG. 7

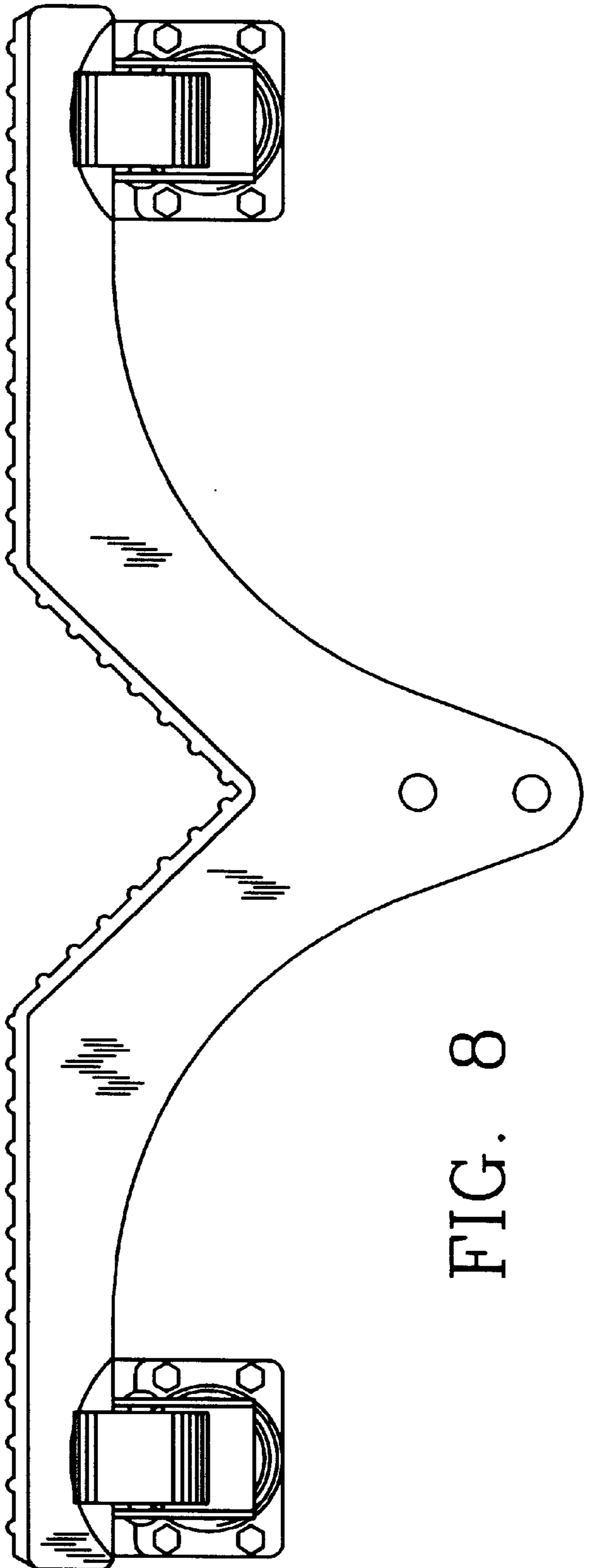

FIG. 8