



US00D413449S

# United States Patent [19] Hornyak

[11] Patent Number: **Des. 413,449**

[45] Date of Patent: **\*\* Sep. 7, 1999**

[54] **SITE FURNITURE**

D. 396,153 7/1998 Marks ..... D6/370  
D. 402,816 12/1998 Jeng ..... D6/370

[75] Inventor: **Marcella Kaye Hornyak**, Cabot, Pa.

[73] Assignee: **Keystone Ridge Designs, Inc.**, Butler, Pa.

*Primary Examiner*—Gary D. Watson  
*Attorney, Agent, or Firm*—Webb Ziesenheim Logsdon Orkin & Hanson, P.C.

[\*\*] Term: **14 Years**

[57] **CLAIM**

[21] Appl. No.: **29/088,305**

The ornamental design for site furniture, as shown and described.

[22] Filed: **May 20, 1998**

**DESCRIPTION**

[51] **LOC (6) Cl.** ..... **06-01**

[52] **U.S. Cl.** ..... **D6/370; D6/376; D6/381**

[58] **Field of Search** ..... D6/334, 335, 370,  
D6/374, 376, 379, 380, 381, 500, 501,  
502; 297/232, 452-63

FIG. 1 is a perspective view of site furniture in the form of a bench showing my new design;  
FIG. 2 is a front elevation view thereof;  
FIG. 3 is a rear elevation view thereof;  
FIG. 4 is a top plan view thereof;  
FIG. 5 is a bottom plan view thereof;  
FIG. 6 is a right side elevation view thereof; and,  
FIG. 7 is a left side elevation view thereof.

[56] **References Cited**

**U.S. PATENT DOCUMENTS**

D. 340,591 10/1993 Lamalle ..... D6/370  
D. 366,160 1/1996 Walters, III et al. .... D6/370  
D. 368,173 3/1996 Kramer ..... D6/370  
D. 372,133 7/1996 Slear ..... D6/370  
D. 376,270 12/1996 Slear ..... D6/370

The broken lines shown in FIGS. 1, 2, 3, 5, 6 and 7 are for illustrative purposes only and form no part of the claimed design.

**1 Claim, 3 Drawing Sheets**

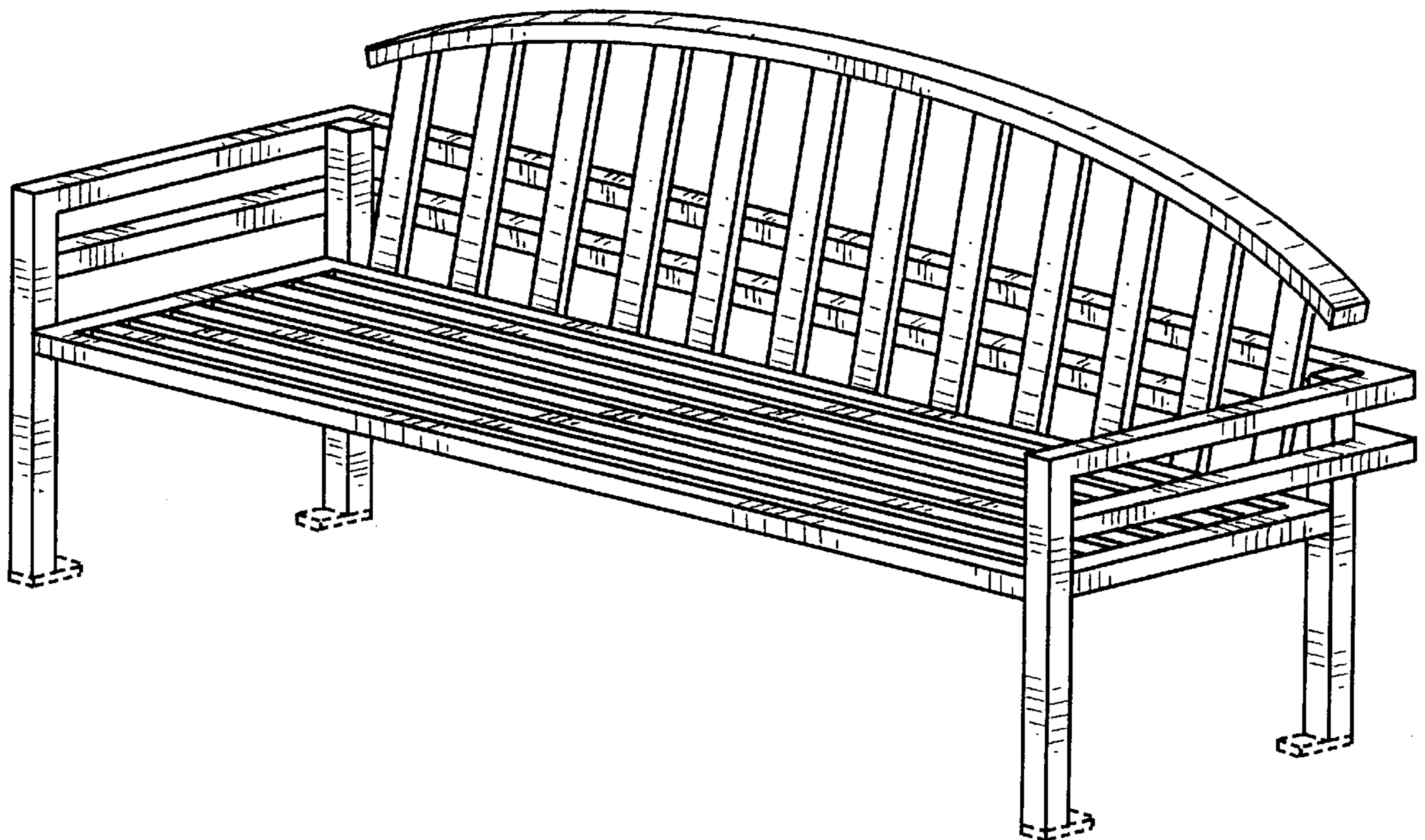

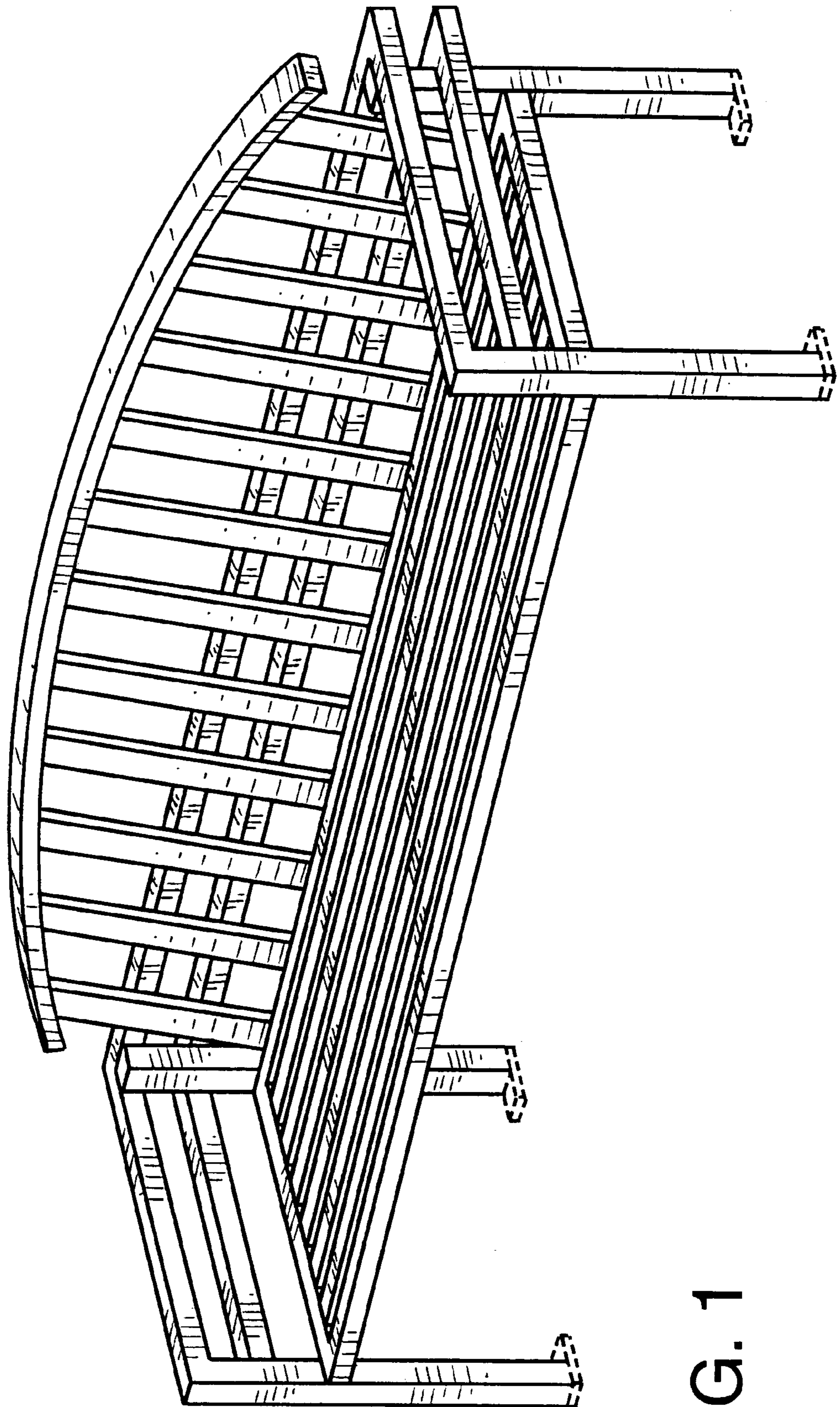

FIG. 1

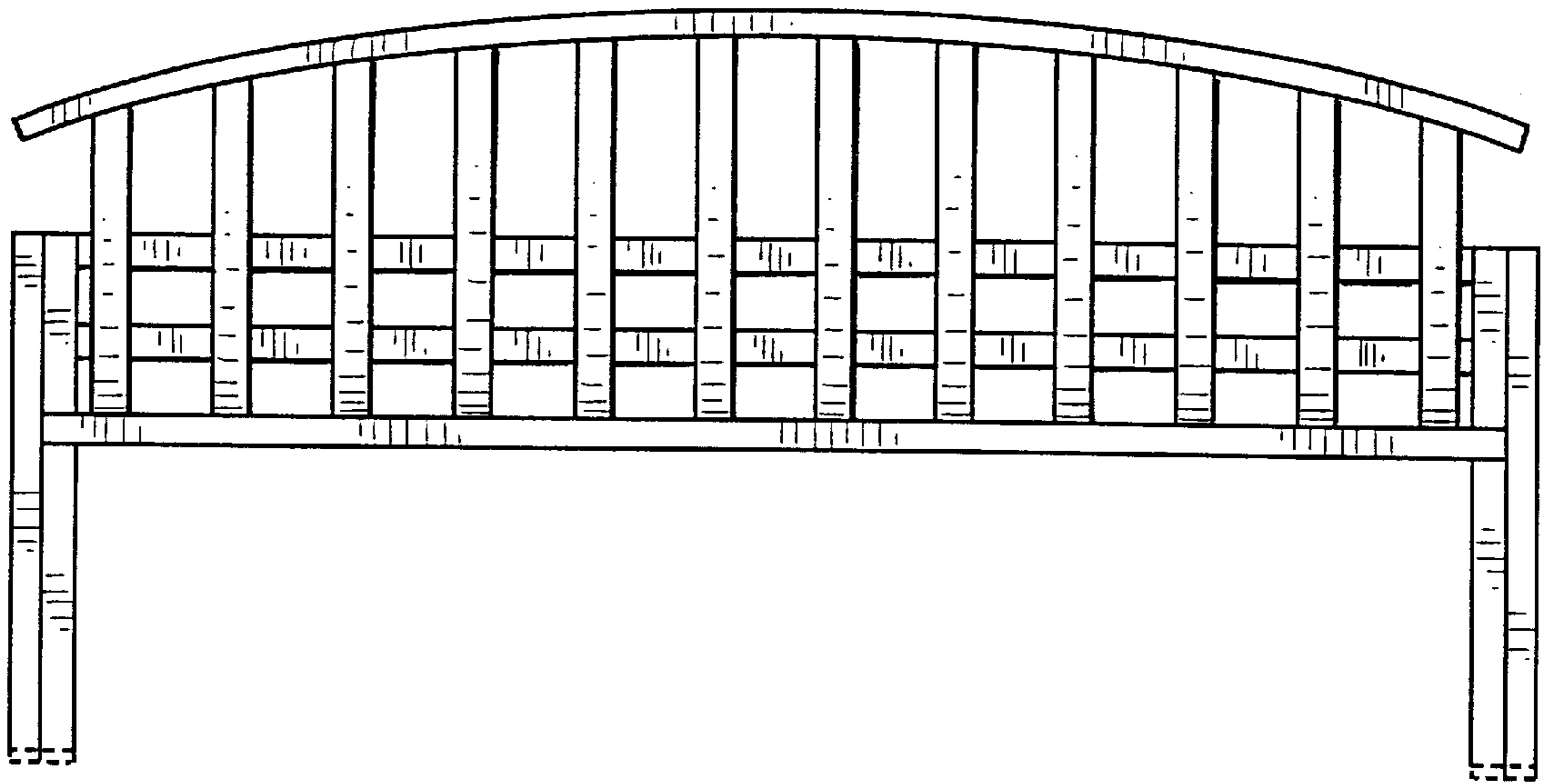

FIG. 2

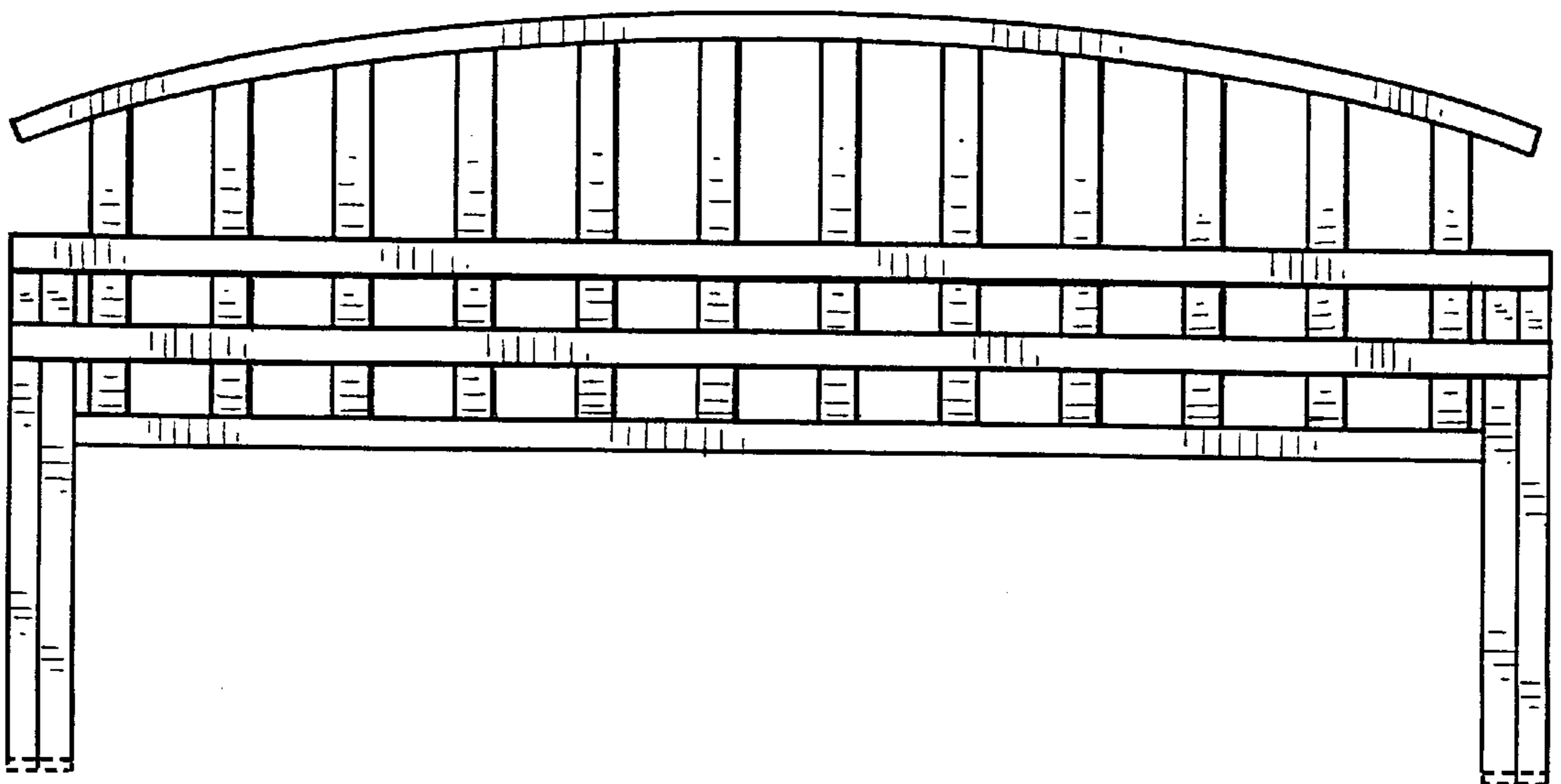

FIG. 3

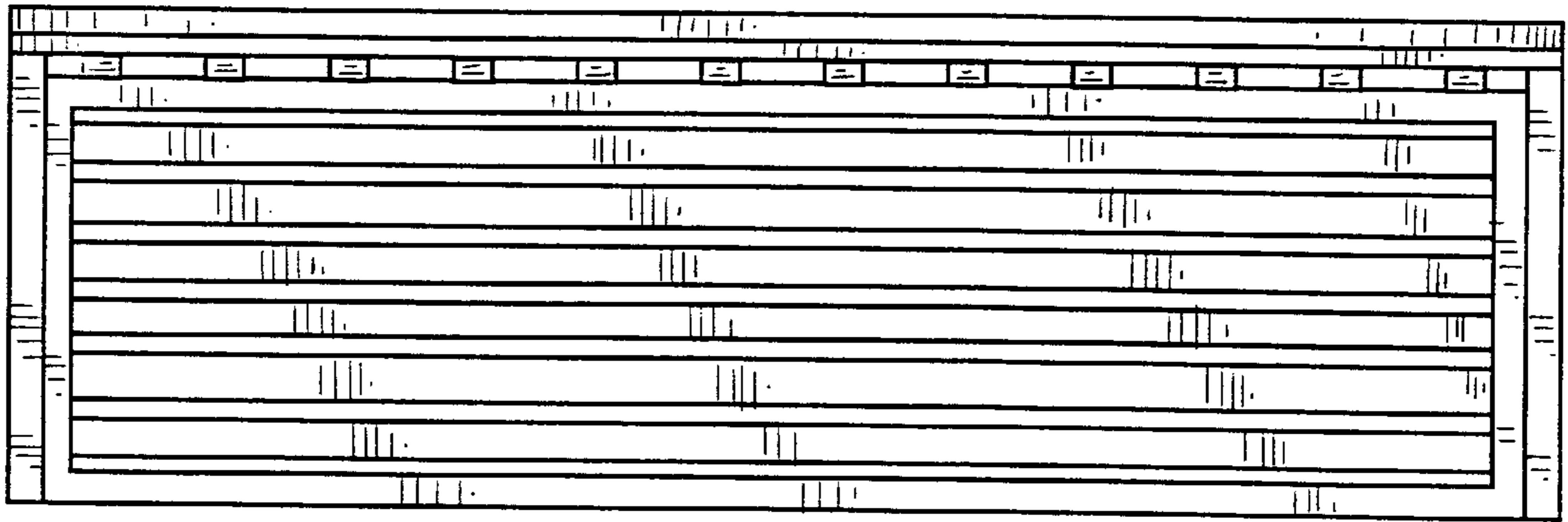

FIG. 4

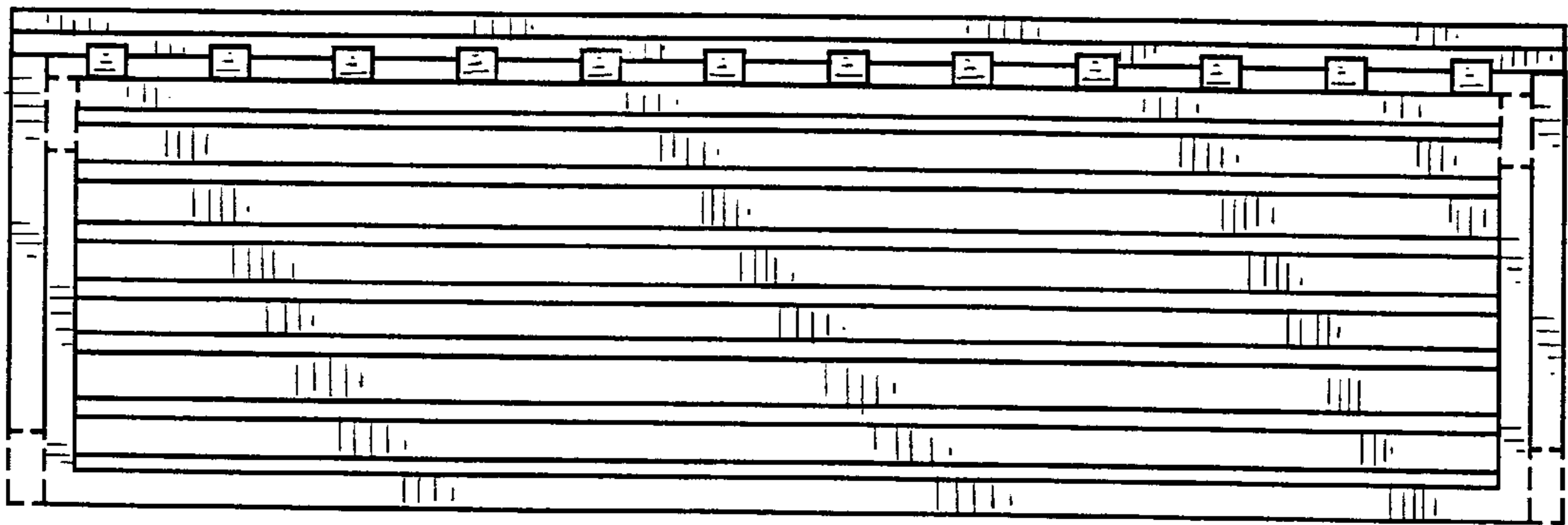

FIG. 5

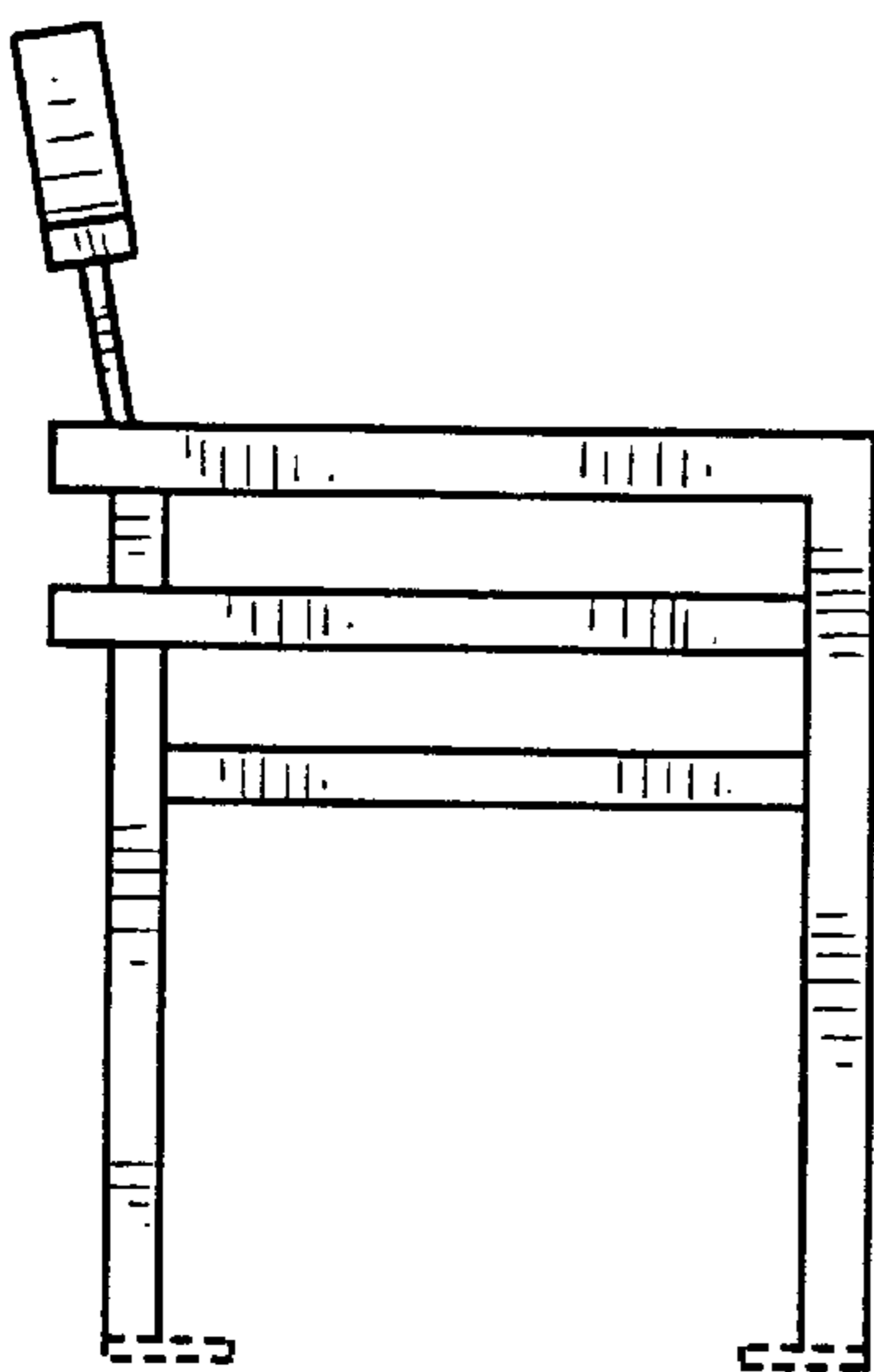

FIG. 6

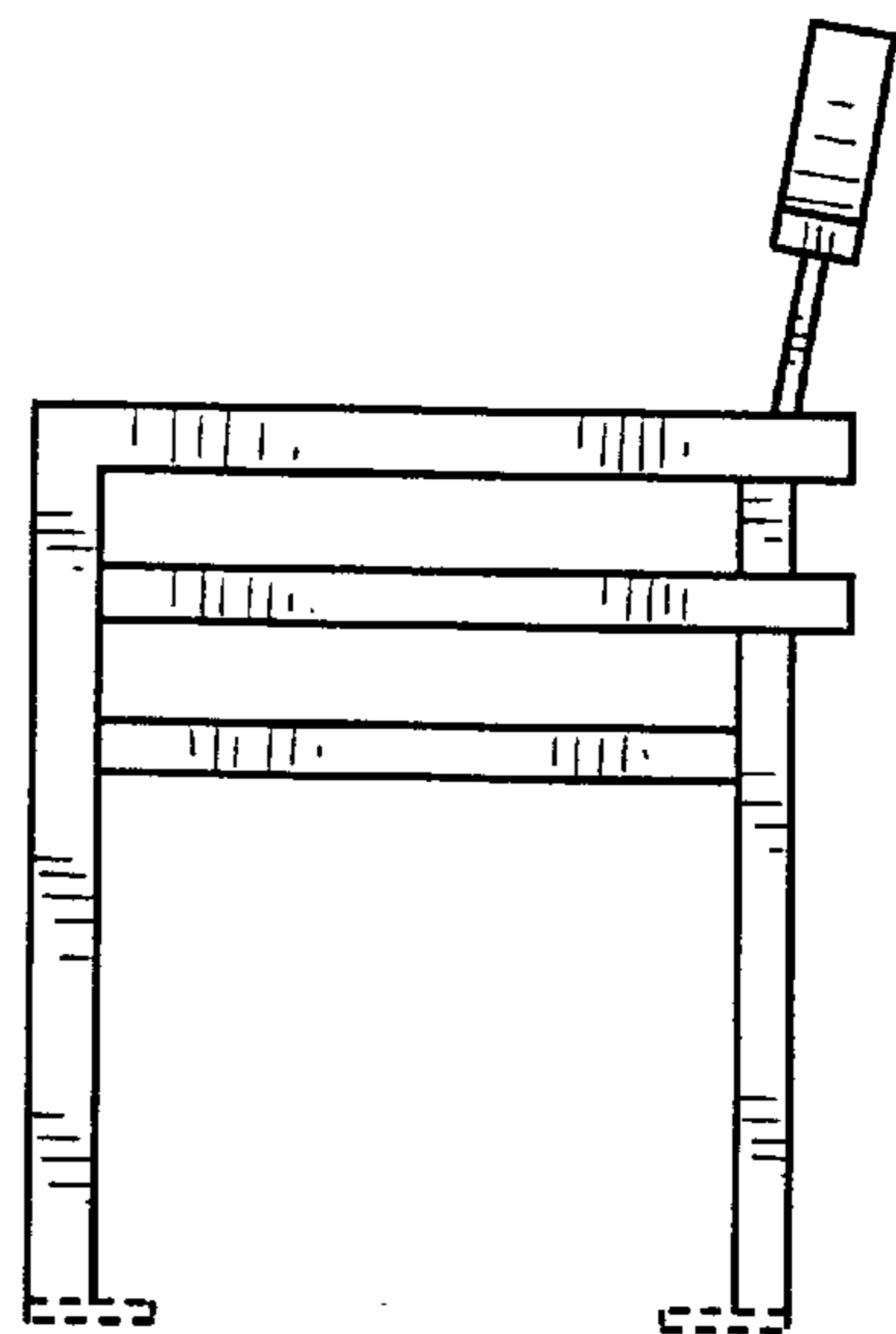

FIG. 7