



US00D413369S

# United States Patent [19] Peng

[11] Patent Number: Des. 413,369

[45] Date of Patent: \*\* Aug. 31, 1999

[54] IRON HEAD

D. 401,637 11/1998 Best et al. .... D21/747

[76] Inventor: **Wan-Hsiung Peng**, No. 2-1, Alley 2,  
Lane 242, Chung Shan Road, Section 2,  
Chung Ho City, Taipei Hsien, Taiwan

*Primary Examiner*—Mitchell I Siegel  
*Attorney, Agent, or Firm*—Dougherty & Troxell

[\*\*] Term: **14 Years**

### [57] CLAIM

The ornamental design for an iron head, as shown and described.

[21] Appl. No.: **29/093,231**

### DESCRIPTION

[22] Filed: **Sep. 4, 1998**

[51] LOC (6) Cl. .... **21-02**

[52] U.S. Cl. .... **D21/748**

[58] Field of Search ..... D21/747-751;  
473/324, 327, 328, 350, 330, 331

FIG. 1 is a perspective view of an iron head showing my new design;

FIG. 2 is a front elevation view thereof;

FIG. 3 is a rear elevation view thereof;

FIG. 4 is a side elevation view thereof;

FIG. 5 is an elevation view of the side opposite to the FIG. 4;

FIG. 6 is a top plan view thereof;

FIG. 7 is a bottom plan view thereof;

FIG. 8 is rear perspective view thereof; and,

FIG. 9 is a cross sectional perspective view taken along the line 9-9 of FIG. 2.

### [56] References Cited

#### U.S. PATENT DOCUMENTS

D. 83,700	3/1931	Schmermund	.....	D21/751
D. 256,264	8/1980	Solheim	.....	D21/748
D. 353,644	12/1994	Hirsch et al.	.....	D21/748
D. 362,288	9/1995	McGraw et al.	.....	D21/749
D. 364,434	11/1995	McGraw et al.	.....	D21/749
D. 365,616	12/1995	Lee	.....	D21/748

**1 Claim, 4 Drawing Sheets**

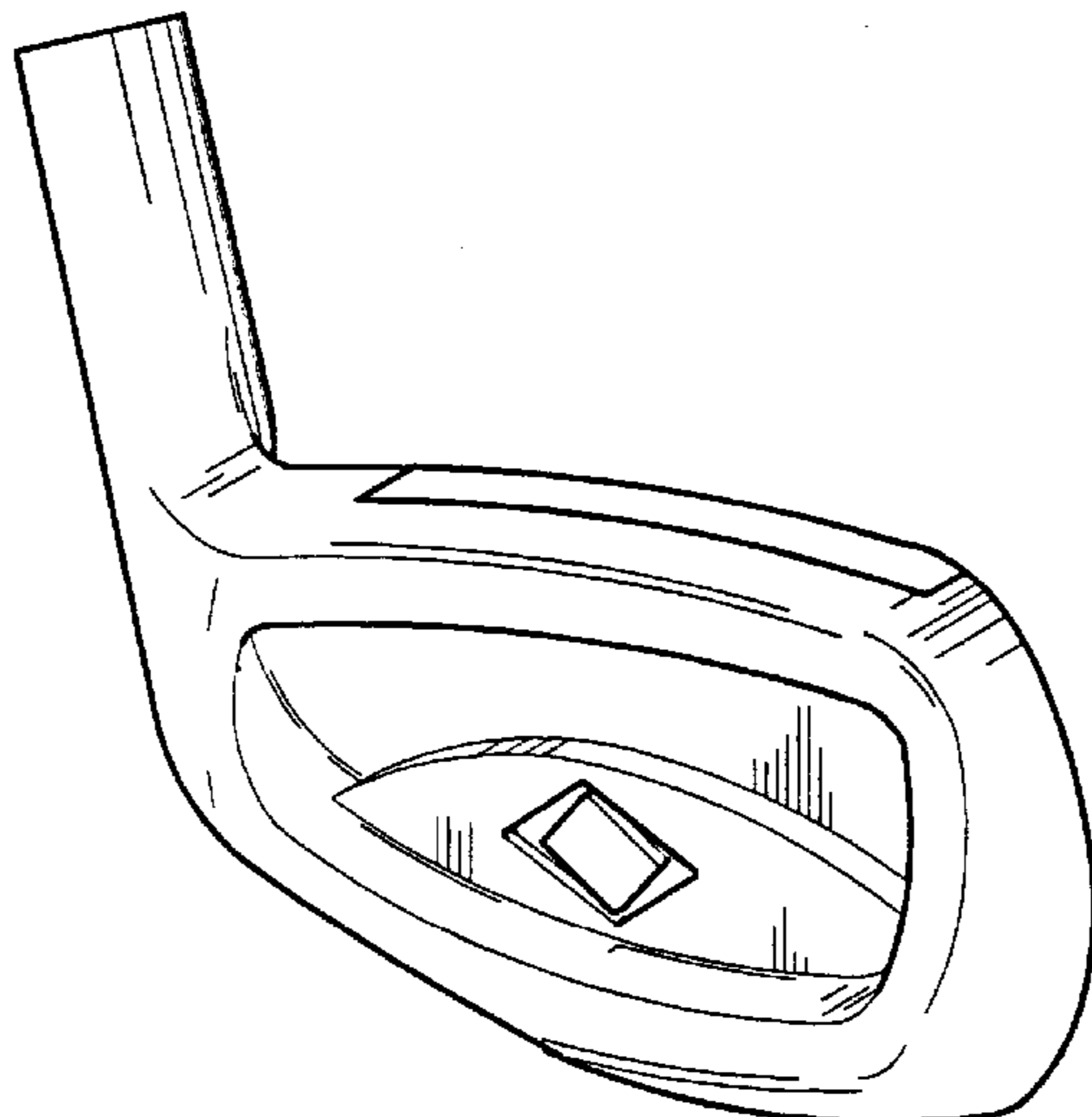
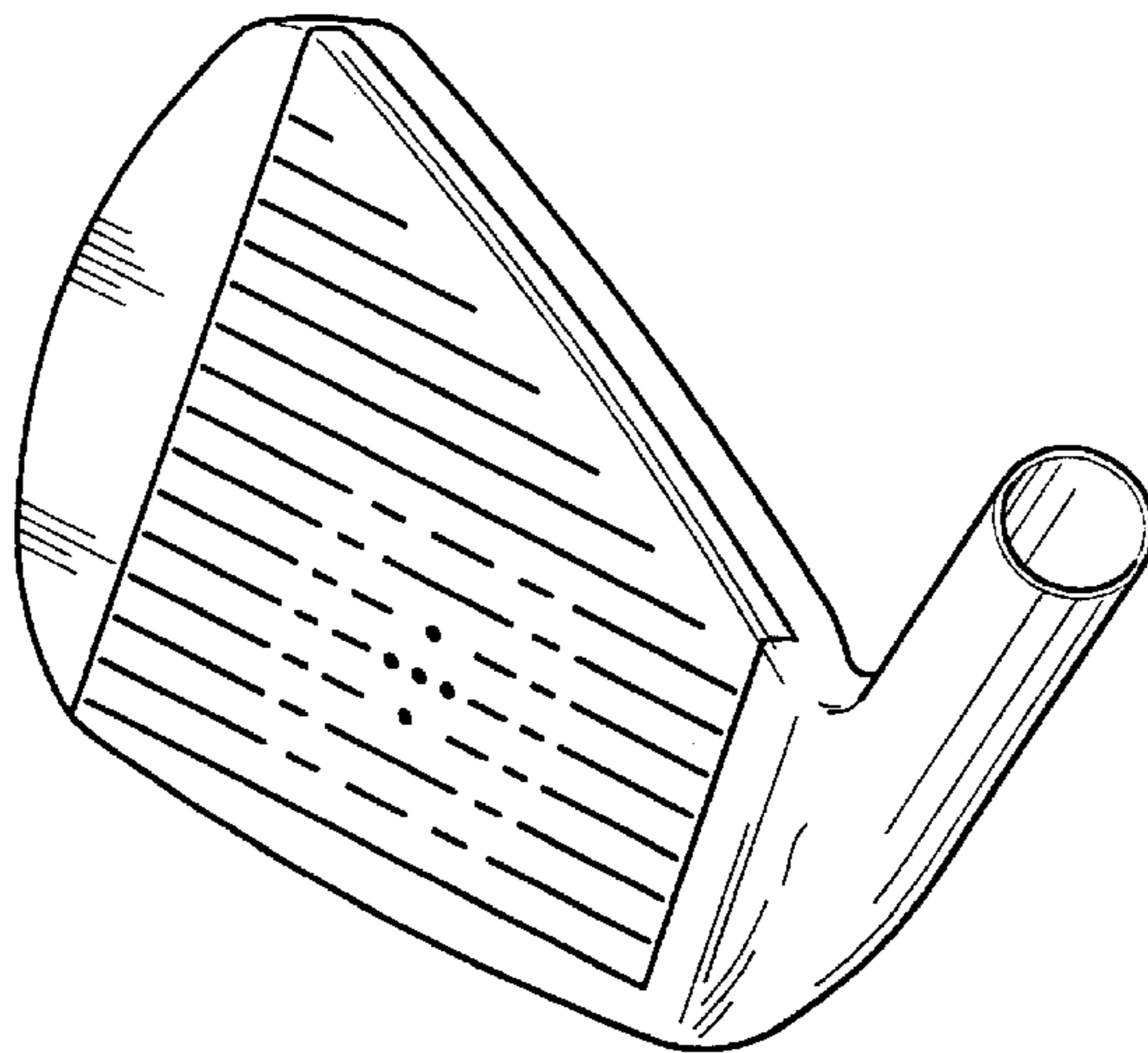

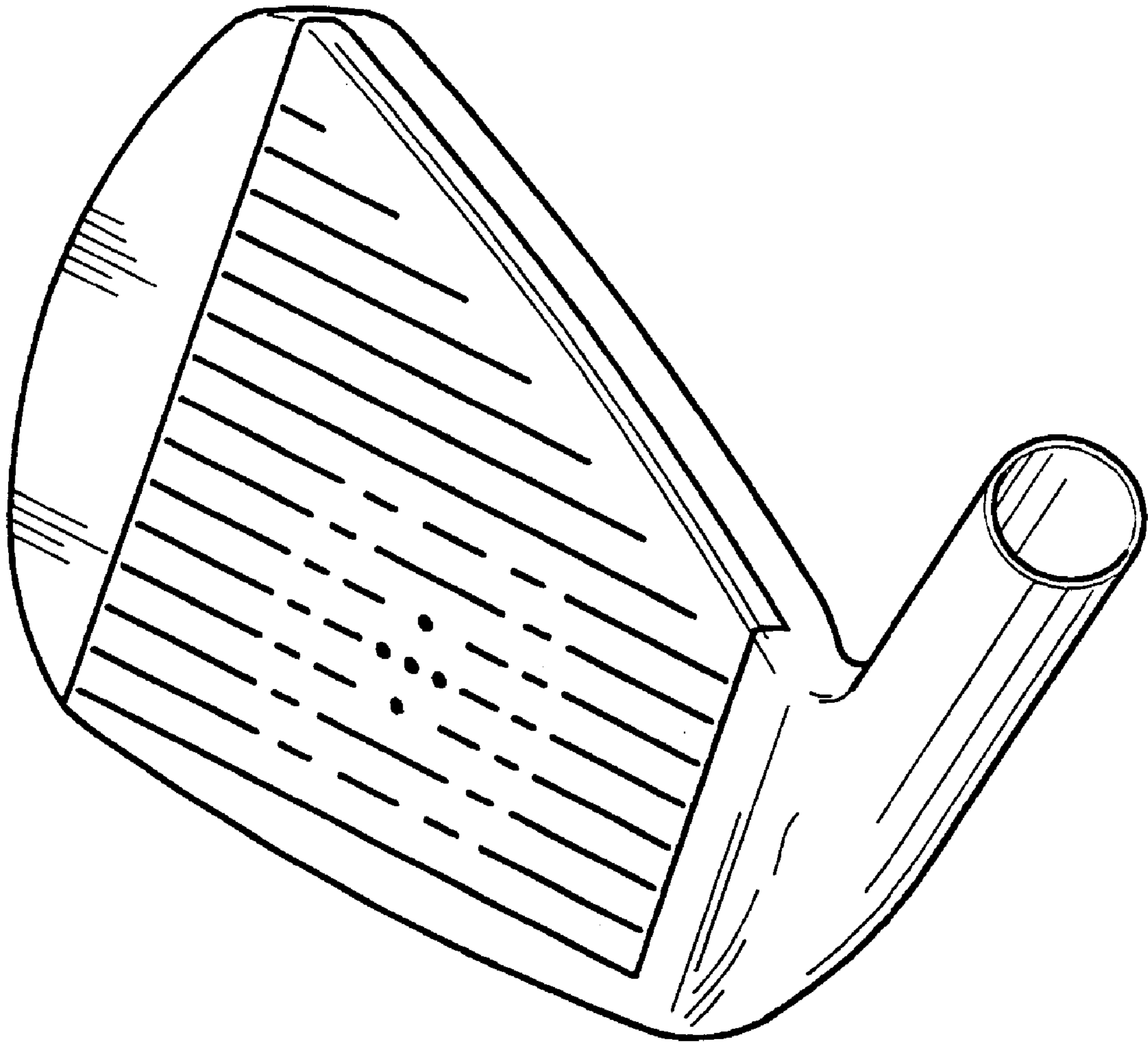

FIG. 1

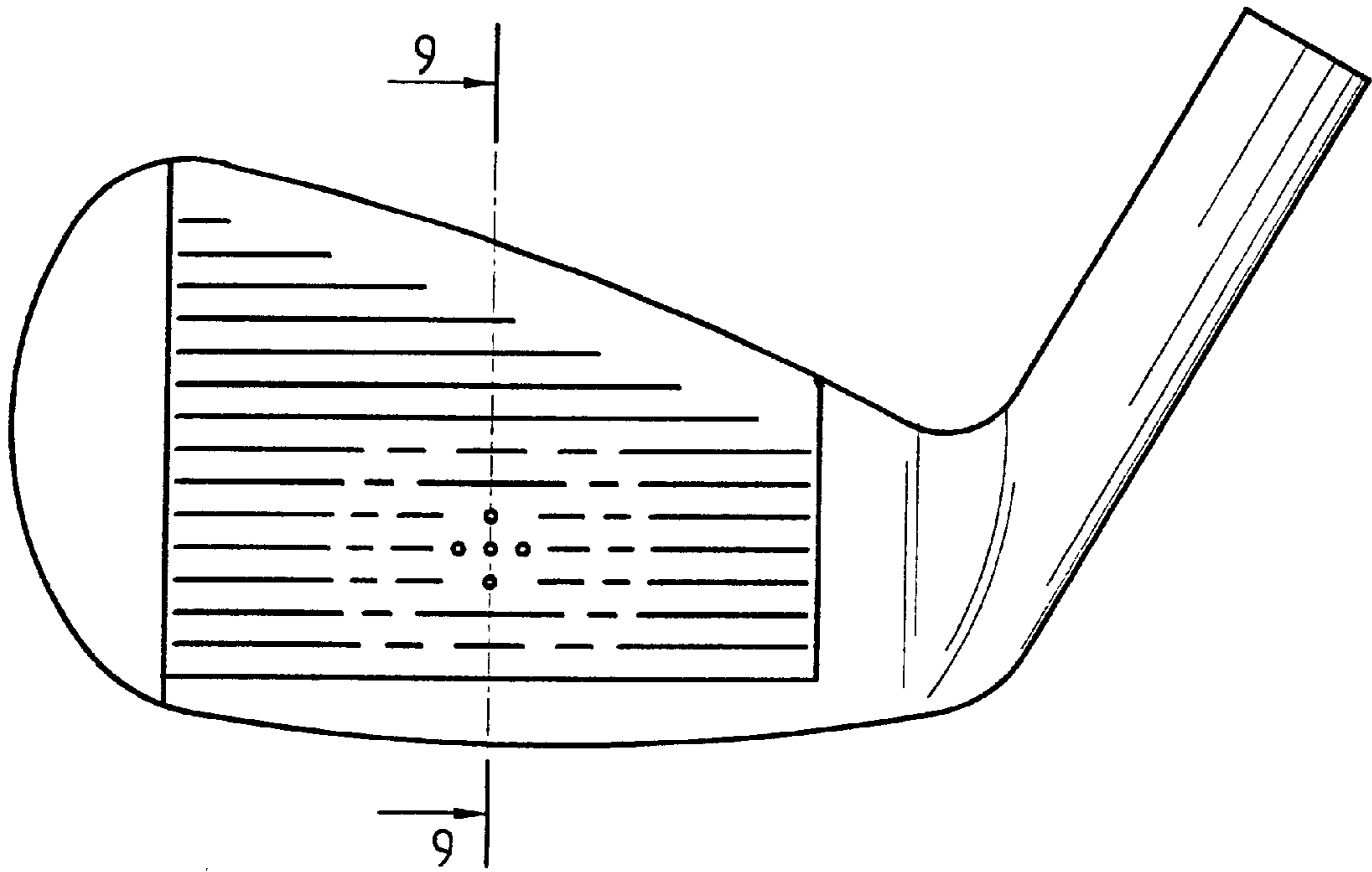

FIG. 2

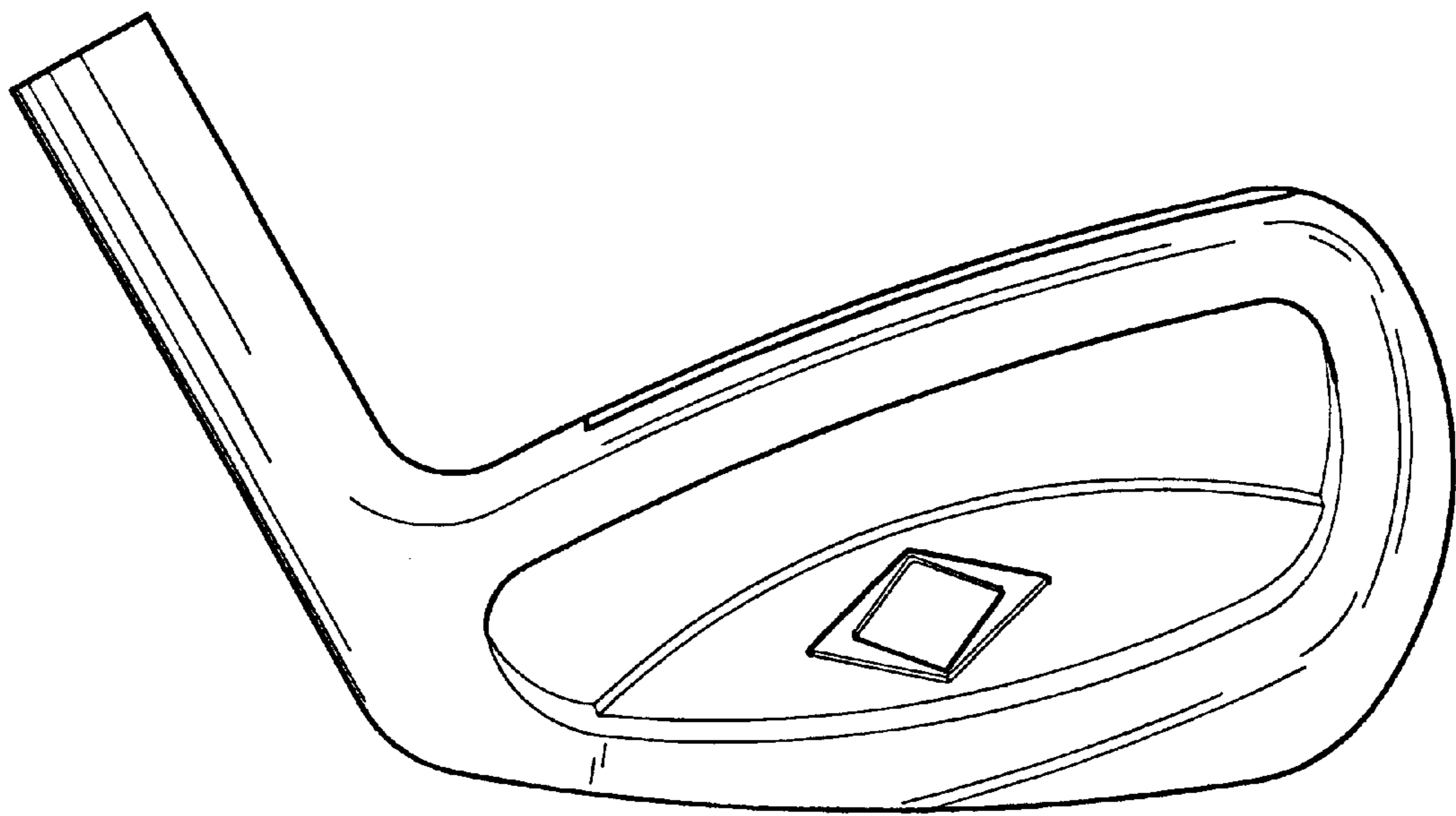

FIG. 3

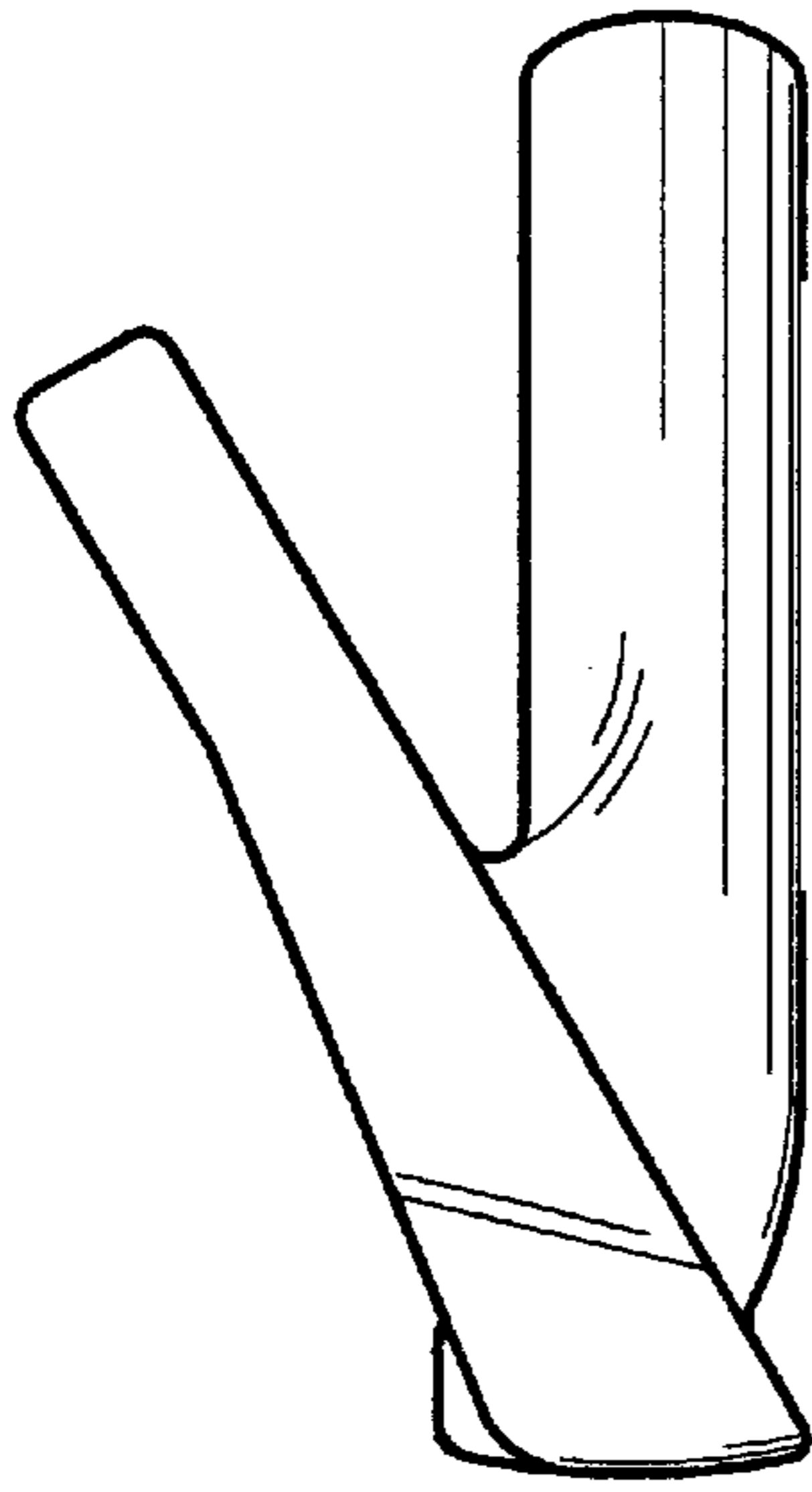

FIG. 4

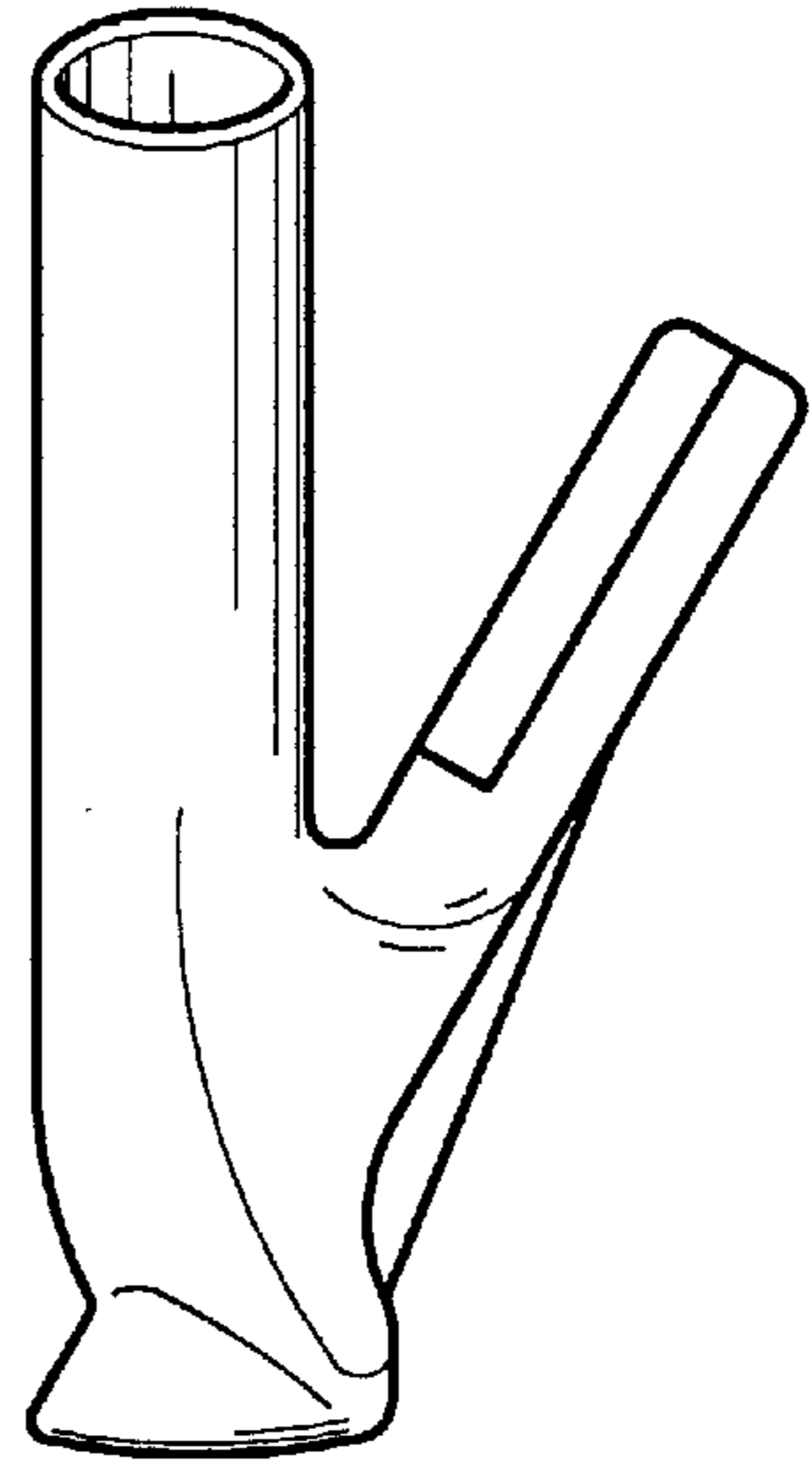

FIG. 5

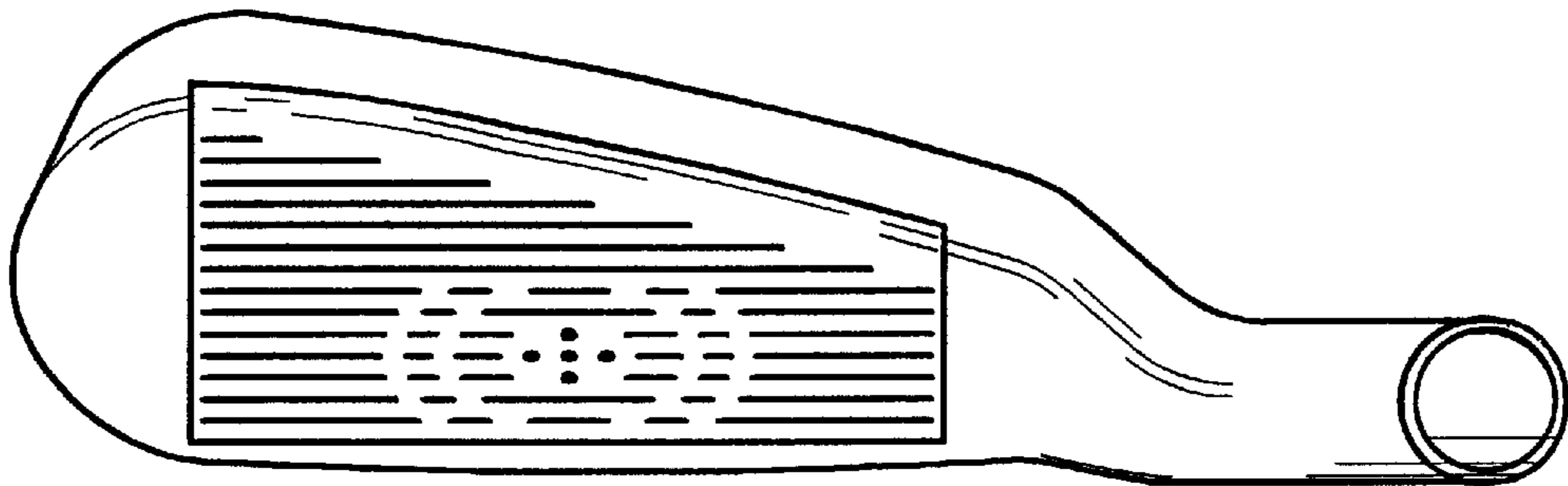

FIG. 6

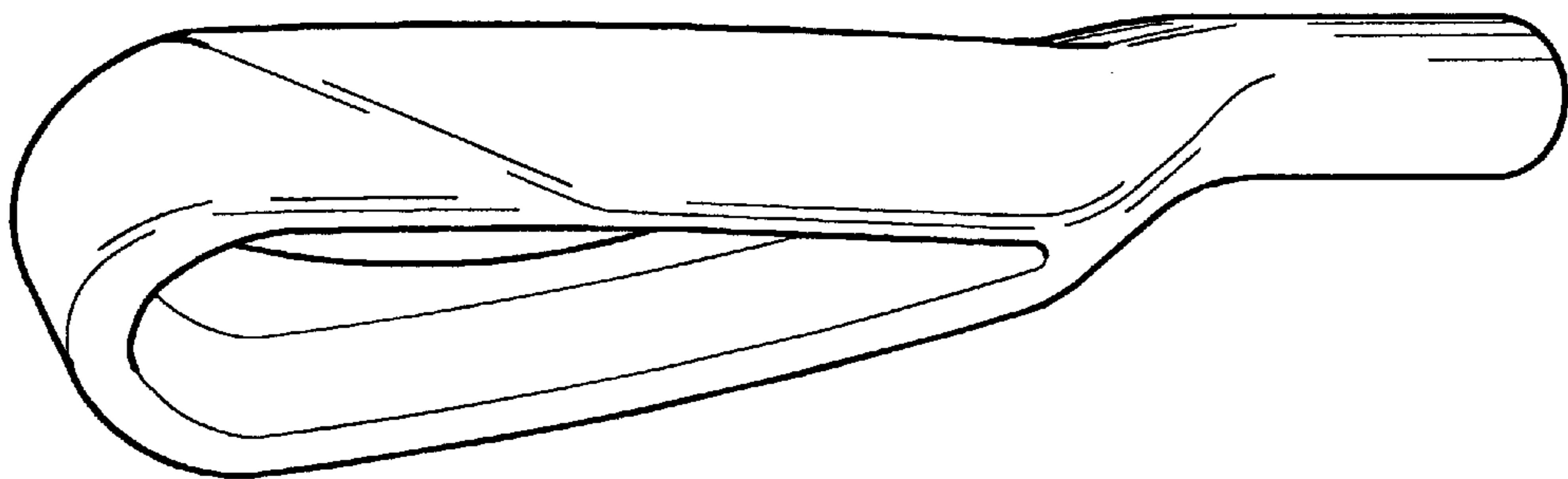

FIG. 7

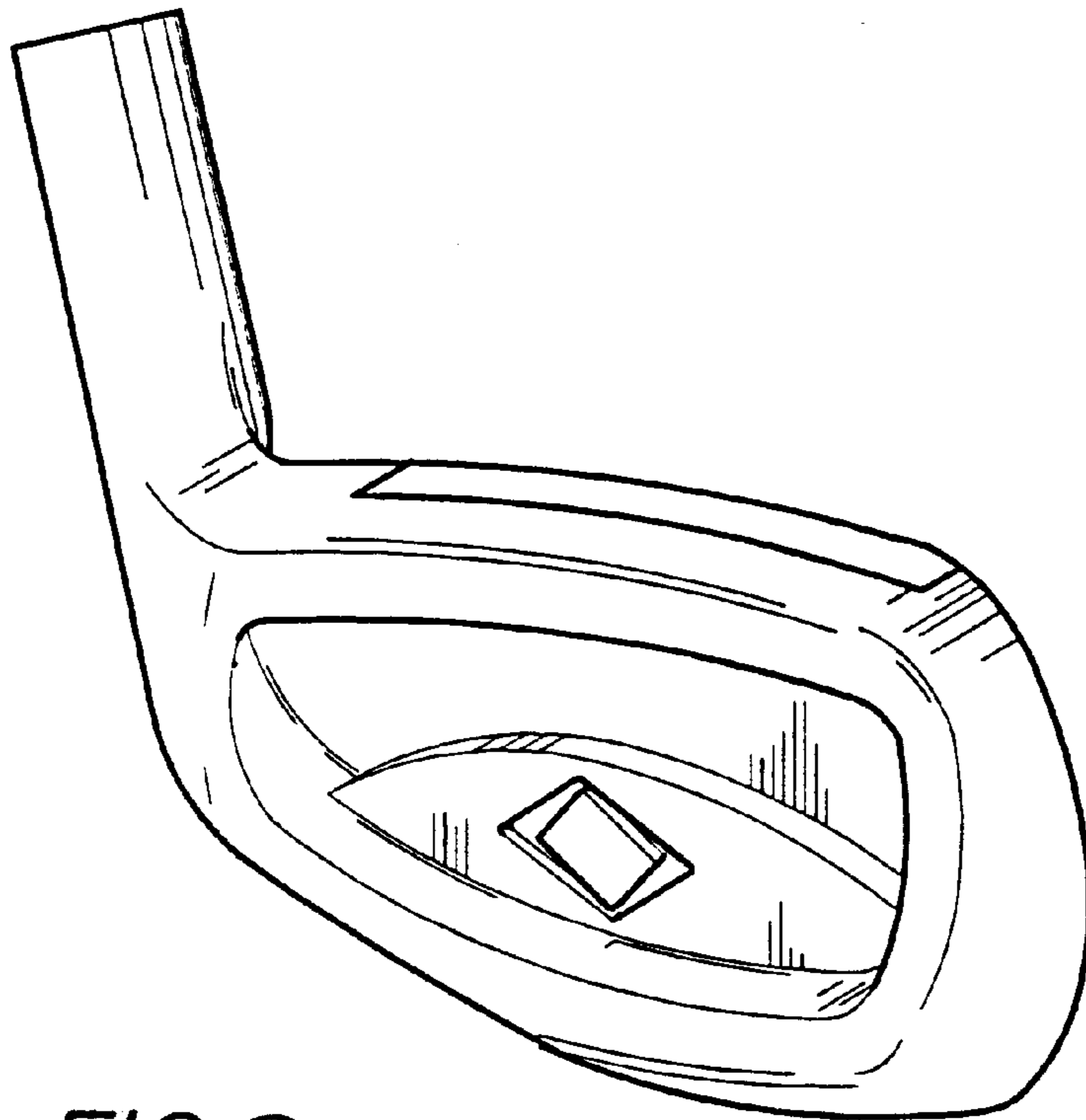

FIG. 8

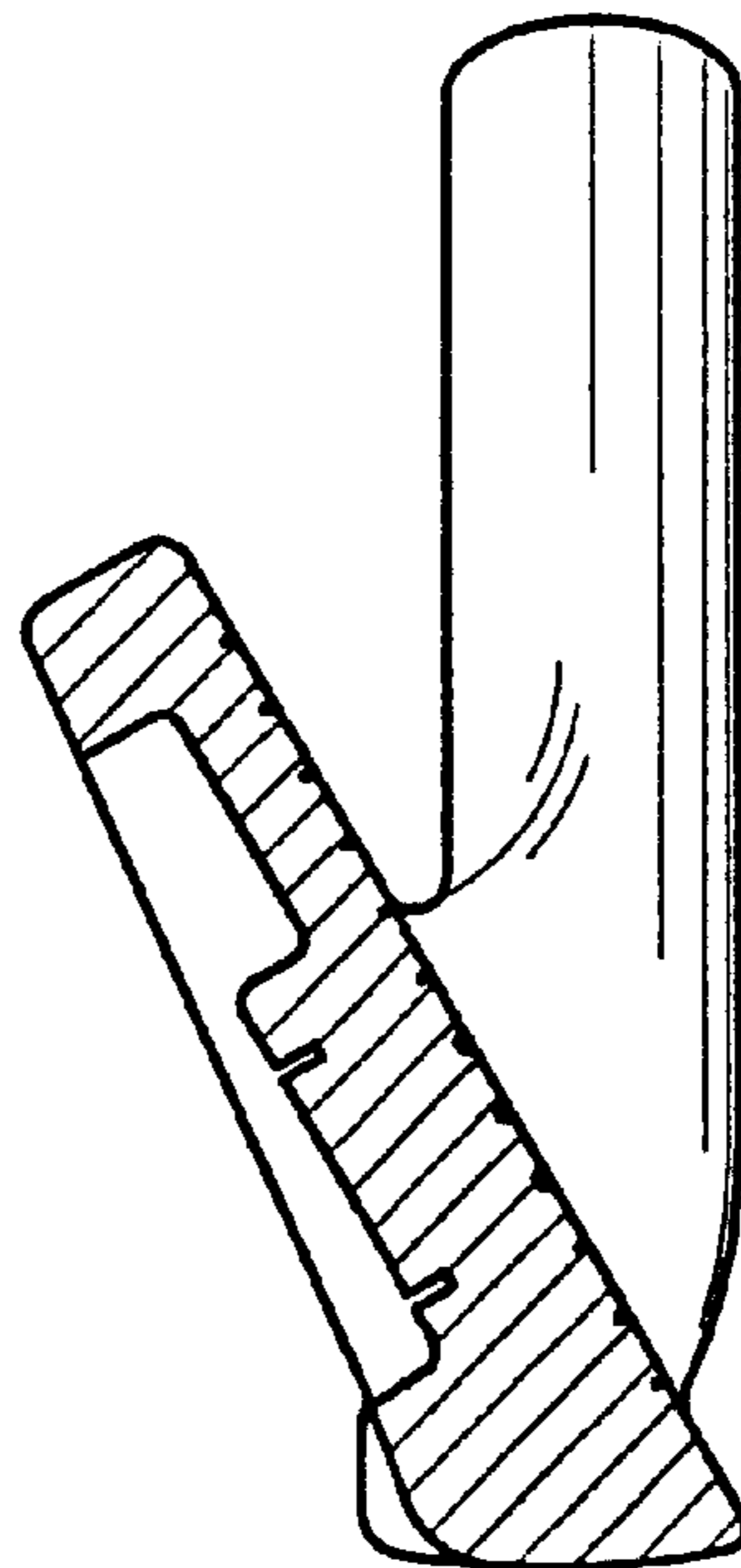

FIG. 9