



US00D413359S

United States Patent [19] Larian

[11] **Patent Number: Des. 413,359**

[45] **Date of Patent: ** Aug. 31, 1999**

[54] **HANDHELD ELECTRONIC FISHING GAME**

OTHER PUBLICATIONS

[75] Inventor: **Isaac Larian**, Los Angeles, Calif.

HongKong Enterprise, p. 135, Oct. 1994.
Miles Kimball Catalog dated Late Spring 1998, Showing a Lunker Bass™ Handheld Computer Fishing Game.

[73] Assignee: **ABC International Traders, Inc.**, North Hills, Calif.

Primary Examiner—Prabhakar Deshmukh
Attorney, Agent, or Firm—Oppenheimer Wolff & Donnelly LLP

[**] Term: **14 Years**

[21] Appl. No.: **29/086,483**

[57] **CLAIM**

[22] Filed: **Apr. 14, 1998**

The ornamental design for handheld electronic fishing game, as shown and described.

[51] **LOC (6) Cl.** **21-01**

[52] **U.S. Cl.** **D21/330**

[58] **Field of Search** D21/324, 329, D21/330, 333; 273/148 B; 463/1, 30-35, 46-52; D22/134, 138, 139, 148

DESCRIPTION

[56] **References Cited**

U.S. PATENT DOCUMENTS

D. 246,049	10/1977	Nakamura	D22/138
D. 343,202	1/1994	Peersmann	D21/324
D. 397,729	9/1998	Schulz et al.	D21/324
D. 399,268	10/1998	Liu	D21/333
D. 400,617	11/1998	Tsai	D21/330
4,969,647	11/1990	Mical et al.	463/46
5,184,830	2/1993	Okada et al.	463/29
5,232,223	8/1993	Dornbusch	273/148 B
5,542,672	8/1996	Meredith	463/37
5,730,655	3/1998	Meredith	463/37

FIG. 1 is a perspective view of a handheld electronic fishing game showing my new design;
FIG. 2 is a front elevational view thereof;
FIG. 3 is a rear elevational view thereof;
FIG. 4 is a right side elevational view thereof;
FIG. 5 is a left side elevational view thereof;
FIG. 6 is a top plan view thereof;
FIG. 7 is a bottom plan view thereof;
FIG. 8 is a rear elevational view of an alternate embodiment of a hand held electronic fishing game, with a belt clip; and,
FIG. 9 is a left side elevational of FIG. 8.
The broken line showing of chain is for illustrative purpose only and forms no part of the claimed design.

1 Claim, 5 Drawing Sheets

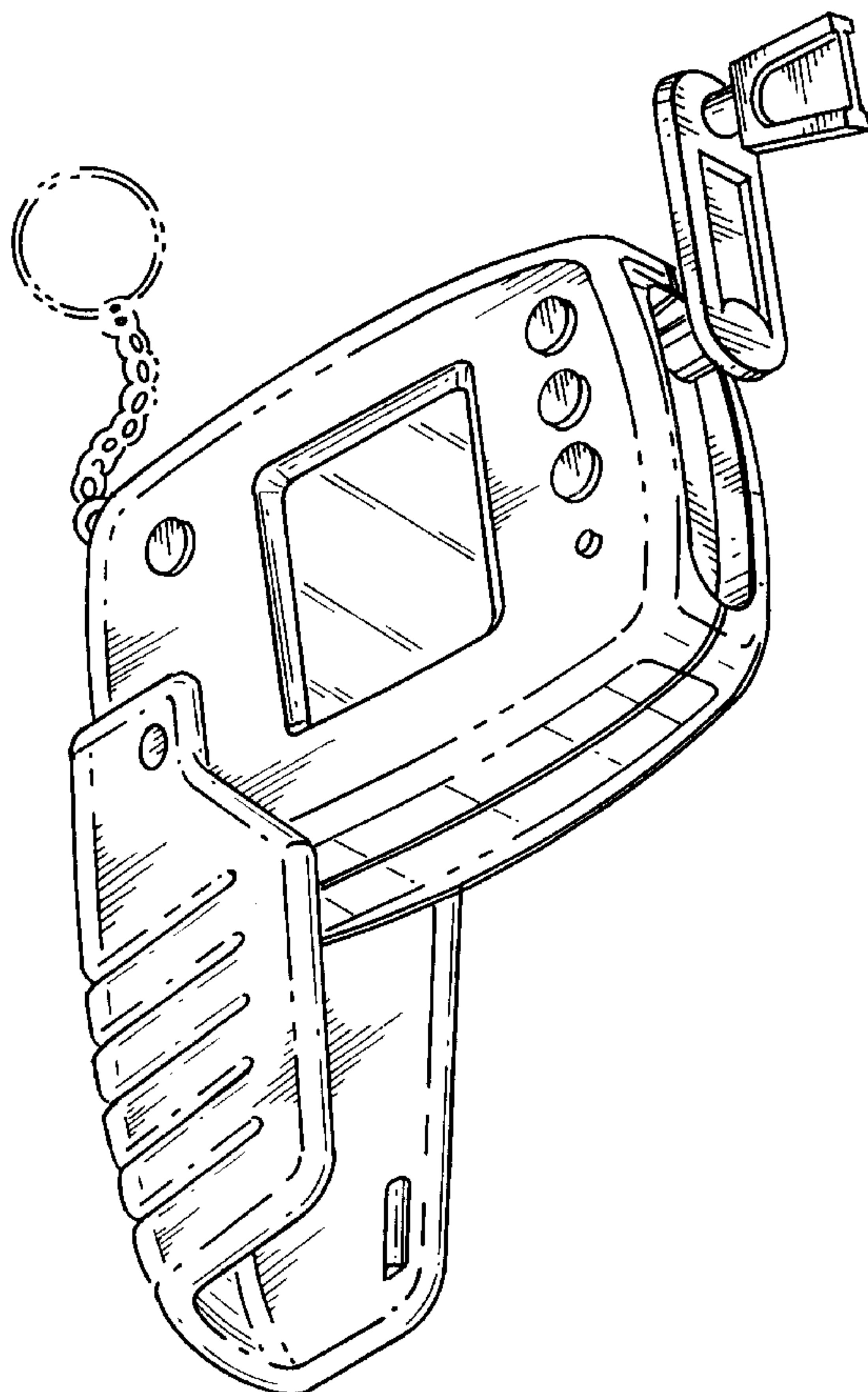
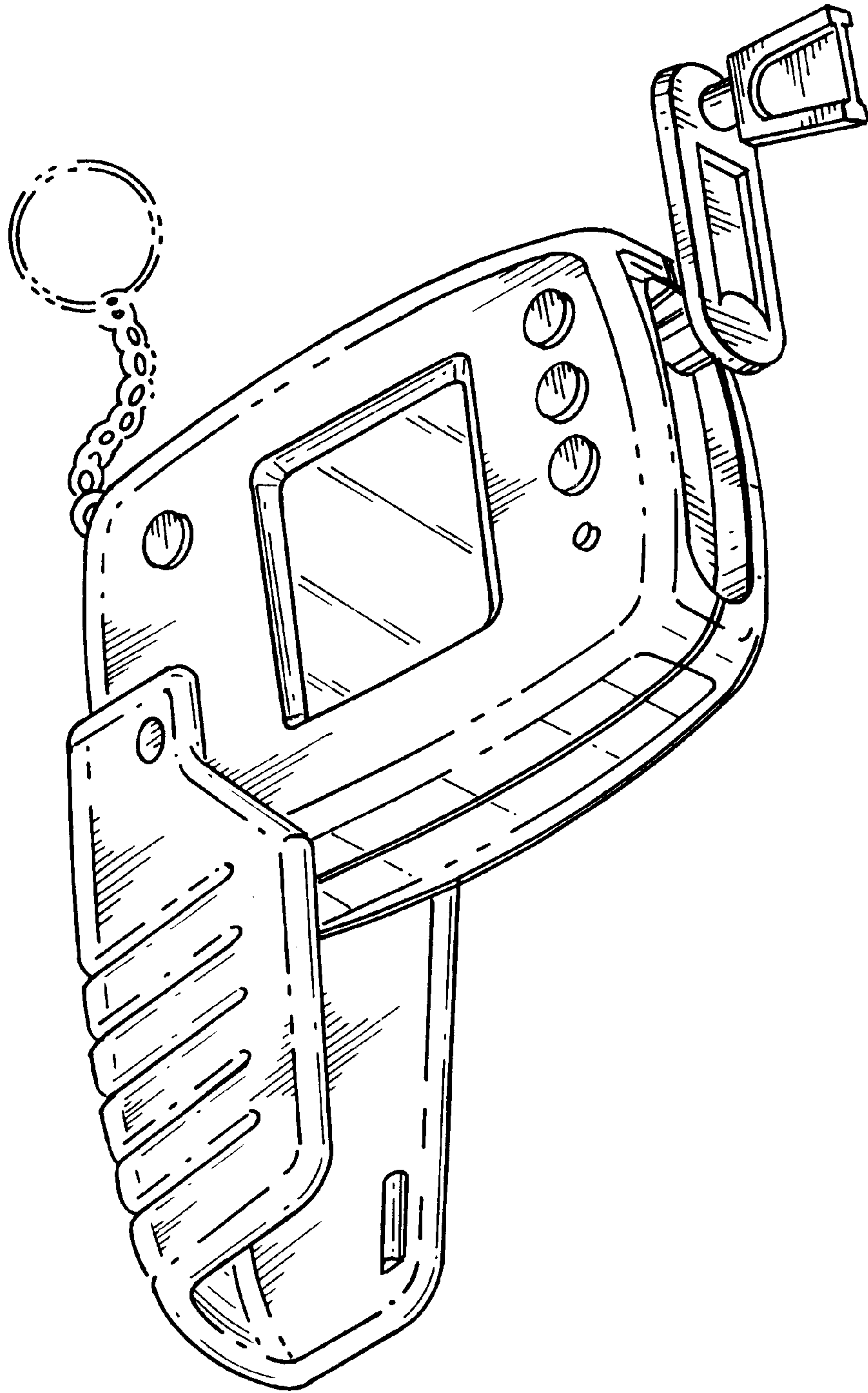

FIG. 1



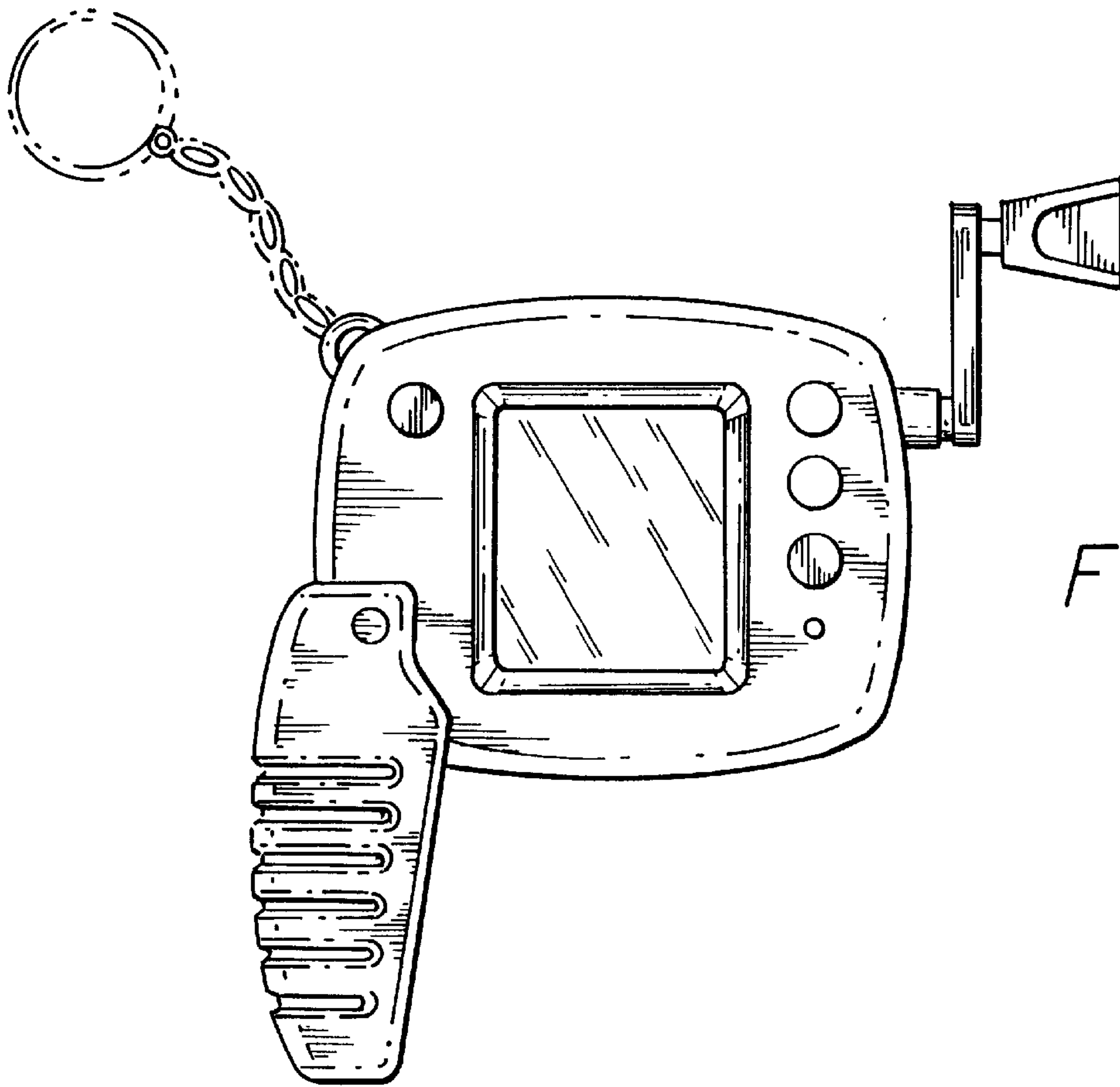

FIG. 2

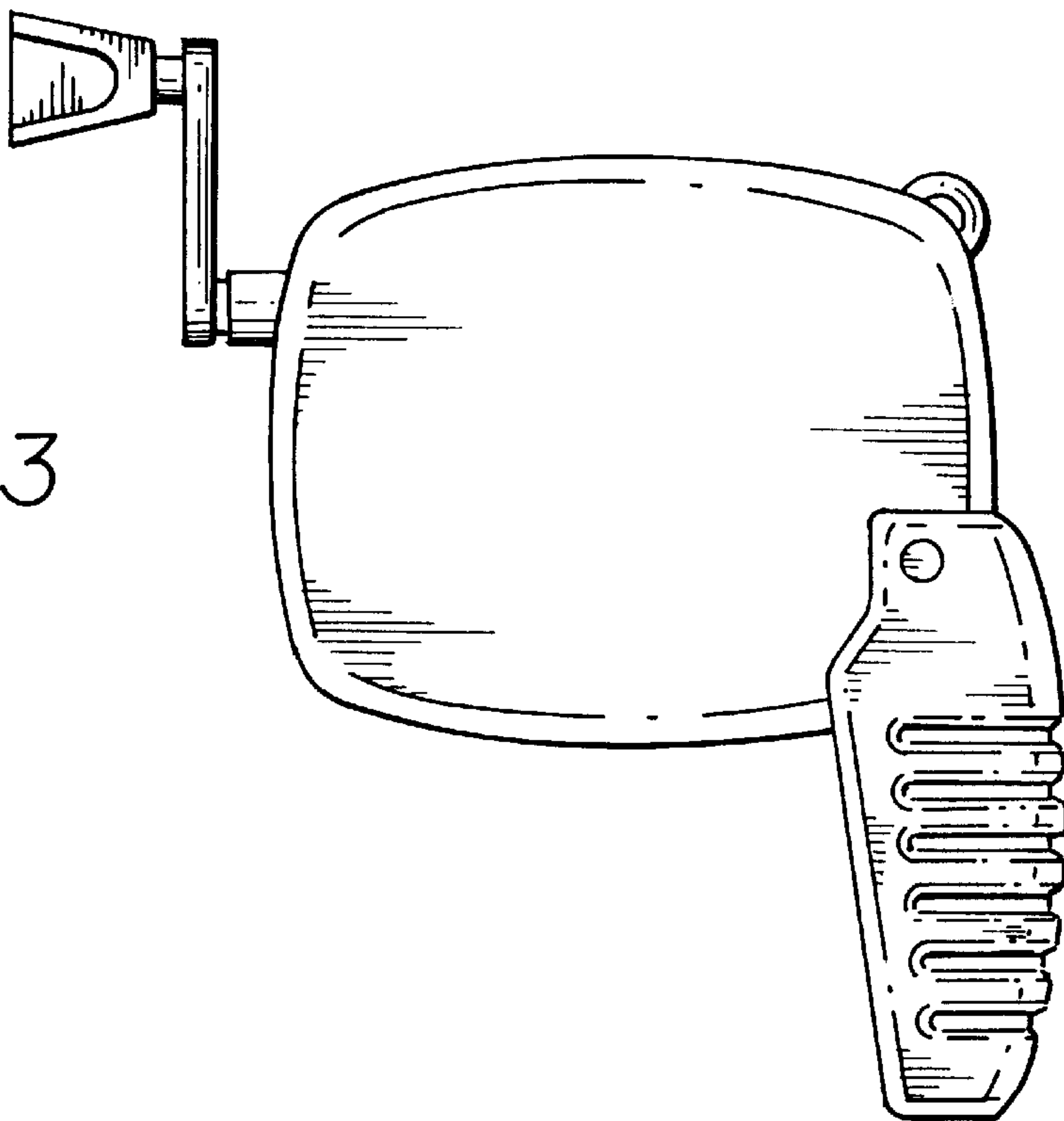

FIG. 3

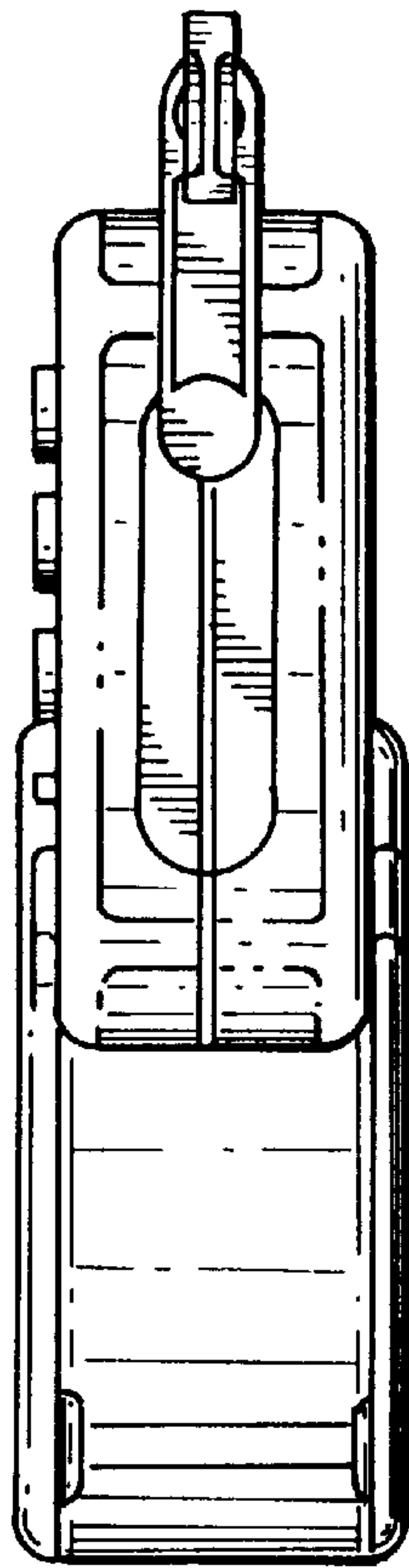

FIG. 4

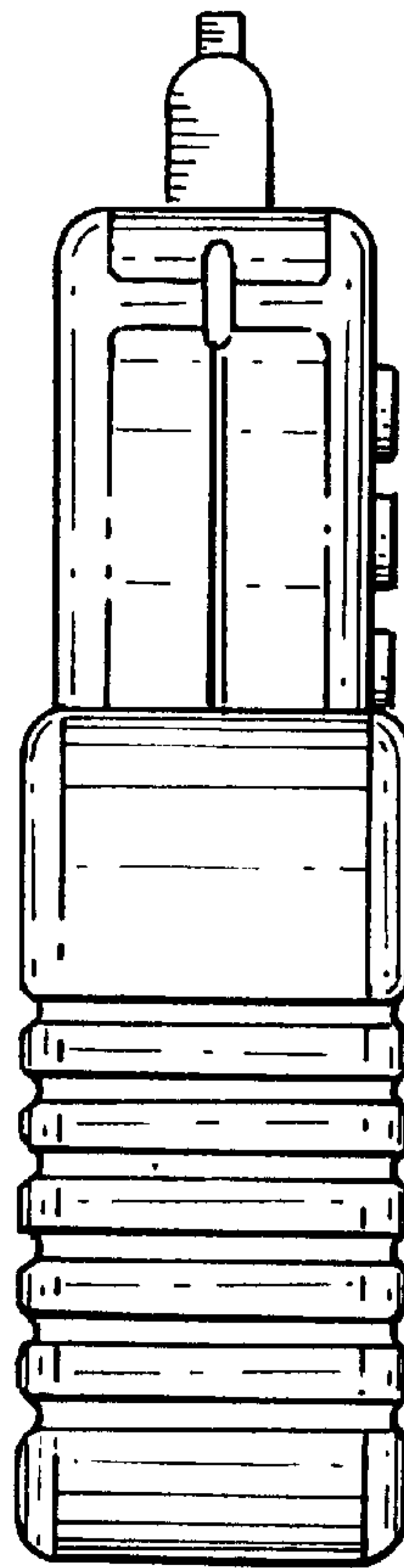

FIG. 5

FIG. 6

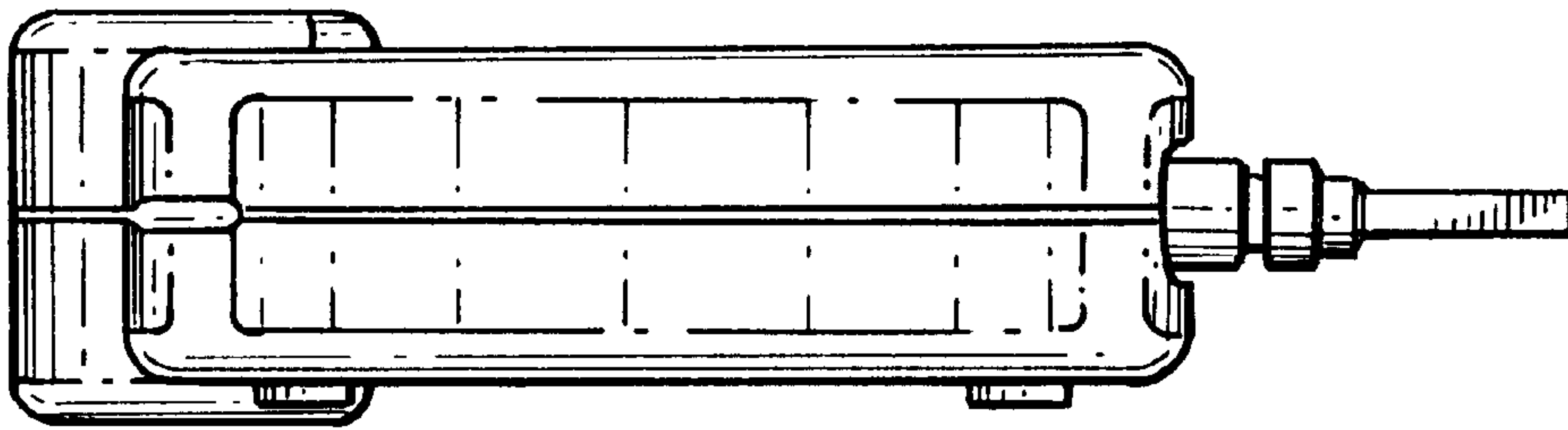

FIG. 7

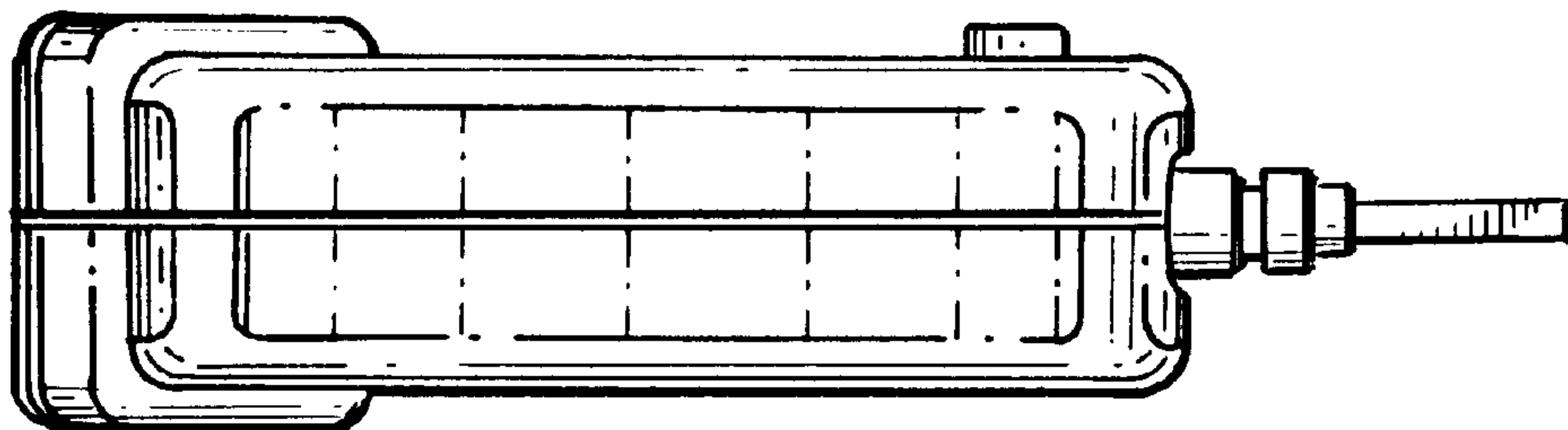

FIG. 8

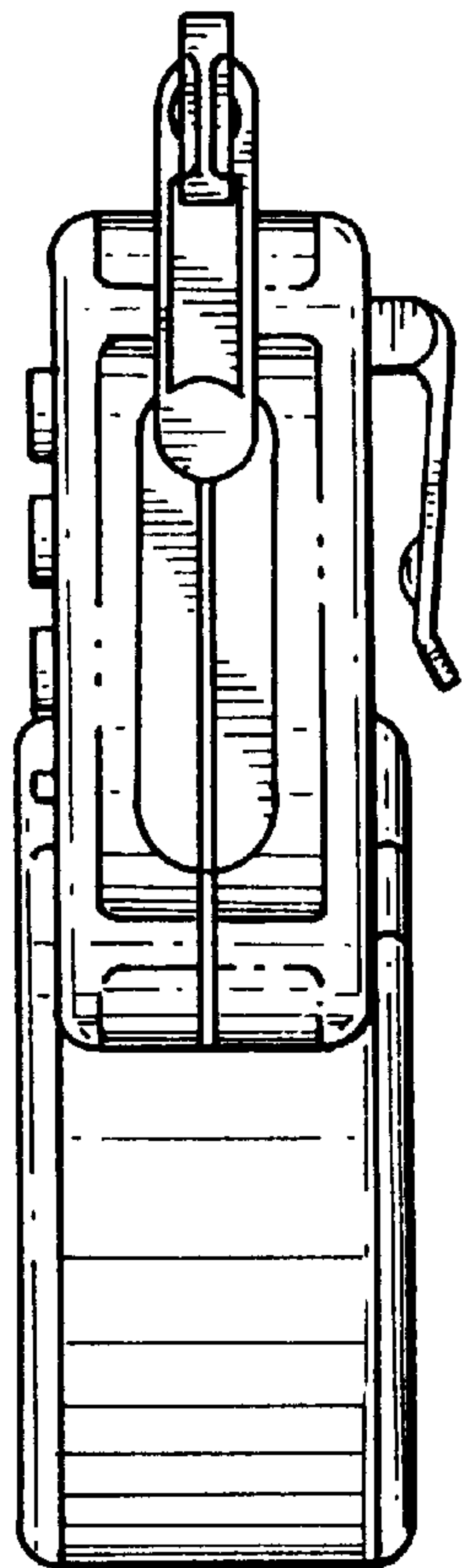
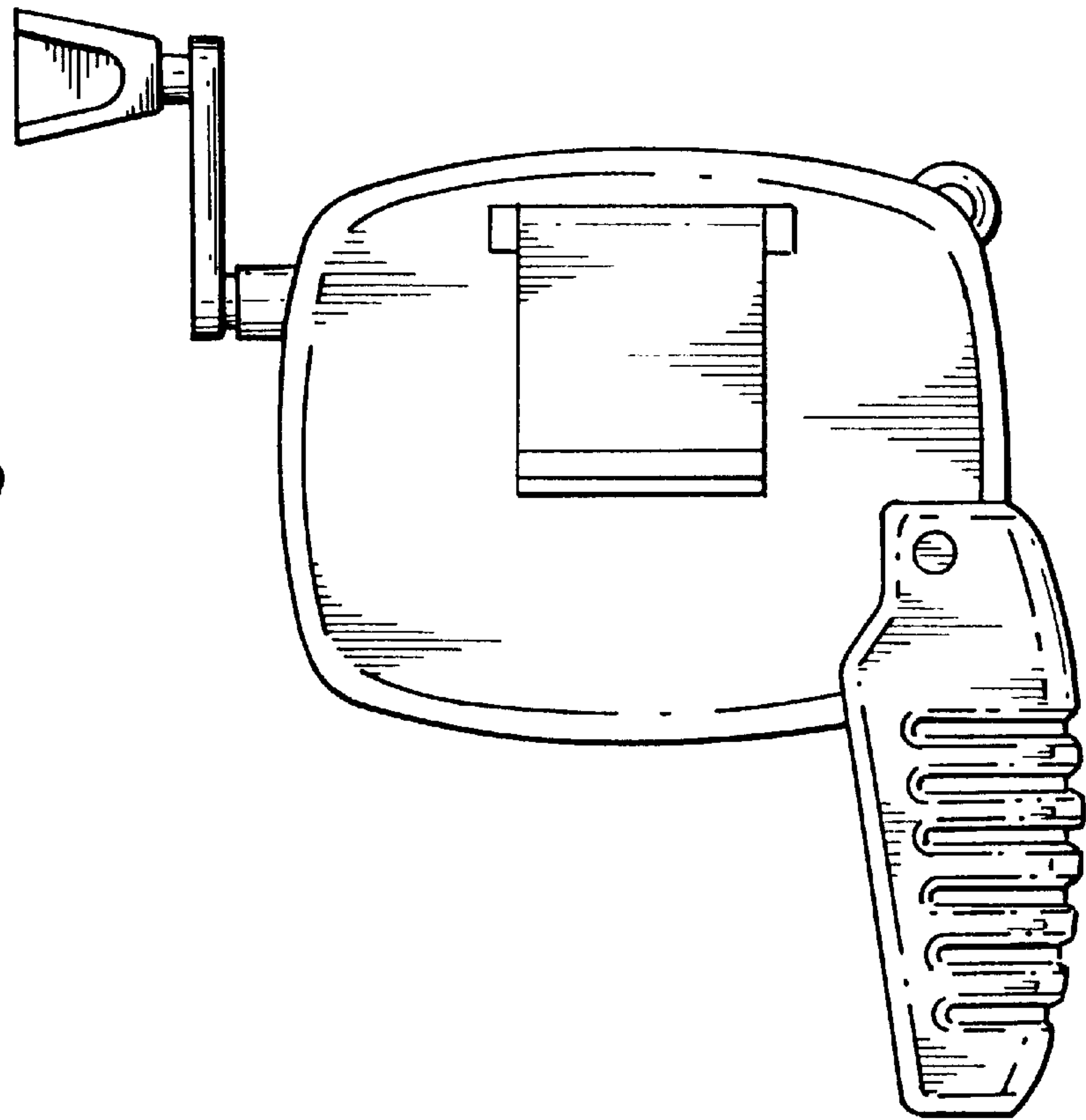

FIG. 9