



US00D413300S

United States Patent [19] Igarashi

[11] **Patent Number: Des. 413,300**

[45] **Date of Patent: ** Aug. 31, 1999**

[54] **BATTERY PACK FOR PRINTER**

D. 349,484 8/1994 Kuzumoto et al. D13/103
D. 361,309 8/1995 White D13/103
5,293,300 3/1994 Leung 429/98

[75] Inventor: **Masaaki Igarashi**, Tokyo, Japan

[73] Assignee: **Canon Kabushiki Kaisha**, Tokyo, Japan

[**] Term: **14 Years**

Primary Examiner—Joel Sincavage
Attorney, Agent, or Firm—Fitzpatrick, Cella, Harper & Scinto

[21] Appl. No.: **29/093,429**

[22] Filed: **Sep. 10, 1998**

[57] **CLAIM**

The ornamental design for a battery pack for printer, as shown and described.

[30] **Foreign Application Priority Data**

Mar. 18, 1998 [JP] Japan 10-007505

DESCRIPTION

[51] **LOC (6) Cl.** **13-02**

[52] **U.S. Cl.** **D13/103**

[58] **Field of Search** D13/103; 429/96-100,
429/163, 176

FIG. 1 is a front view of a battery pack for printer showing my new design;
FIG. 2 is a rear view thereof;
FIG. 3 is a top plan view thereof;
FIG. 4 is a bottom plan view thereof;
FIG. 5 is a left side view thereof;
FIG. 6 is a right side view thereof; and,
FIG. 7 is a perspective view thereof.

[56] **References Cited**

U.S. PATENT DOCUMENTS

D. 346,581 5/1994 Tattari D13/103

1 Claim, 3 Drawing Sheets

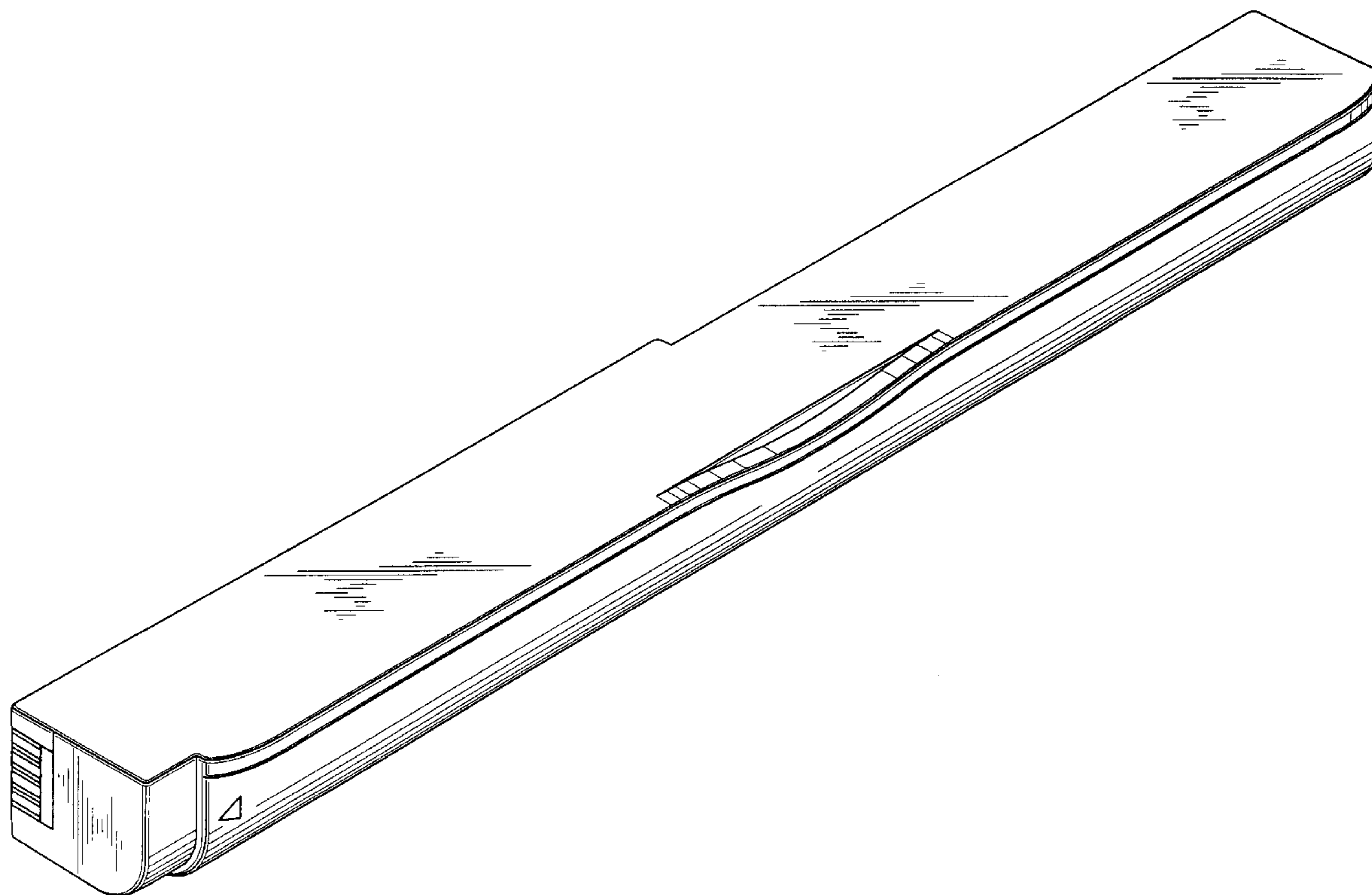

FIG. 1

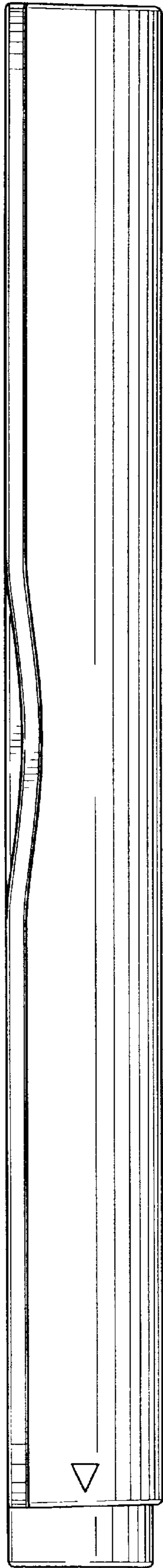

FIG. 2

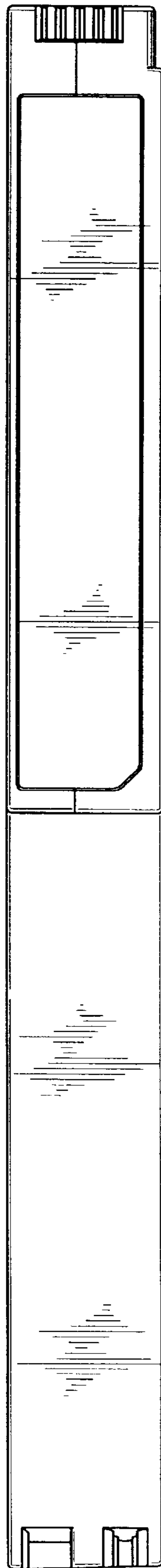

FIG. 3

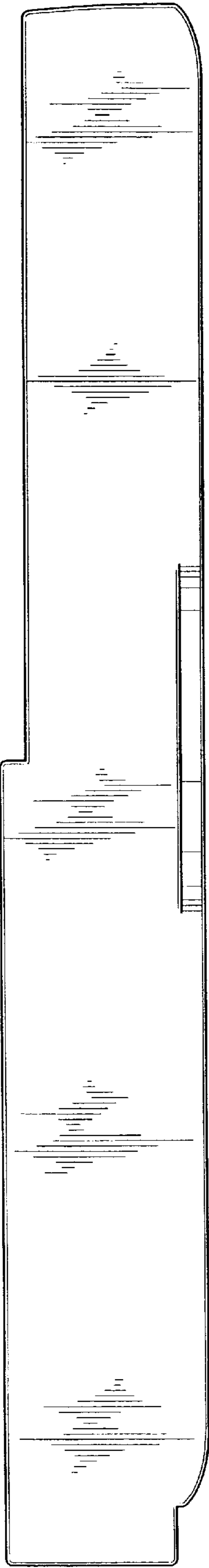

FIG. 4

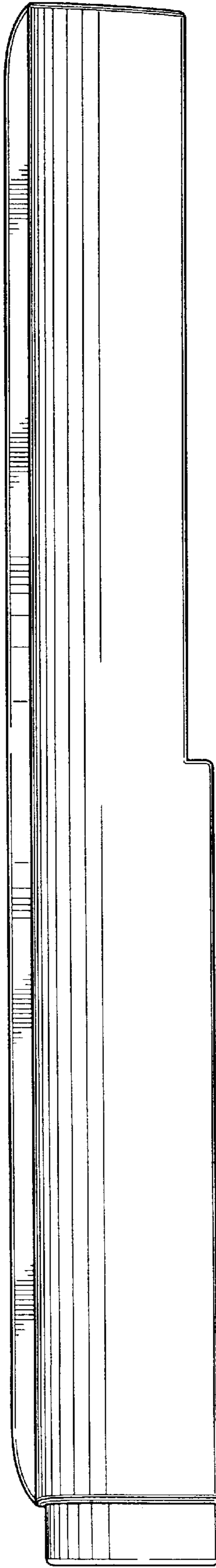

FIG. 5

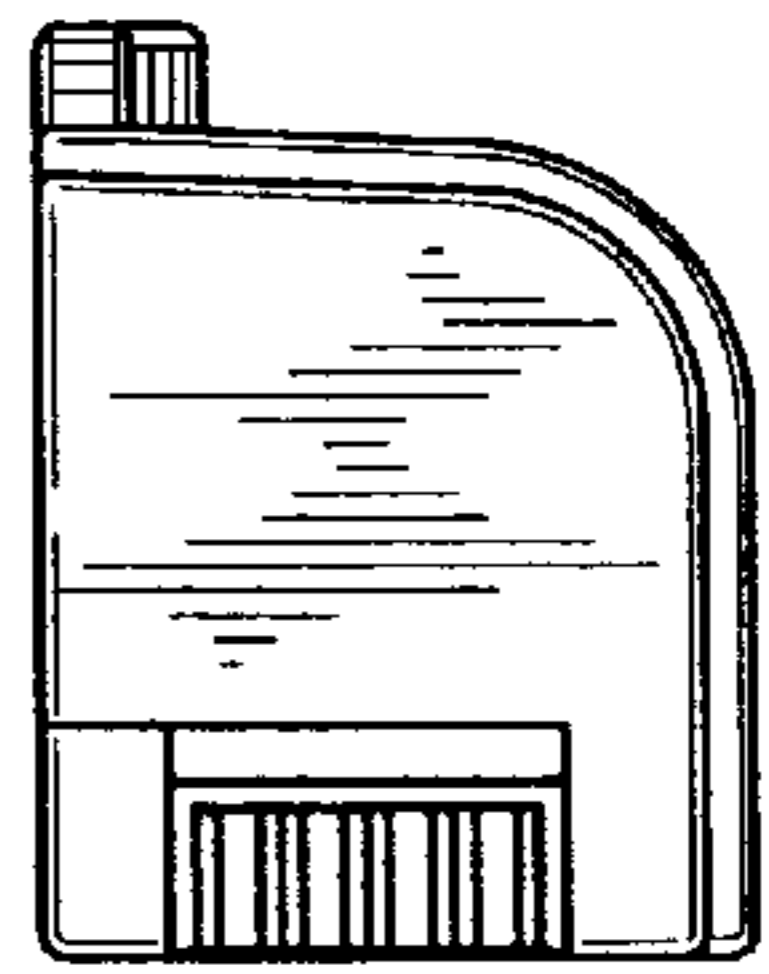
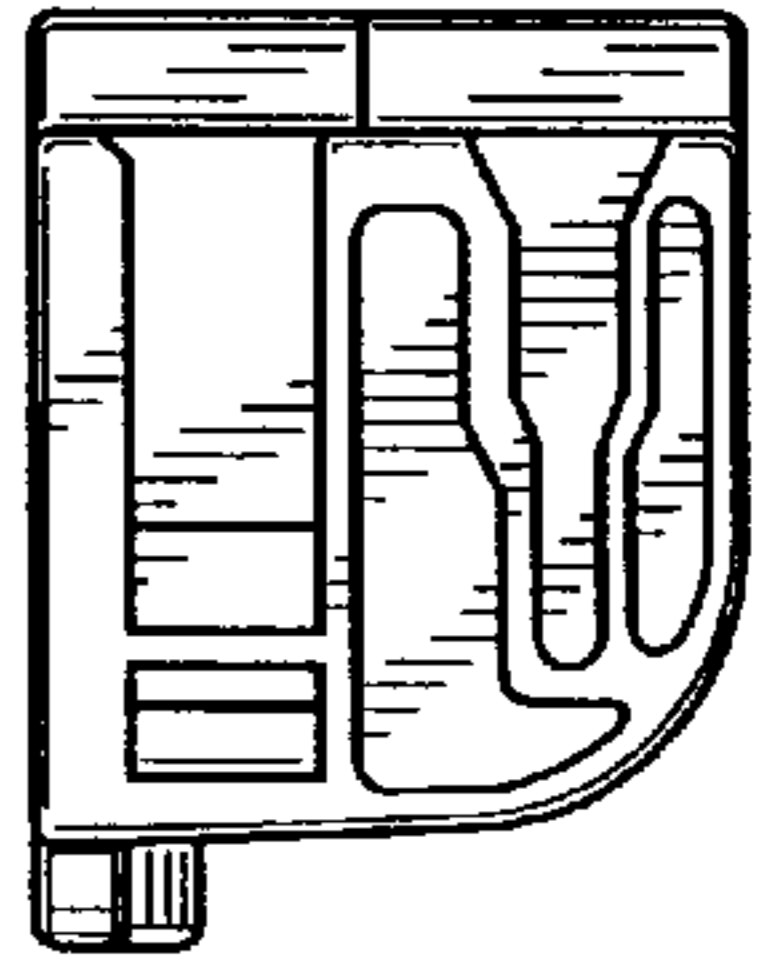

FIG. 6



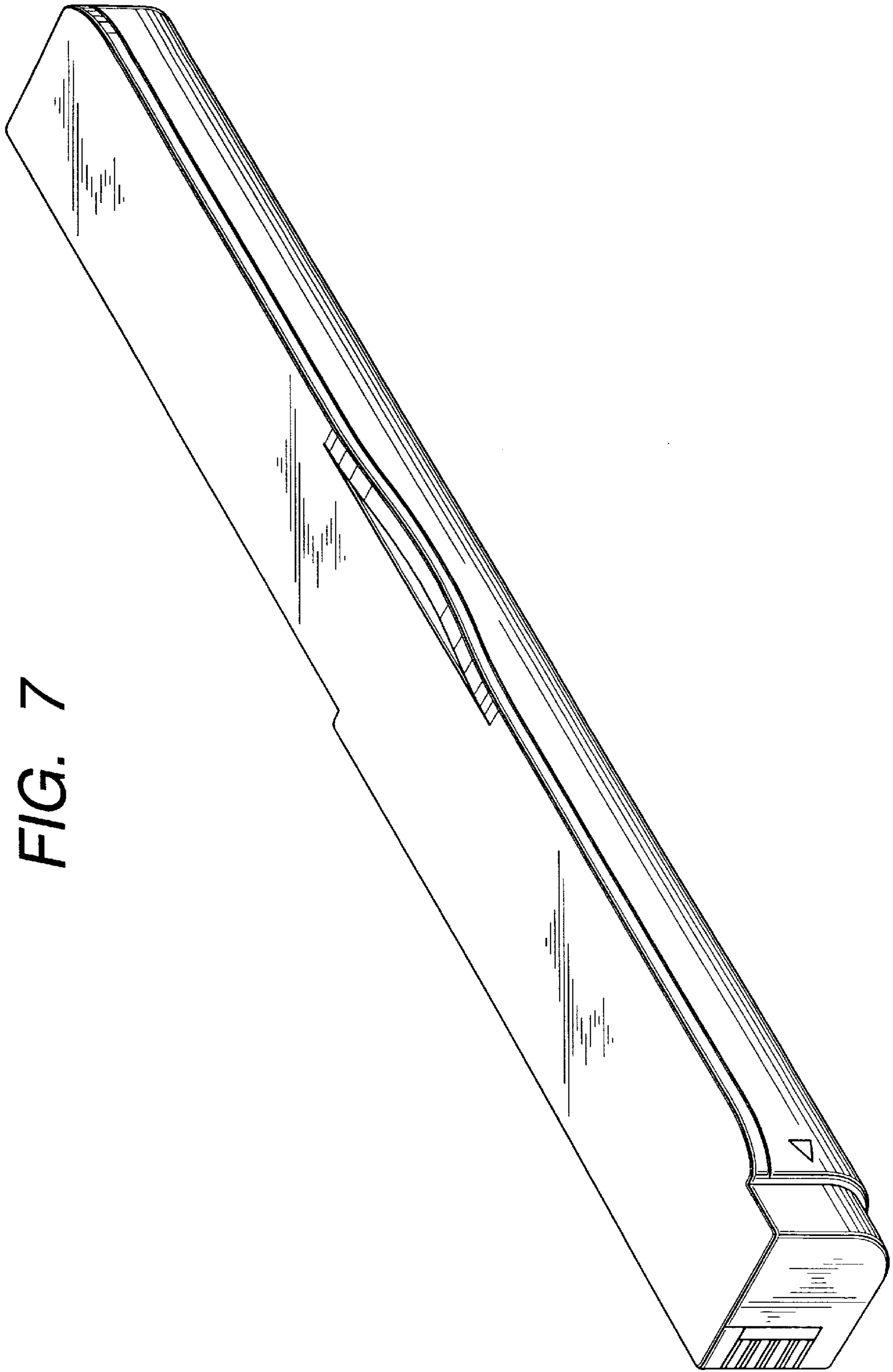

FIG. 7