



US00D413280S

United States Patent [19]

Weiss et al.

[11] Patent Number: Des. 413,280

[45] Date of Patent: ** Aug. 31, 1999

[54] NOVELTY BATH TUB

D. 406,546 3/1999 Burrows et al. D11/160

[75] Inventors: **Adrienne Weiss**, Los Angeles, Calif.;
Rizal Oei, Scottsdale, Ariz.

Primary Examiner—Dominic Simone
Attorney, Agent, or Firm—Blackwell Sanders Peper Martin

[73] Assignee: **Build-A-Bear Workshop, L.L.C.**, St. Louis, Mo.

[57] CLAIM

[**] Term: 14 Years

The ornamental design for a novelty bath tub, as shown and described.

[21] Appl. No.: 29/095,486

[22] Filed: Oct. 23, 1998

DESCRIPTION

[51] LOC (6) Cl. 11-02

[52] U.S. Cl. D11/157

[58] Field of Search D11/131, 121,
D11/157; D21/398, 572; 428/913.3

FIG. 1 is a perspective view of a novelty bath tub showing our new design;

FIG. 2 is a top plan view thereof;

FIG. 3 is a front elevational view thereof;

FIG. 4 is a back elevational view thereof;

FIG. 5 is an end elevational view thereof; and,

FIG. 6 is an end elevational view of the opposite end.

Throughout the figures lines drawn in phantom are for illustrative purposes only and form no part of the claimed design.

[56] References Cited

U.S. PATENT DOCUMENTS

D. 185,800 8/1959 Brooks D11/160
D. 372,207 7/1996 Cohen D11/121 X

1 Claim, 3 Drawing Sheets

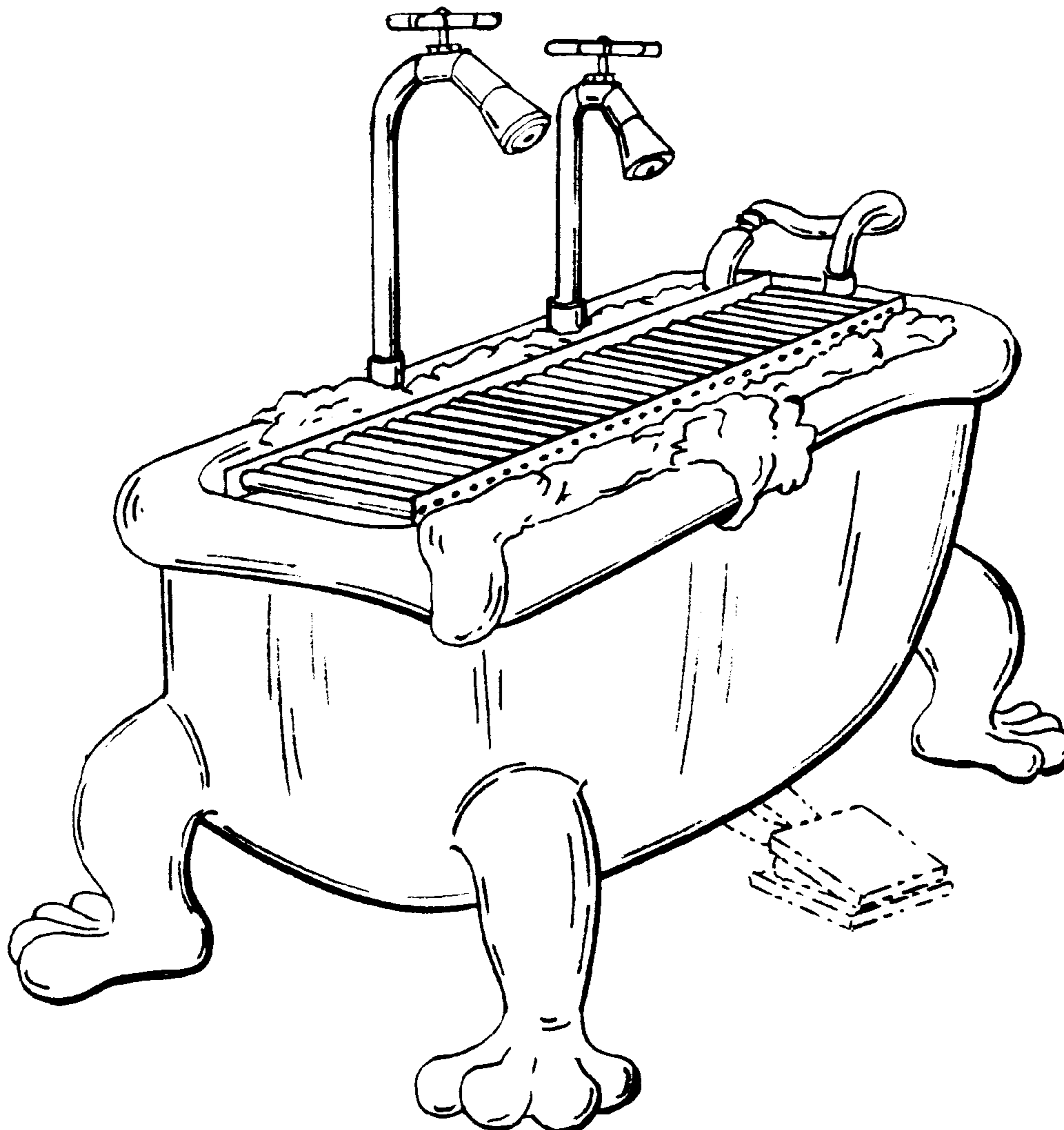

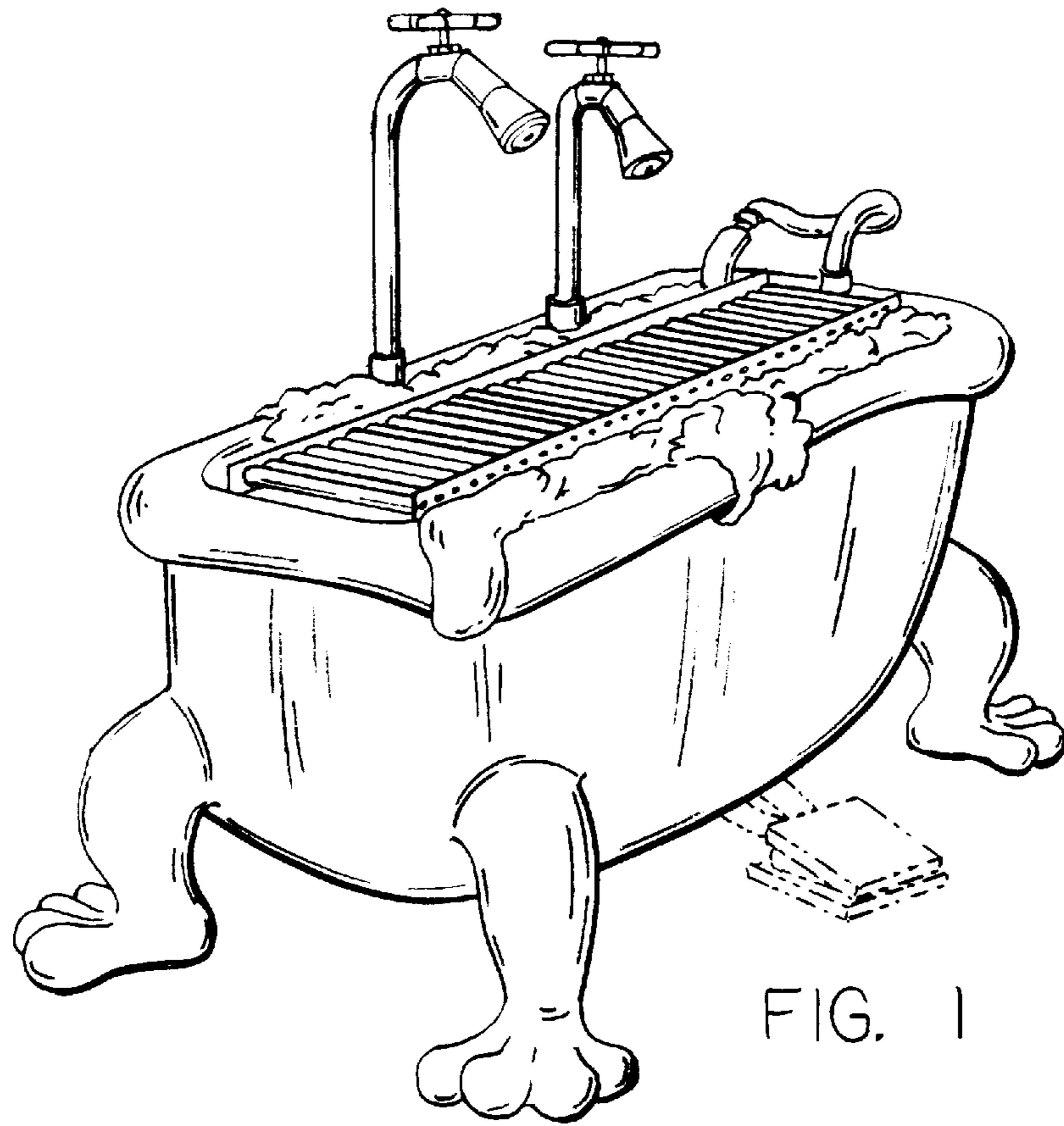

FIG. 1

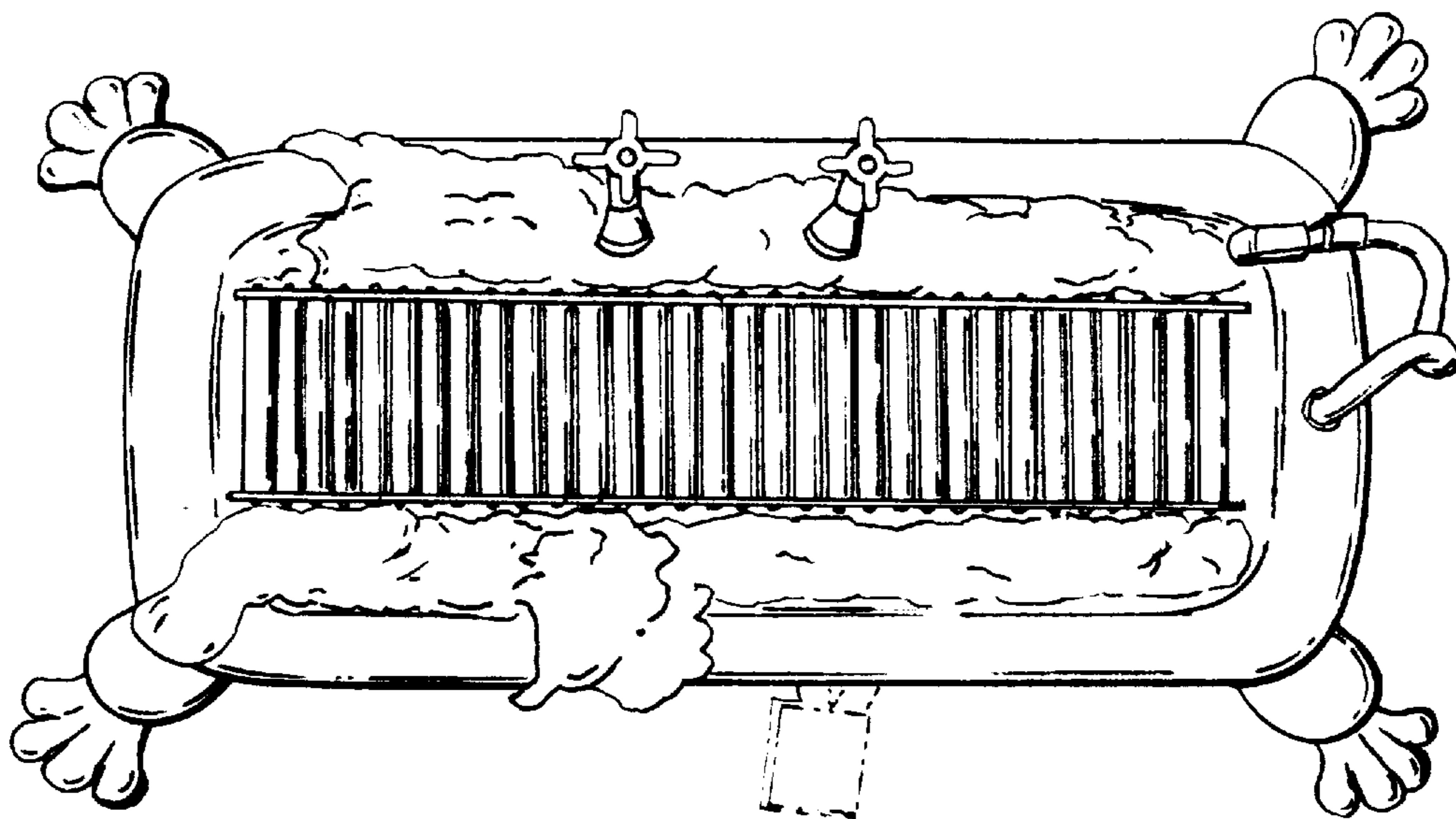

FIG. 2

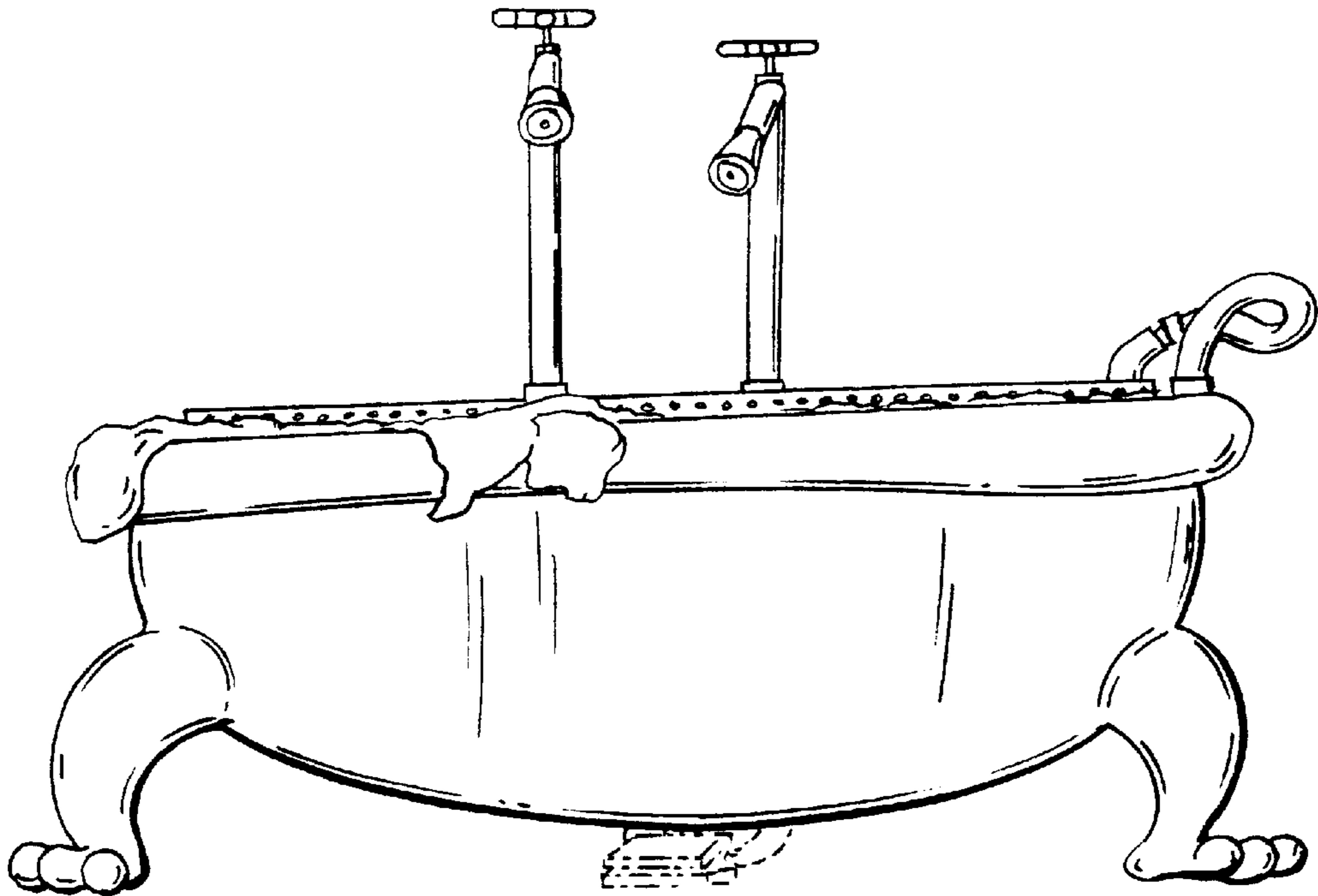

FIG. 3

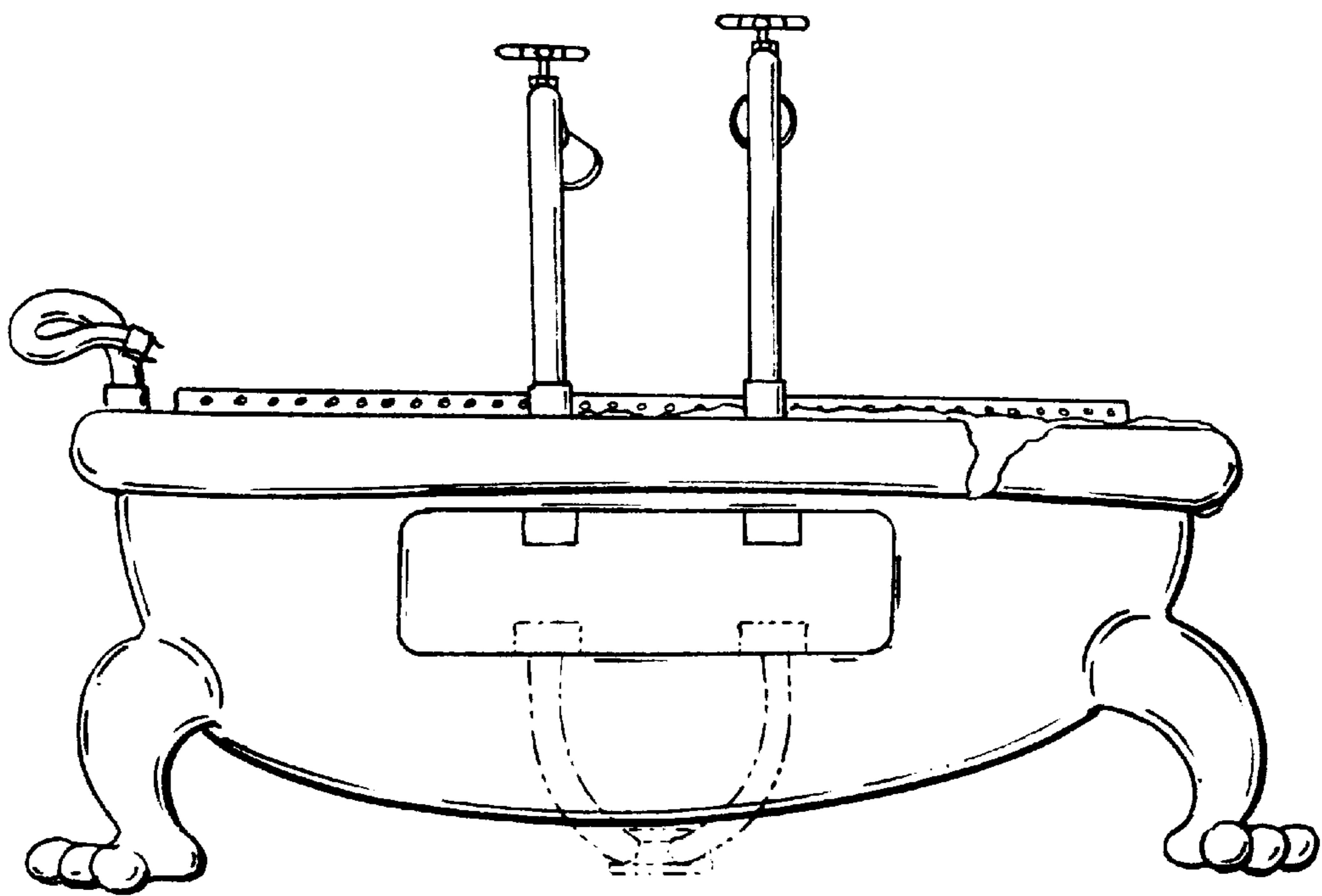

FIG. 4

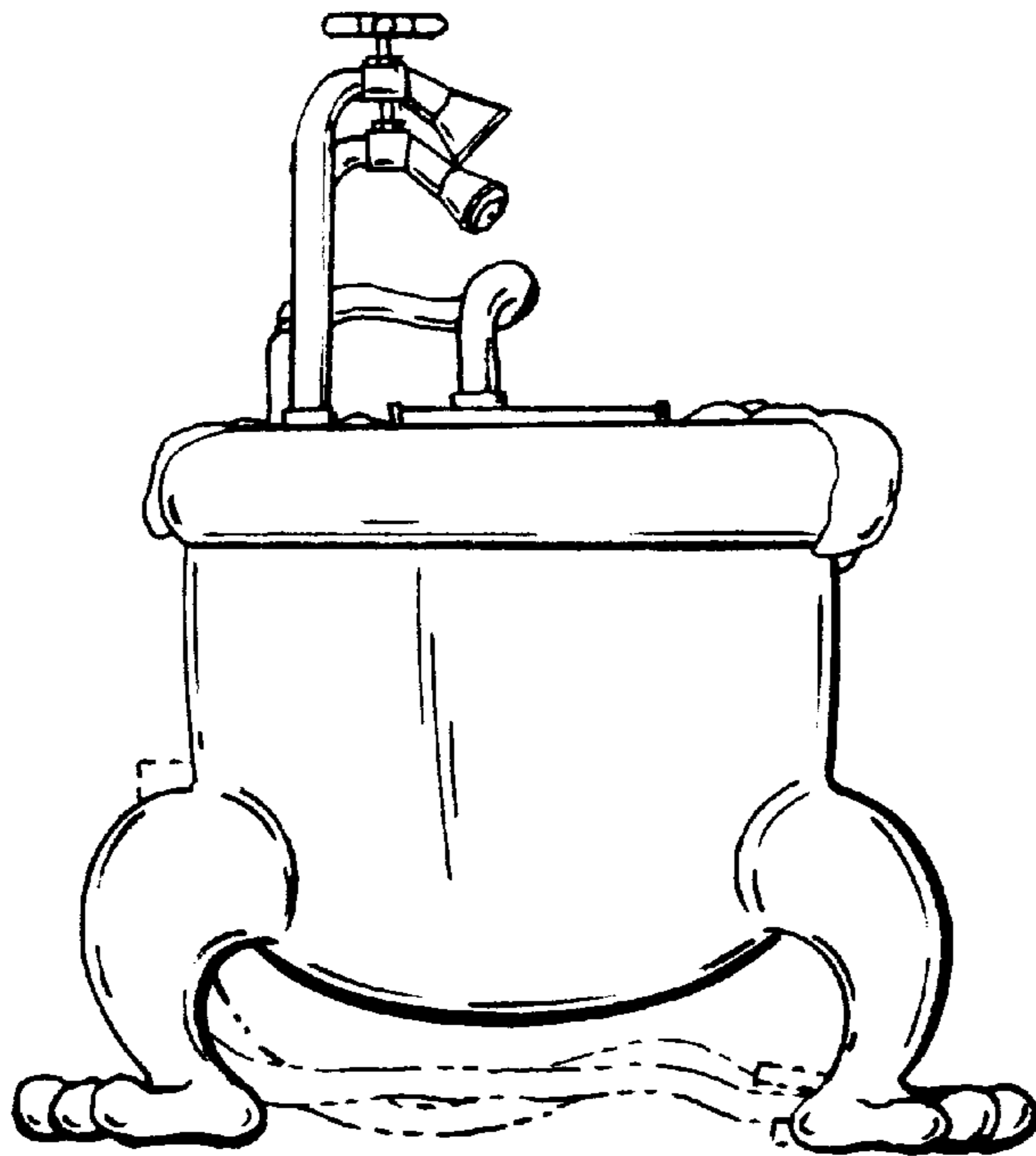

FIG. 5

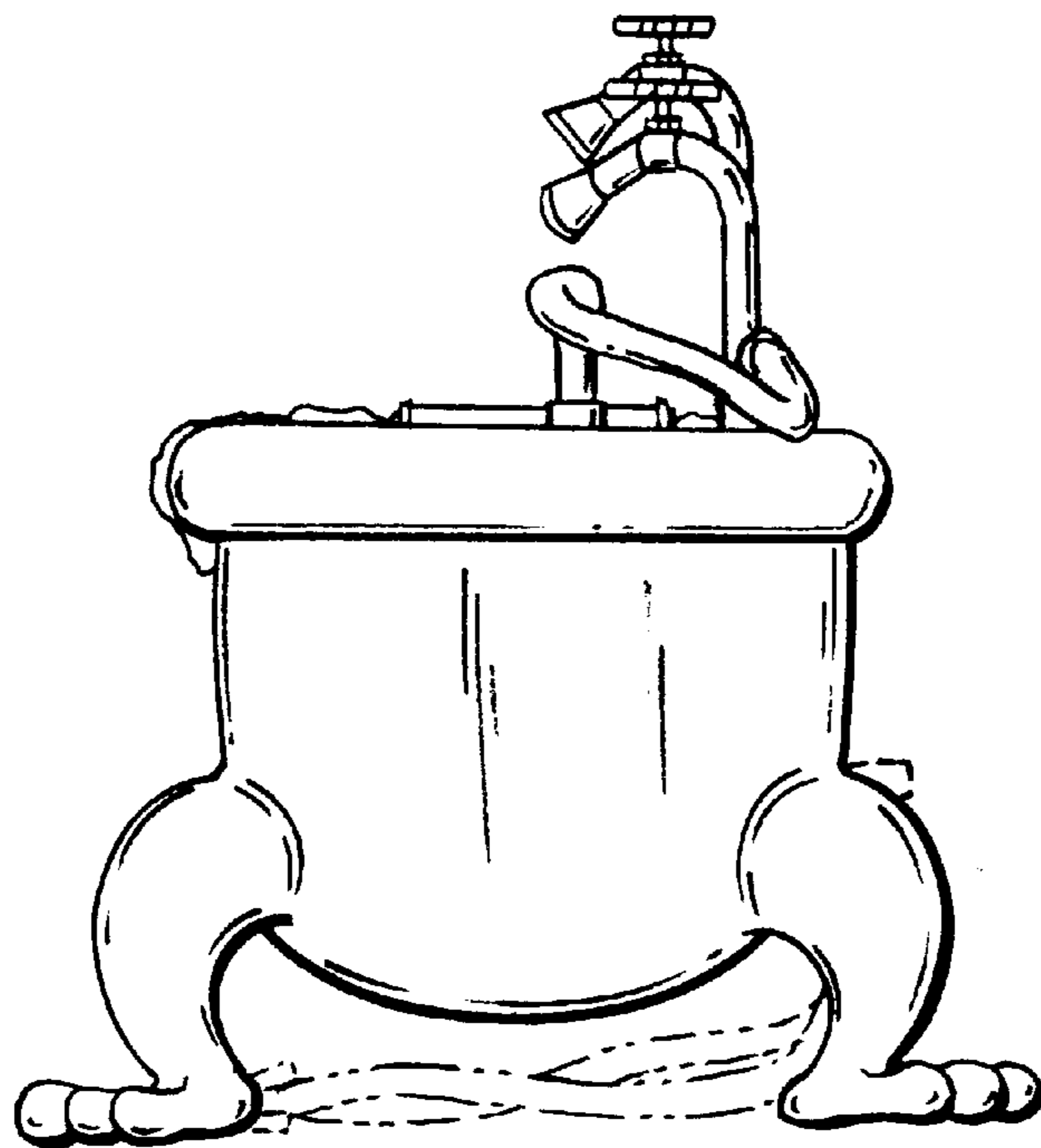

FIG. 6