



US00D413238S

United States Patent [19] Vasudeva

[11] **Patent Number: Des. 413,238**

[45] **Date of Patent: ** Aug. 31, 1999**

[54] **STRIKING TOOL**

[75] Inventor: **Kailash C. Vasudeva**, Waterloo, Canada

[73] Assignee: **Maxtech Manufacturing Inc.**, Waterloo, Canada

[**] Term: **14 Years**

[21] Appl. No.: **29/090,275**

[22] Filed: **Jul. 6, 1998**

[51] **LOC (6) Cl.** **08-03**

[52] **U.S. Cl.** **D8/47**

[58] **Field of Search** D8/14, 107, DIG. 7, D8/47; 30/366, 167, 295; 16/110 R, 116 R

[56] **References Cited**

U.S. PATENT DOCUMENTS

D. 46,785	12/1914	Bardwell	D8/47
D. 58,502	7/1921	Peck	D8/47
D. 127,284	5/1941	Shortell	D8/47
D. 354,663	1/1995	Clark et al.	D8/47
5,730,231	3/1998	Racodon	16/116 R
5,848,453	12/1998	Racodon	30/295

Primary Examiner—Alan P. Douglas

Assistant Examiner—Reid Hecker

Attorney, Agent, or Firm—R. Craig Armstrong

[57] **CLAIM**

The ornamental design for striking tool, as shown and described.

DESCRIPTION

FIG. 1 is a perspective view of the striking tool;

FIG. 2 is a side view of the striking tool, the side view at 180 degrees being identical;

FIG. 3 is a side view of the striking tool at 90 degrees to FIG. 2, the side view at 180 degrees to FIG. 3 being identical;

FIG. 4 is a top view of the striking tool;

FIG. 5 is a bottom view of the striking tool.

FIG. 6 is a side view of the a second embodiment of the striking tool, the side view at 180 degrees being identical; FIG. 7 is a side view of the second embodiment at 90 degrees to FIG. 6, the side view at 180 degrees to FIG. 7 begin identical;

FIG. 8 is a top view of the second embodiment;

FIG. 9 is a side view of a third embodiment of the striking tool, the side view at 180 degrees being identical;

FIG. 10 is a side view of the third embodiment at 90 degrees to FIG. 9, the side view at 180 degrees to FIG. 10 being identical;

FIG. 11 is a top view of the third embodiment;

FIG. 12 is a side view of a fourth embodiment of the striking tool, the side view at 180 degrees being identical;

FIG. 13 is a side view of the fourth embodiment at 90 degrees to FIG. 12, the side view at 180 degrees to FIG. 13 being identical;

FIG. 14 is a top view of the fourth embodiment;

FIG. 15 is a side view of a fifth embodiment of the striking tool, the side view at 180 degrees being identical;

FIG. 16 is a side view of the fifth embodiment at 90 degrees to FIG. 15, the side view at 180 degrees to FIG. 16 being identical;

FIG. 17 is a top view of the fifth embodiment;

FIG. 18 is a side view of a sixth embodiment of the striking tool, the side view at 180 degrees being identical;

FIG. 19 is a side view of the sixth embodiment at 90 degrees to FIG. 18, the side view at 180 degrees to FIG. 19 being identical; and,

FIG. 20 is a top view of the sixth embodiment.

The bottom of embodiments 2, 3, and 4 is the same as that in the first embodiment shown in FIG. 5, and the bottom of embodiments 5 and 6 are the same as that shown in FIG. 5 except that the hexagonal shaped shaft is circular and square respectively.

1 Claim, 6 Drawing Sheets

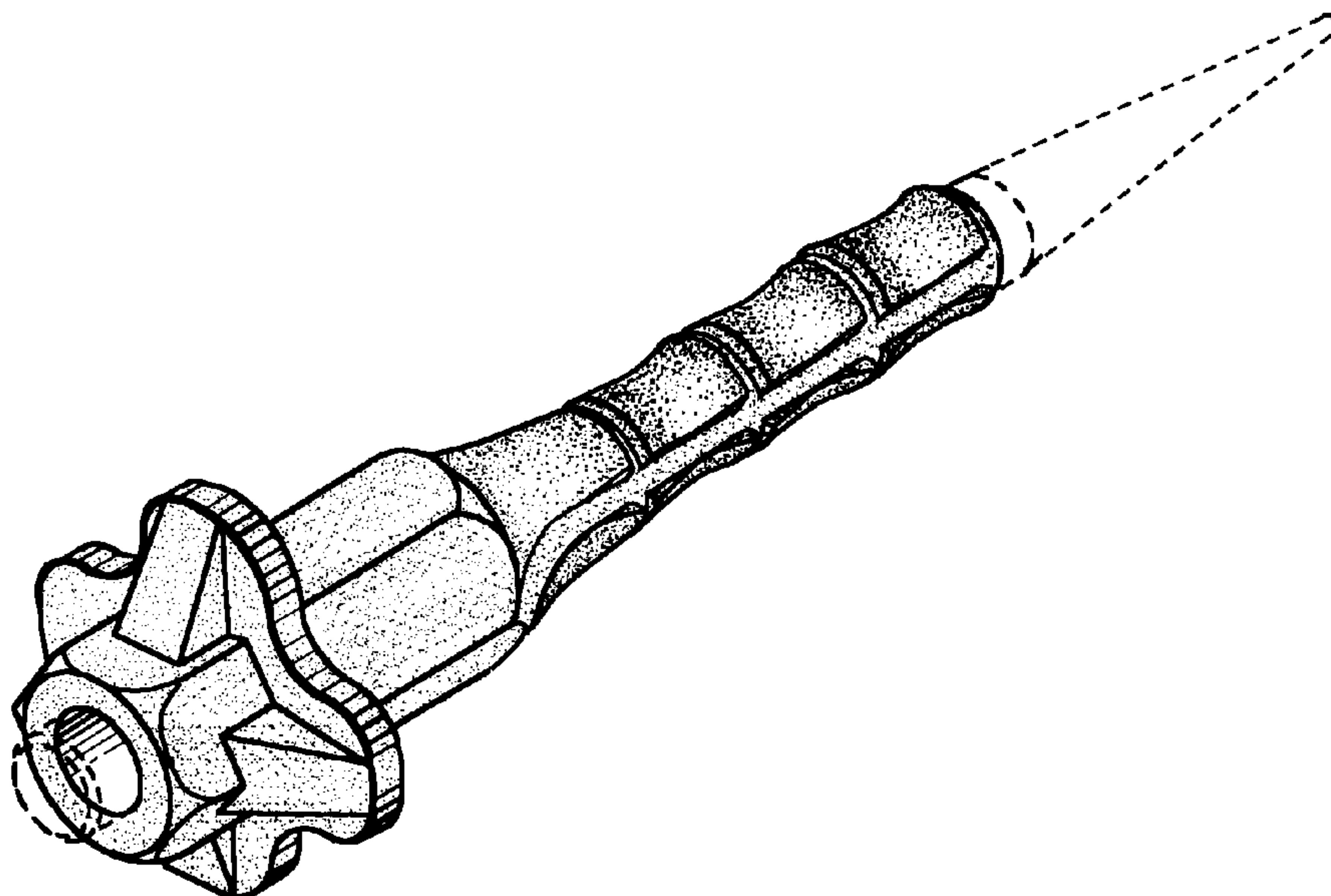

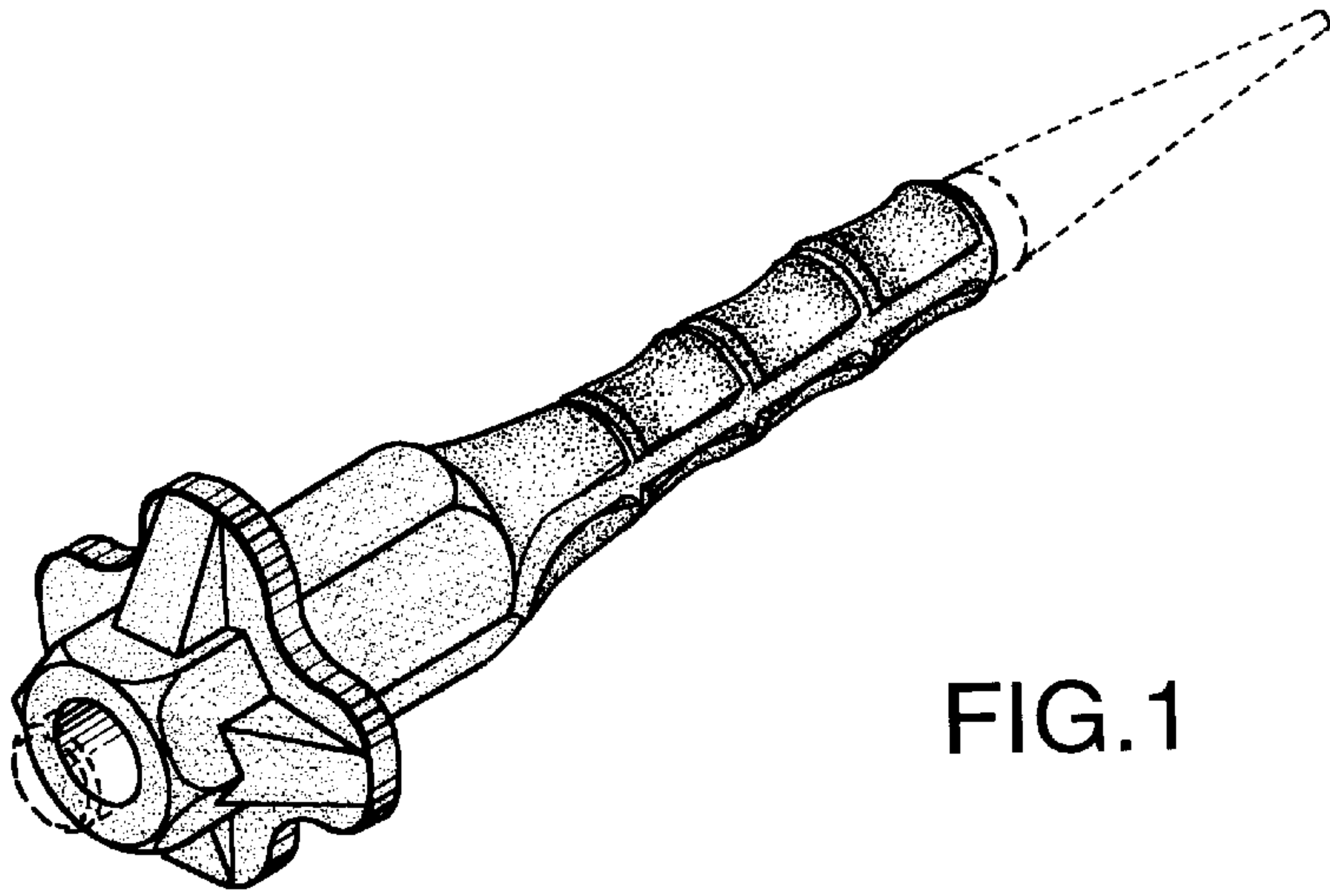

FIG. 1

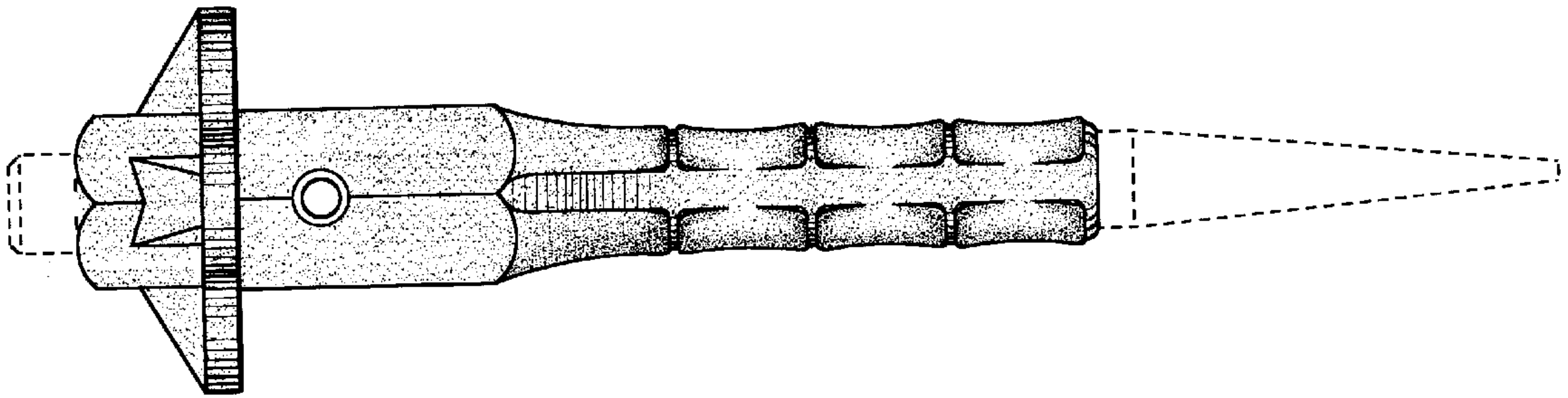

FIG. 2

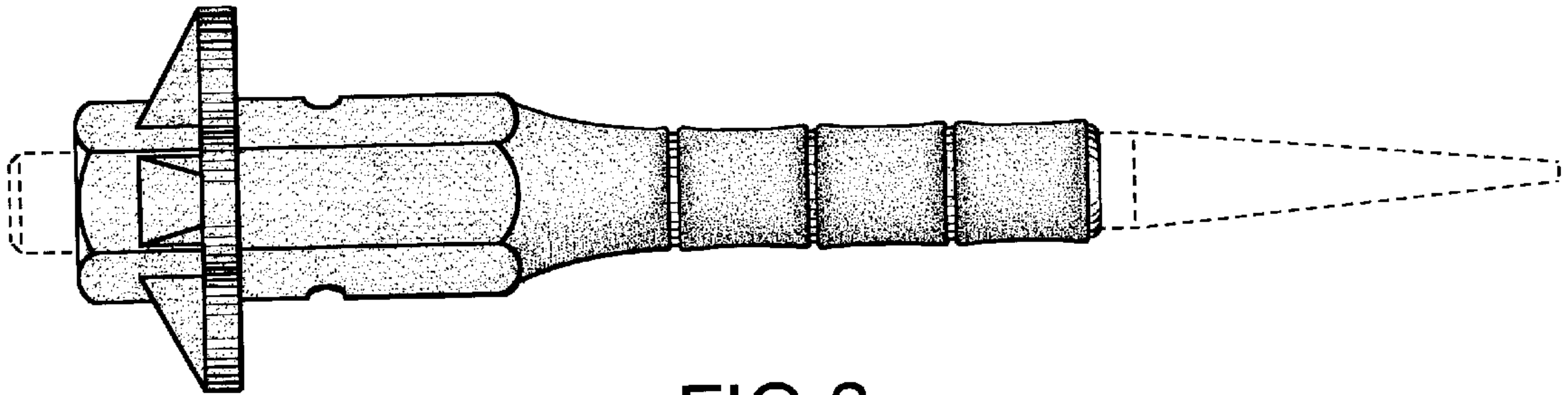

FIG. 3

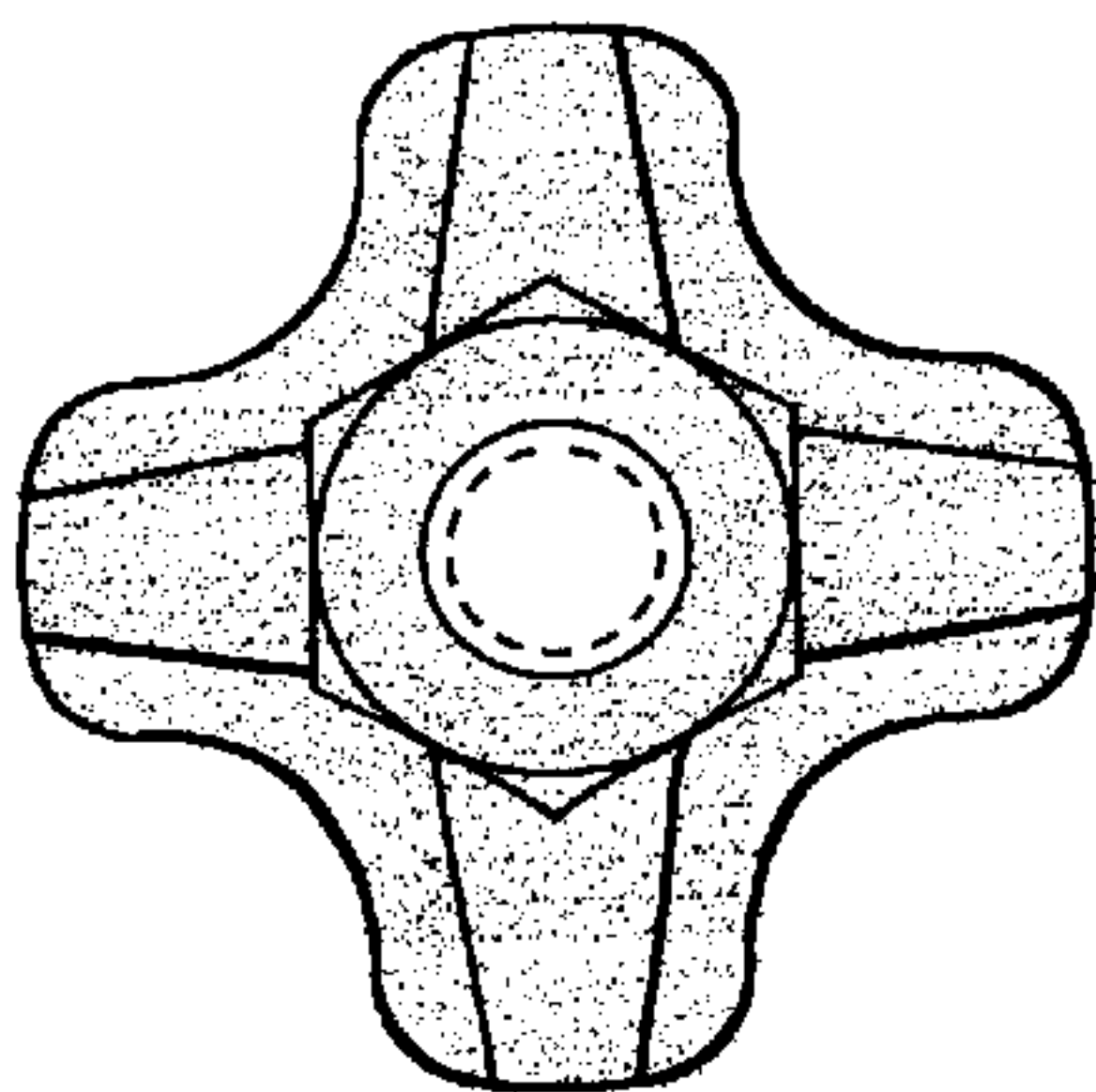

FIG. 4

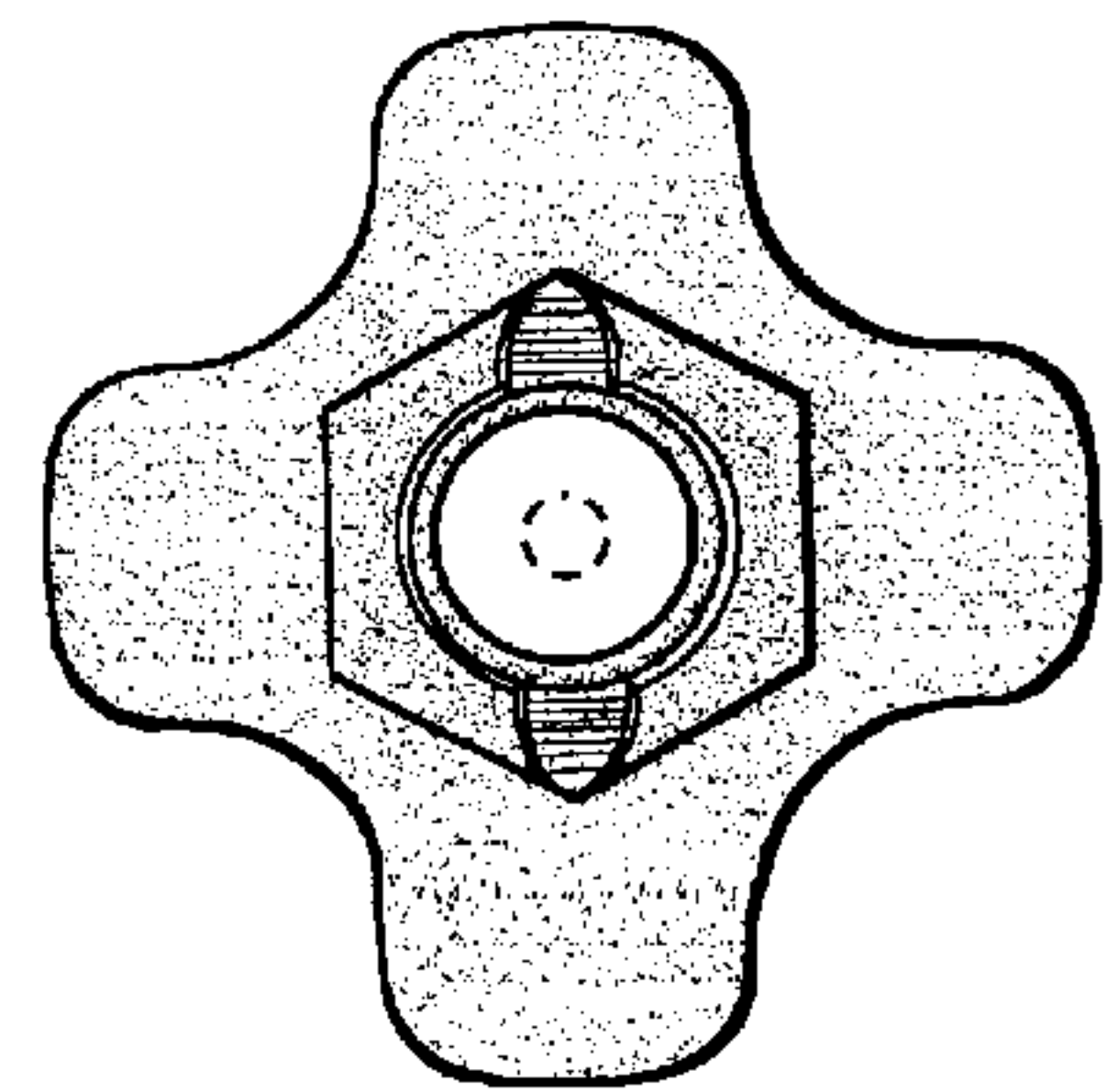

FIG. 5

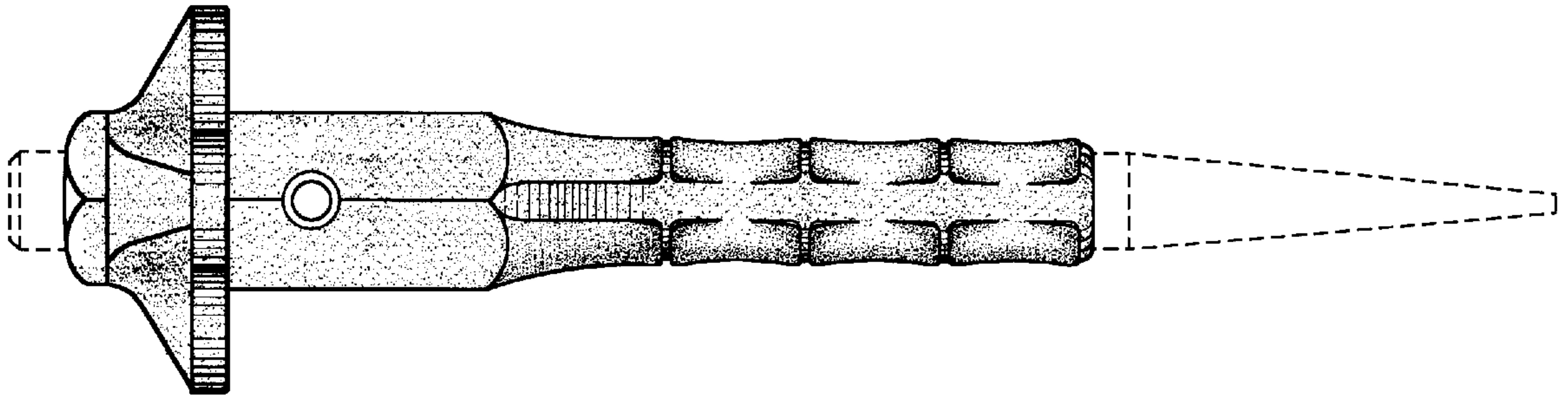

FIG. 6

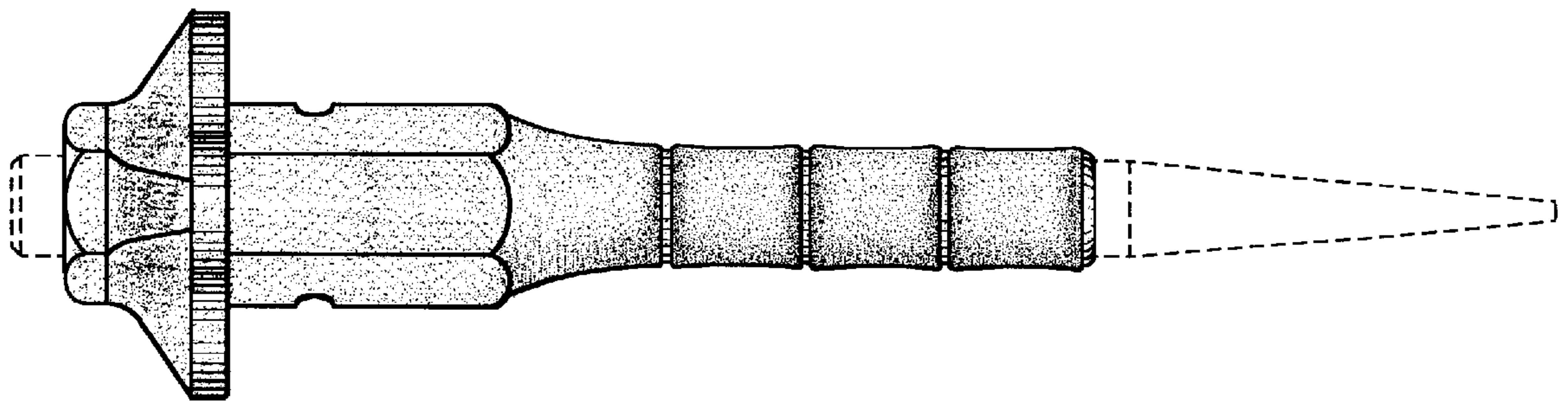

FIG. 7

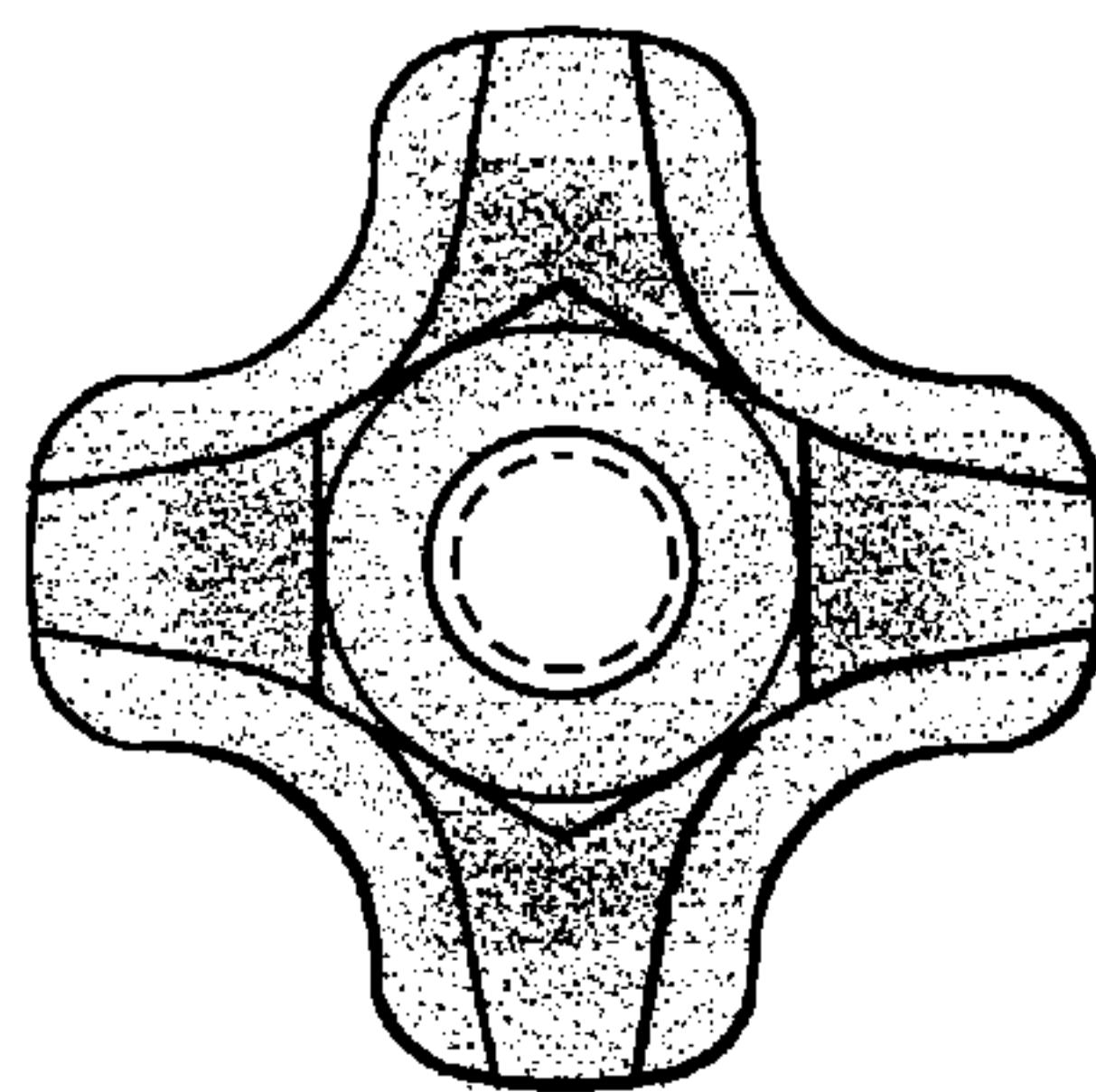

FIG. 8

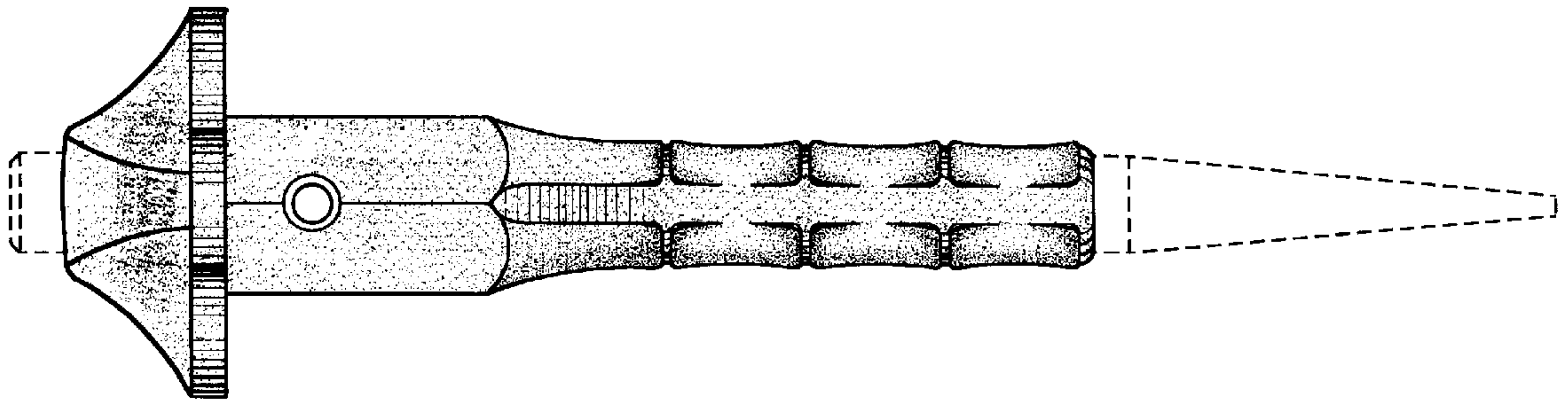

FIG. 9

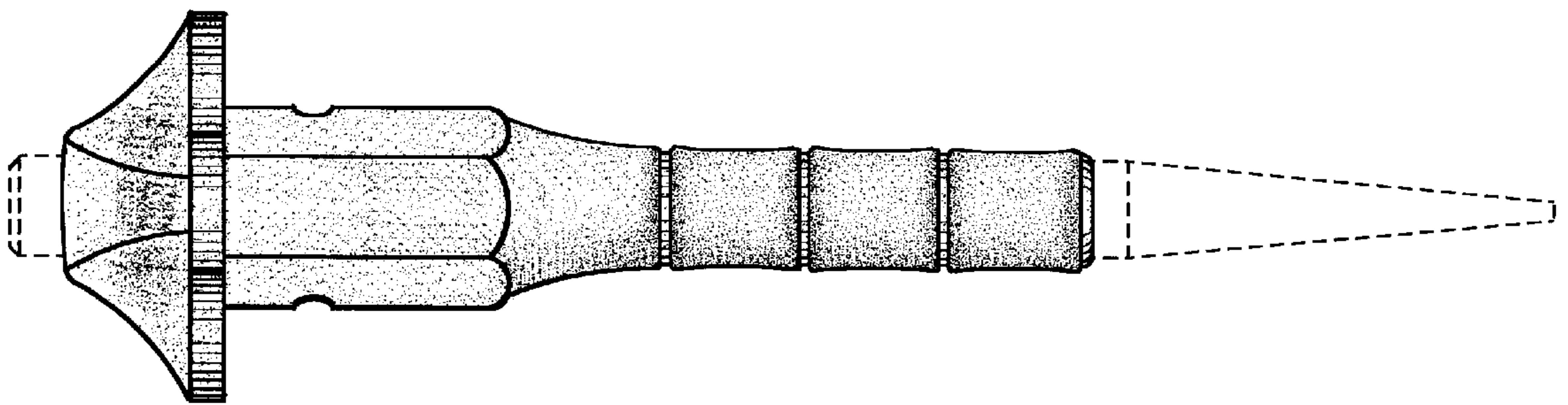

FIG. 10

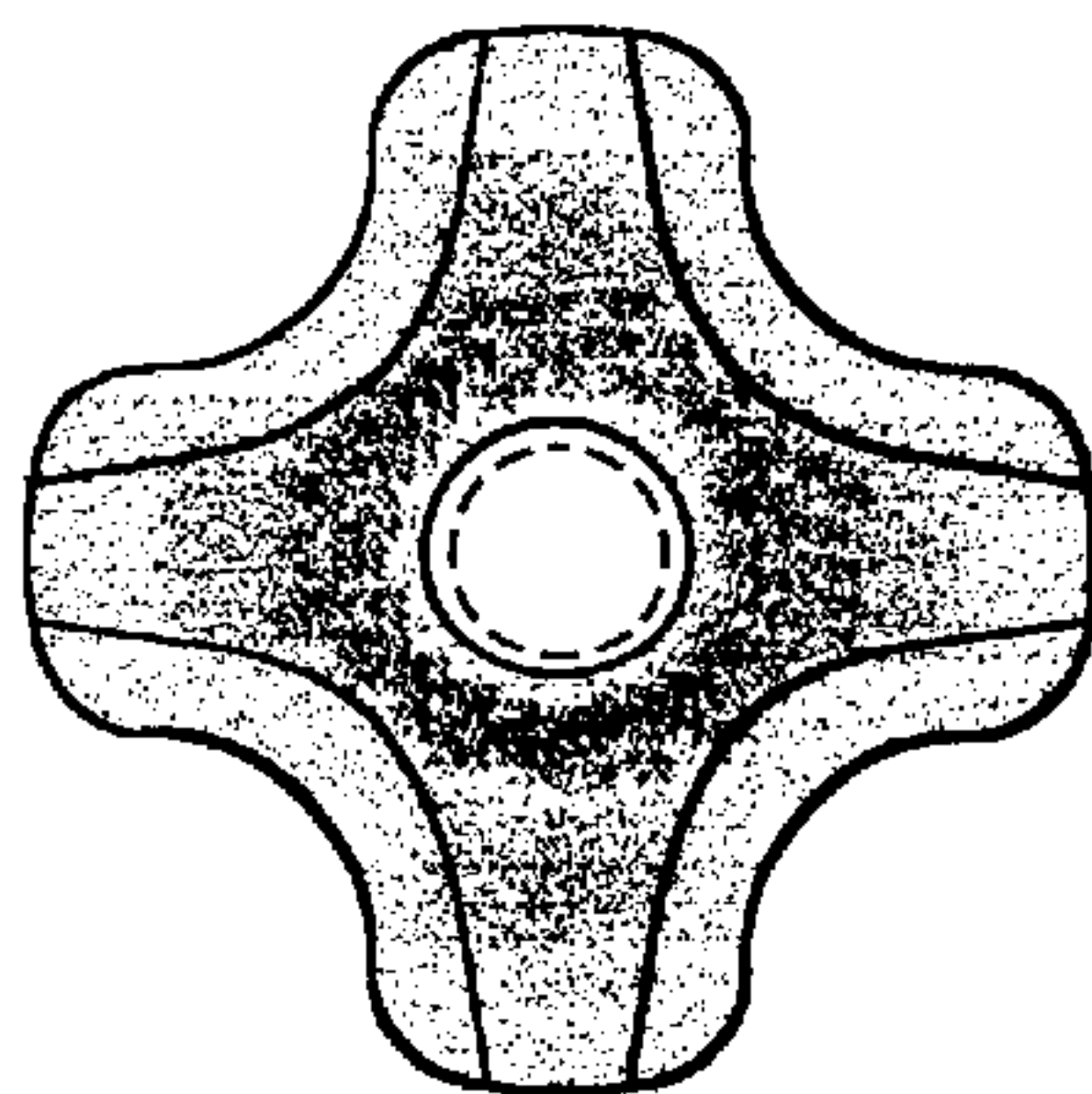

FIG. 11

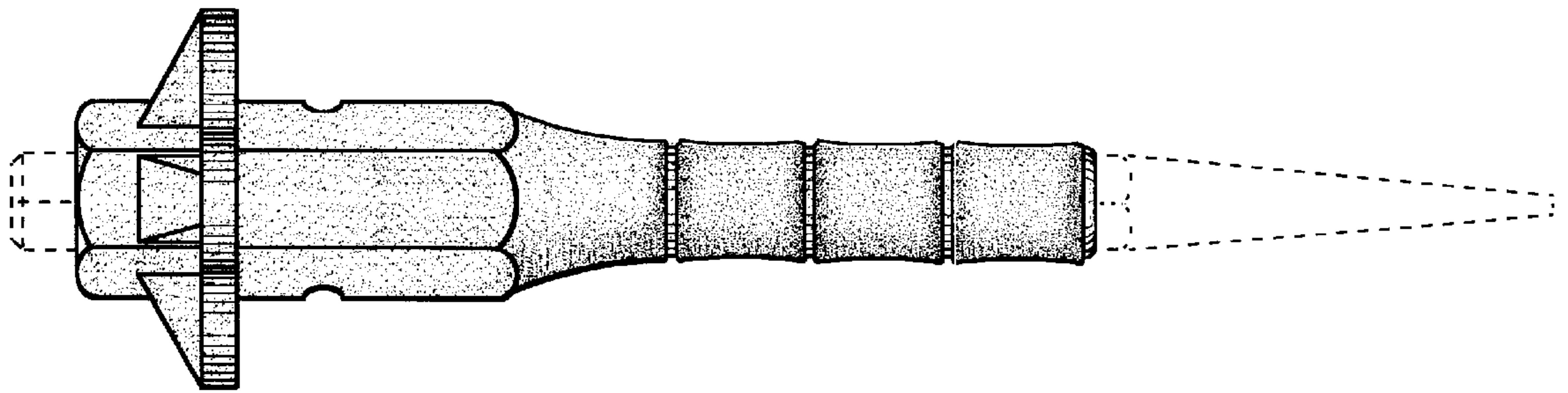

FIG. 12

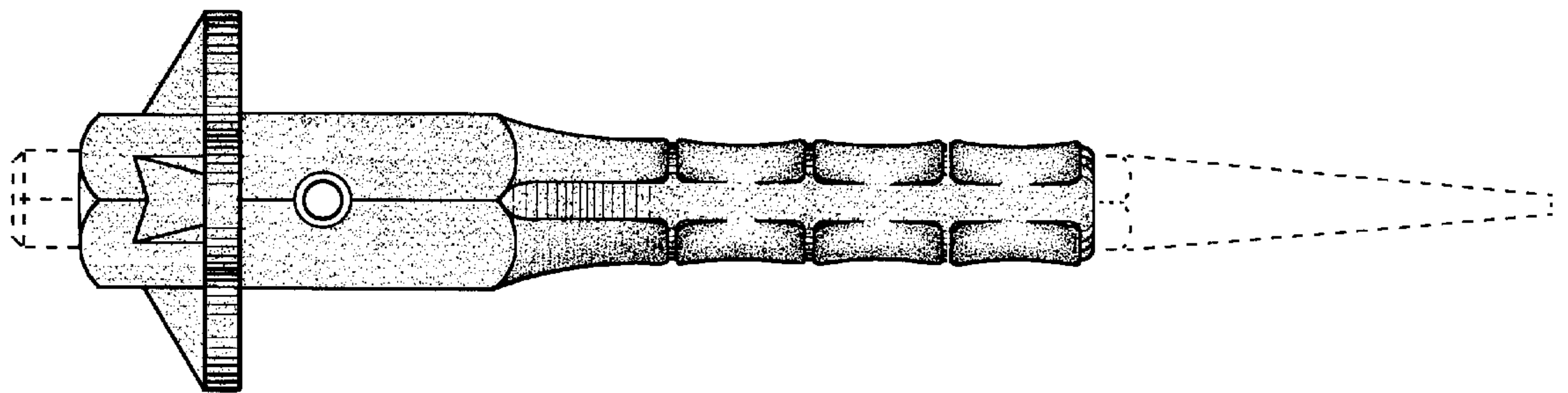

FIG. 13

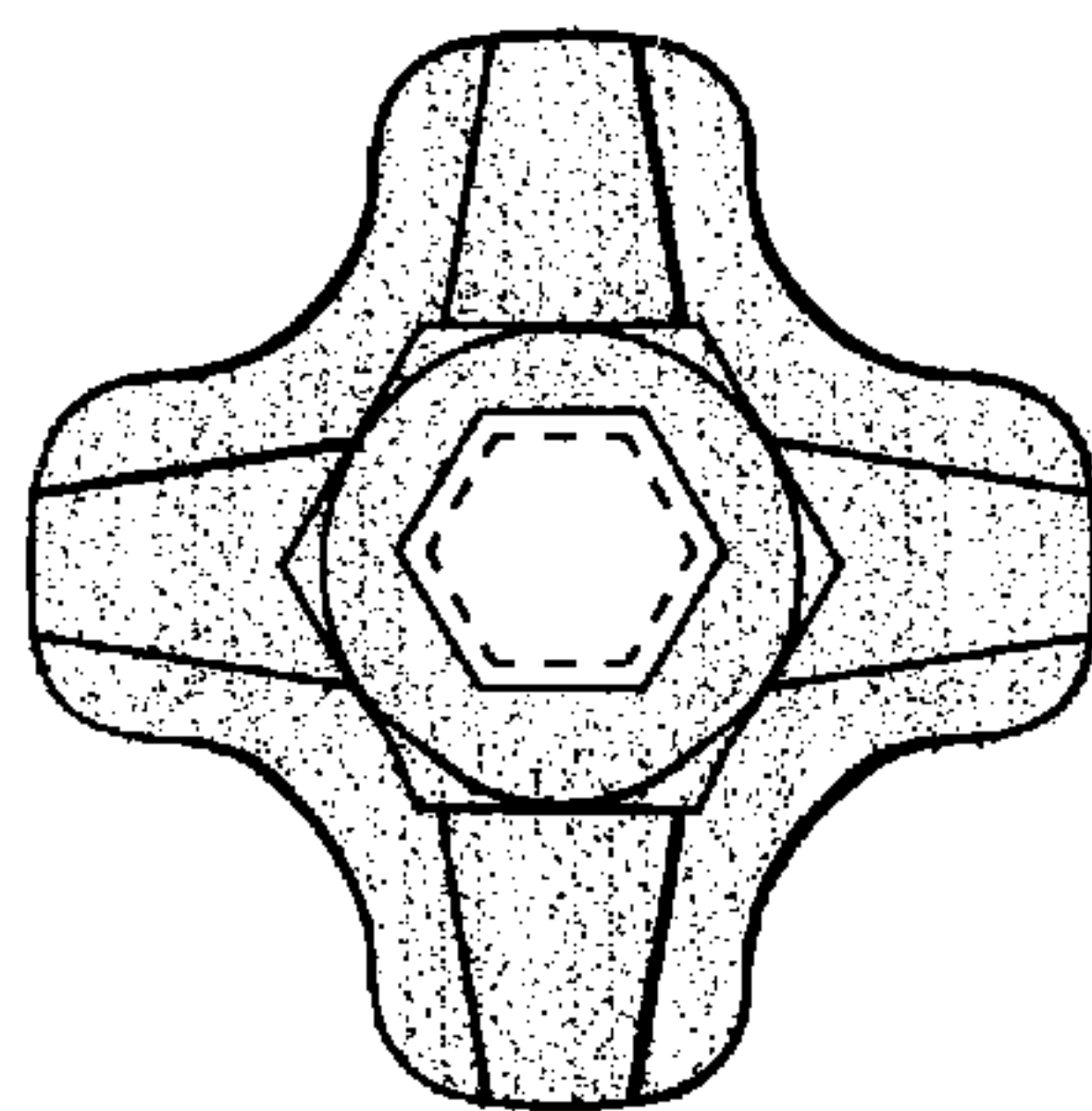

FIG. 14

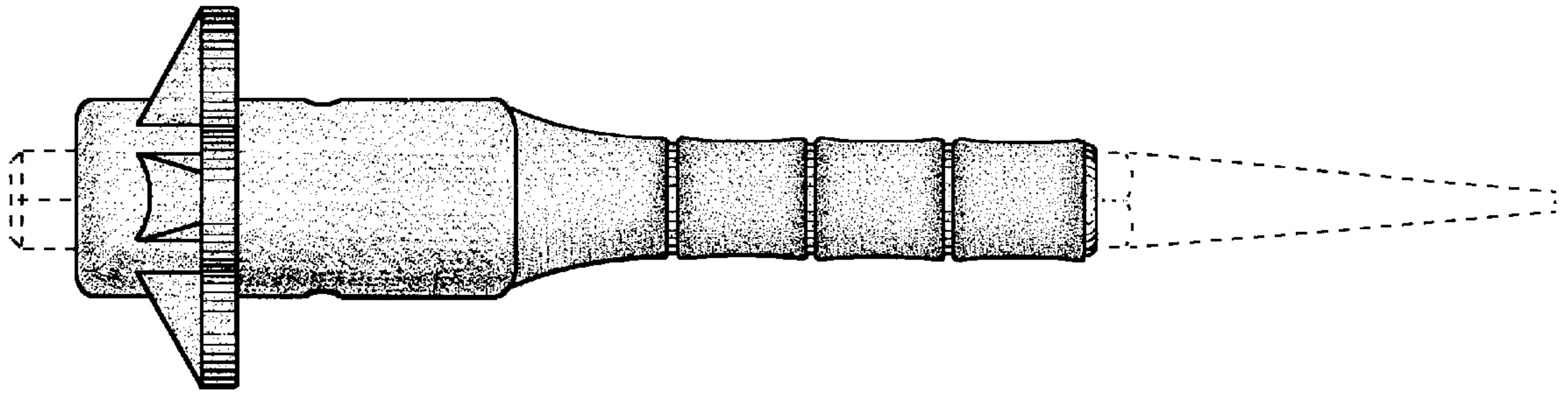

FIG. 15

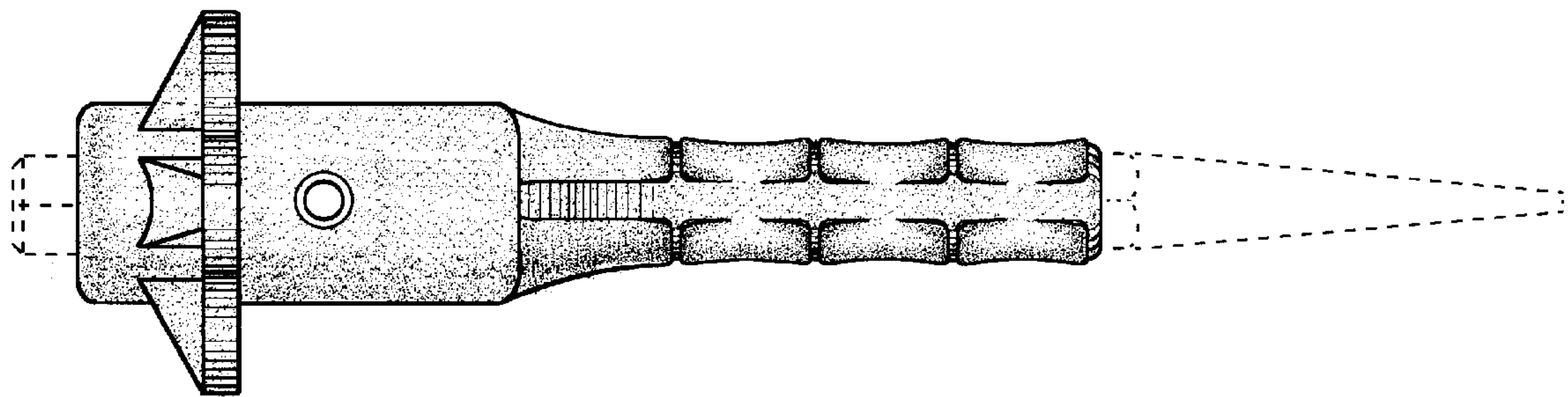

FIG. 16

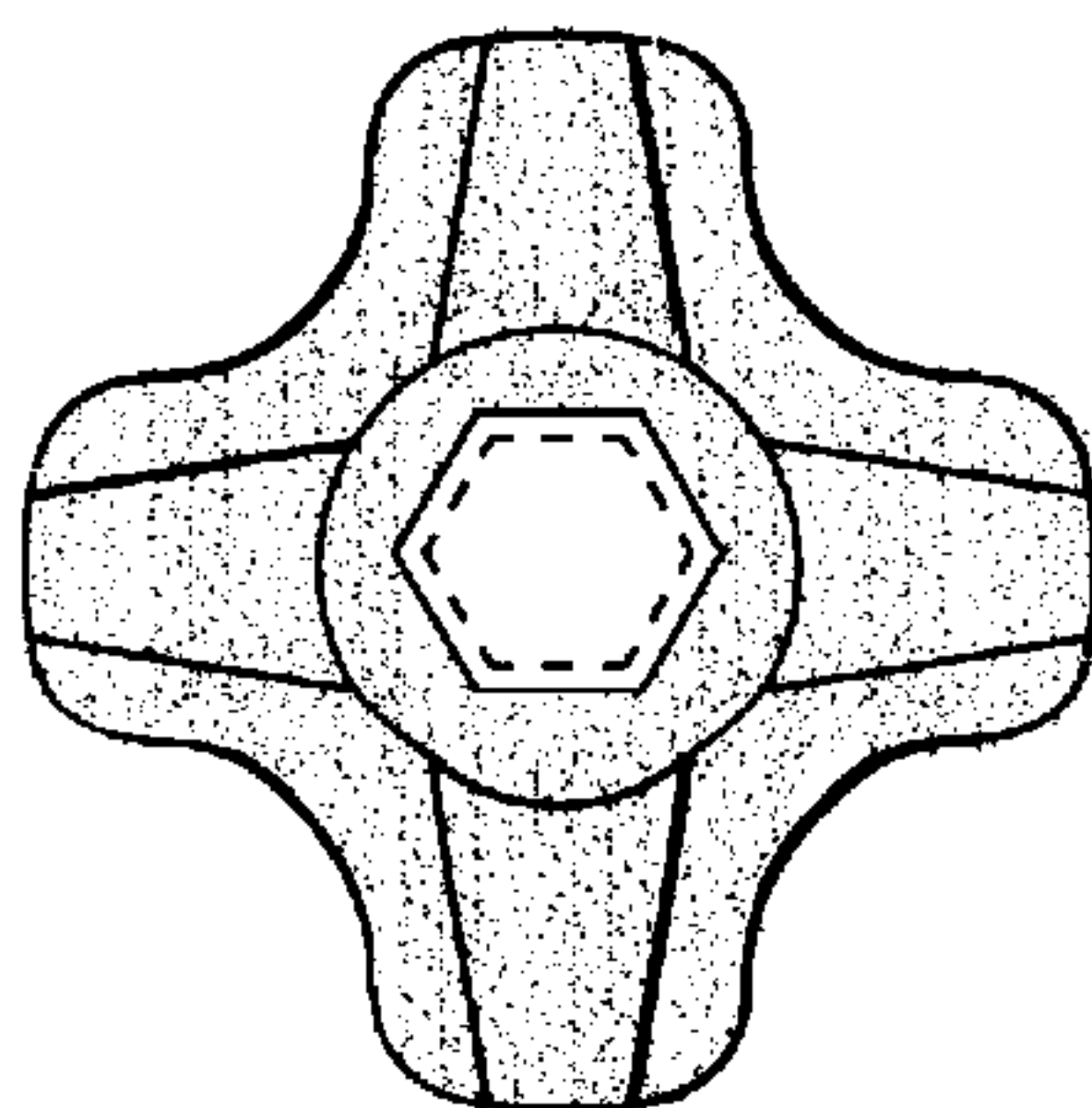

FIG. 17

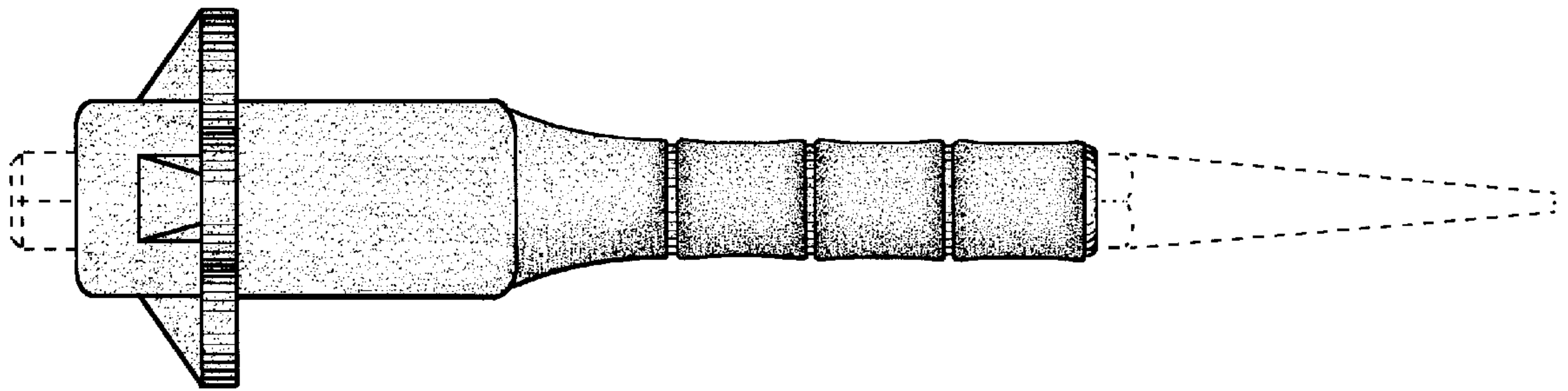

FIG.18

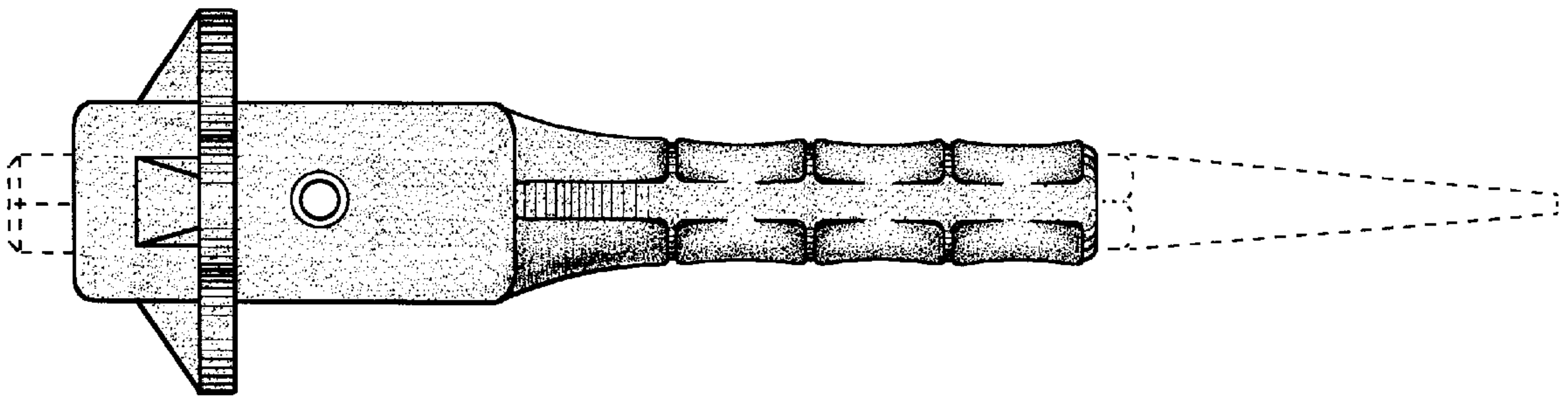

FIG.19

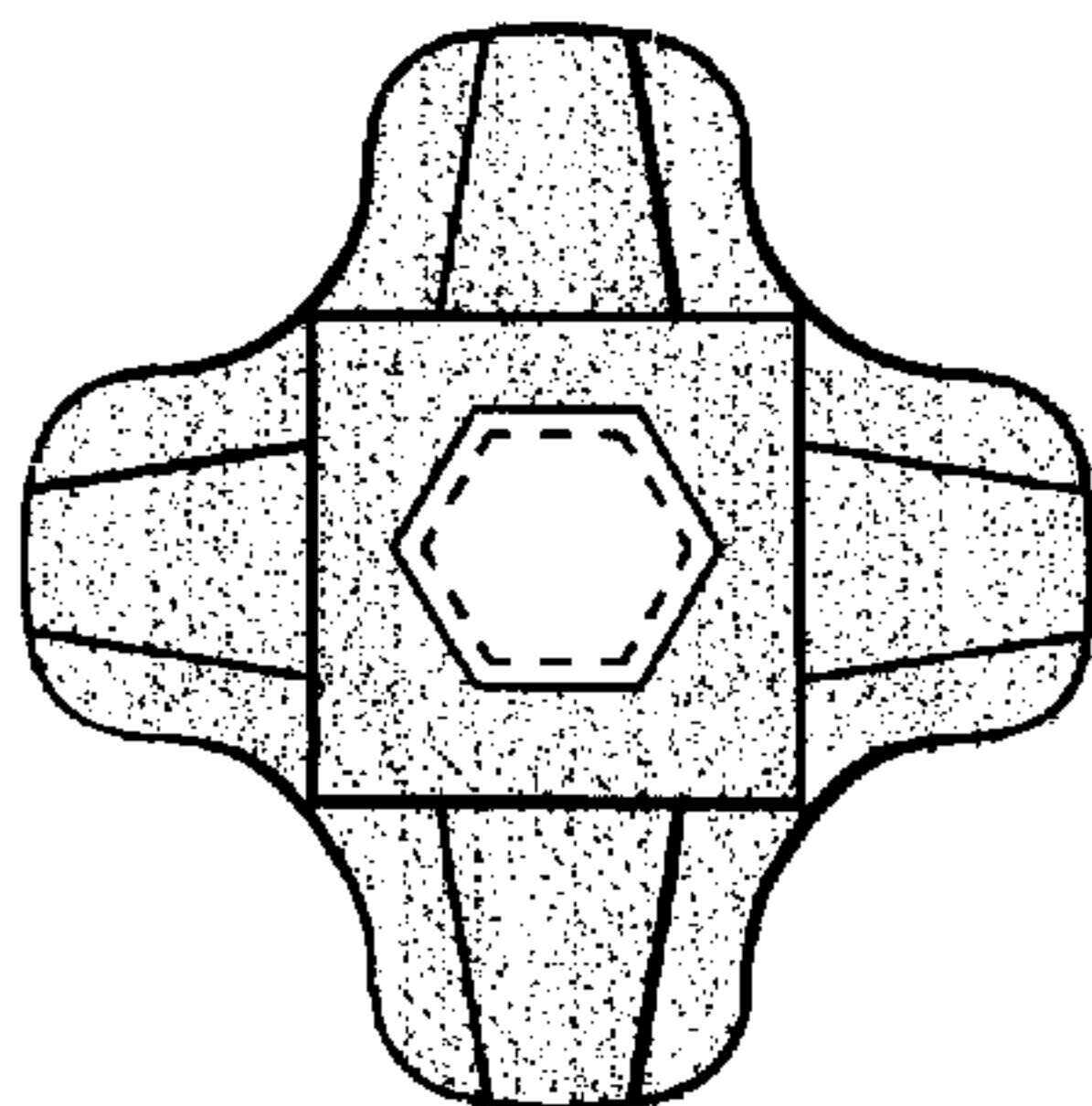

FIG.20