



US00D413219S

United States Patent [19]

Glenton Kerr

[11] Patent Number: Des. 413,219

[45] Date of Patent: ** Aug. 31, 1999

[54] SOAP DISH

[75] Inventor: **Helen Elizabeth Glenton Kerr**,
Toronto, Canada

[73] Assignee: **Umbra Inc.**, Buffalo, N.Y.

[**] Term: **14 Years**

[21] Appl. No.: **29/077,117**

[22] Filed: **Sep. 22, 1997**

[51] LOC (6) Cl. **07-07**

[52] U.S. Cl. **D6/536**

[58] Field of Search D6/536, 540; 211/13.1,
211/82, 88, 71, 126.1; 248/309.1; 206/77.1

[56] **References Cited**

U.S. PATENT DOCUMENTS

- D. 302,832 8/1989 King D6/536
- D. 305,671 1/1990 King D6/536
- D. 337,682 7/1993 Crook et al. D6/536

- D. 356,914 4/1995 Cecula D6/536
- D. 367,986 3/1996 Haley et al. D6/536
- D. 394,773 6/1998 Patel D6/536

Primary Examiner—Brian N. Vinson
Attorney, Agent, or Firm—Ostrolenk, Faber, Gerb & Soffen, LLP

[57] **CLAIM**

The ornamental design for a soap dish, as shown and described.

DESCRIPTION

FIG. 1 is a top view showing the new design;
FIG. 2 is a front view thereof, the back view being a mirror image thereof;
FIG. 3 is a bottom view thereof;
FIG. 4 is a right side view thereof, the left side view being a mirror image thereof;
FIG. 5 is a section view along 5—5 of FIG. 1; and,
FIG. 6 is a section view along 6—6 of FIG. 1.

1 Claim, 2 Drawing Sheets

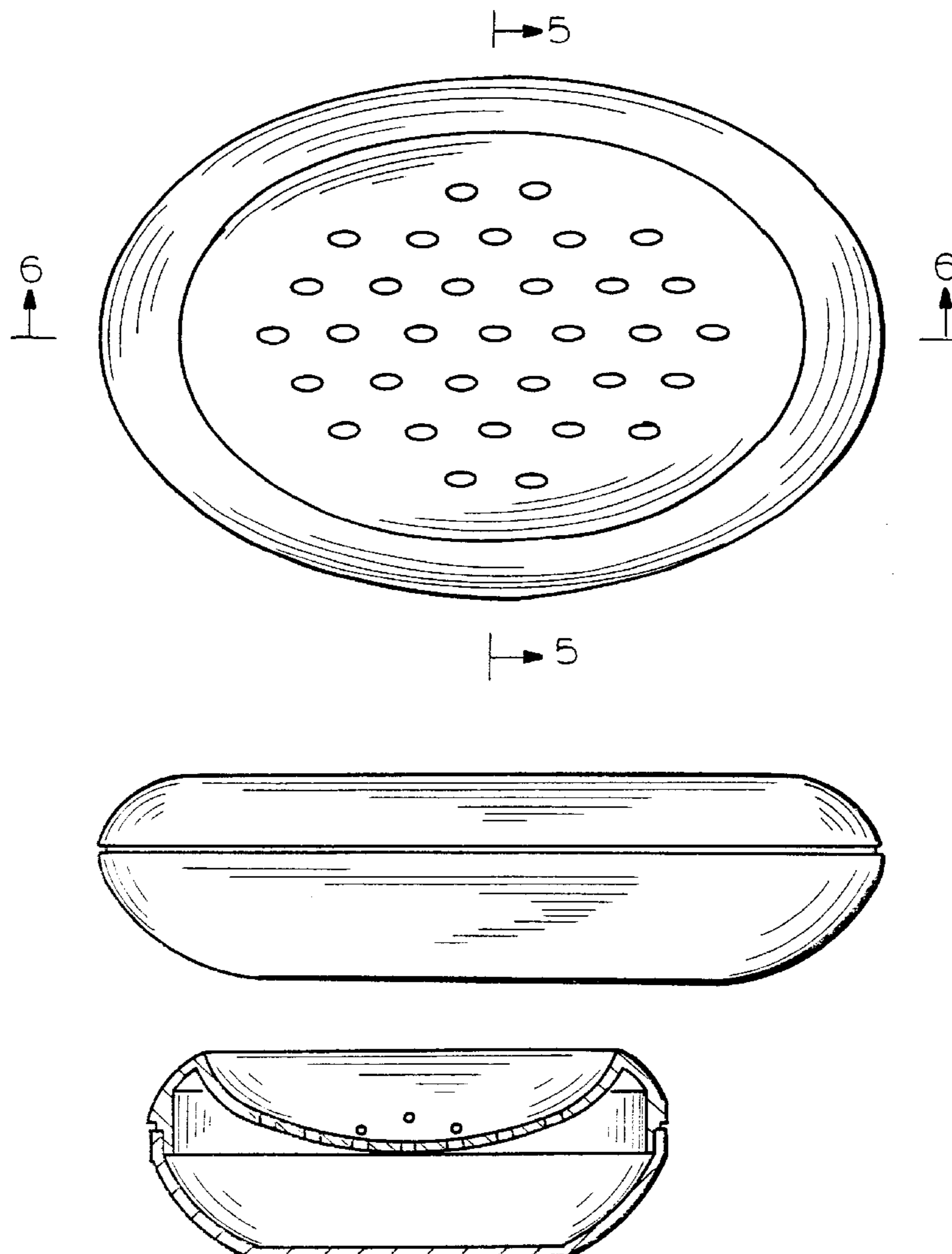

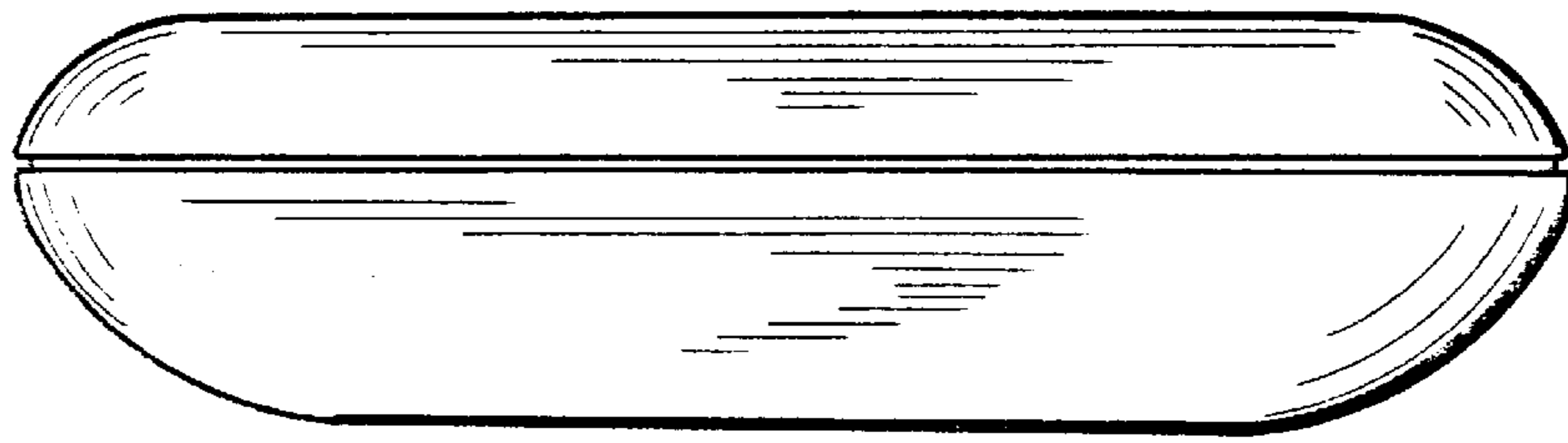
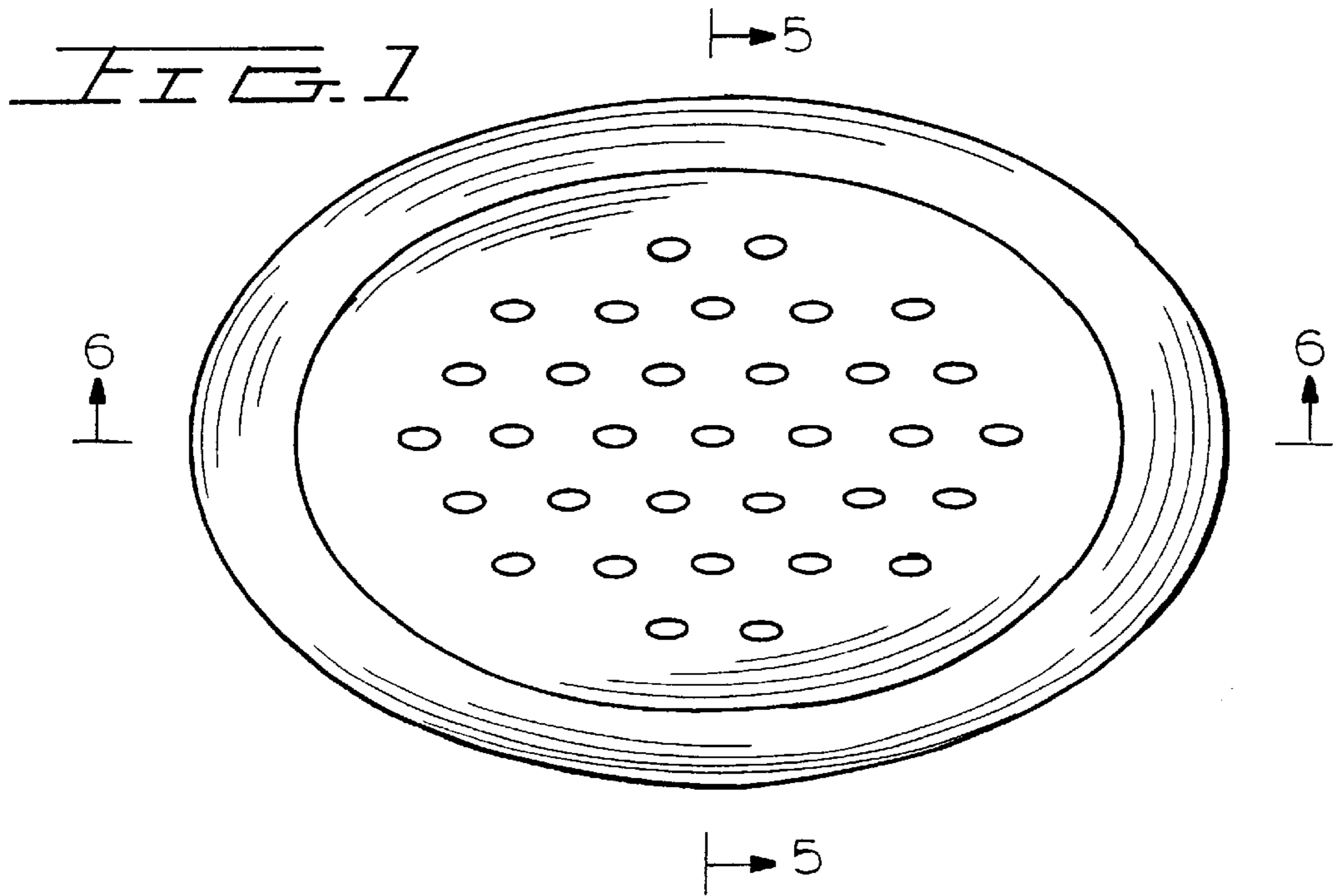

FIG. 2

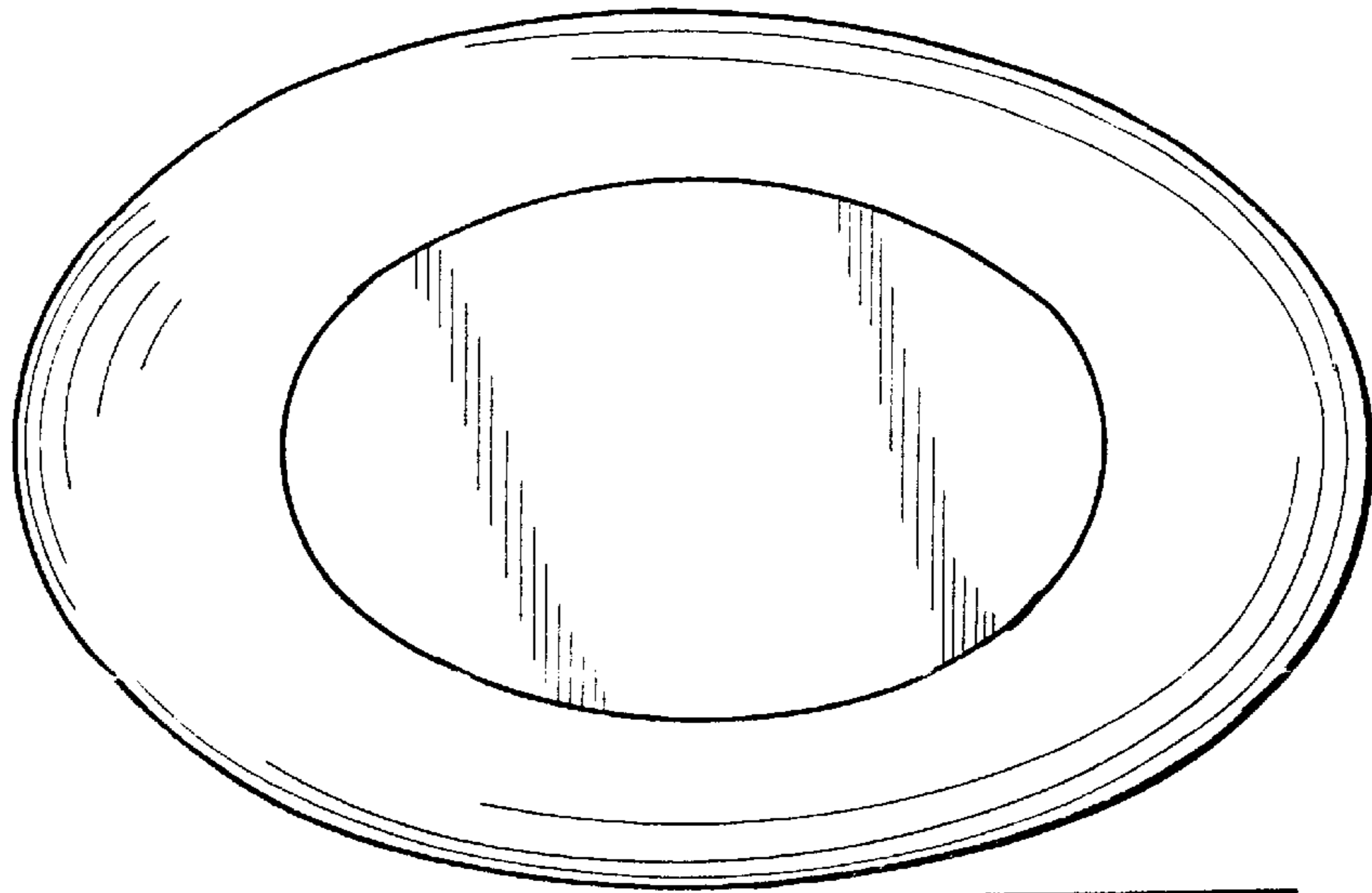

FIG. 3

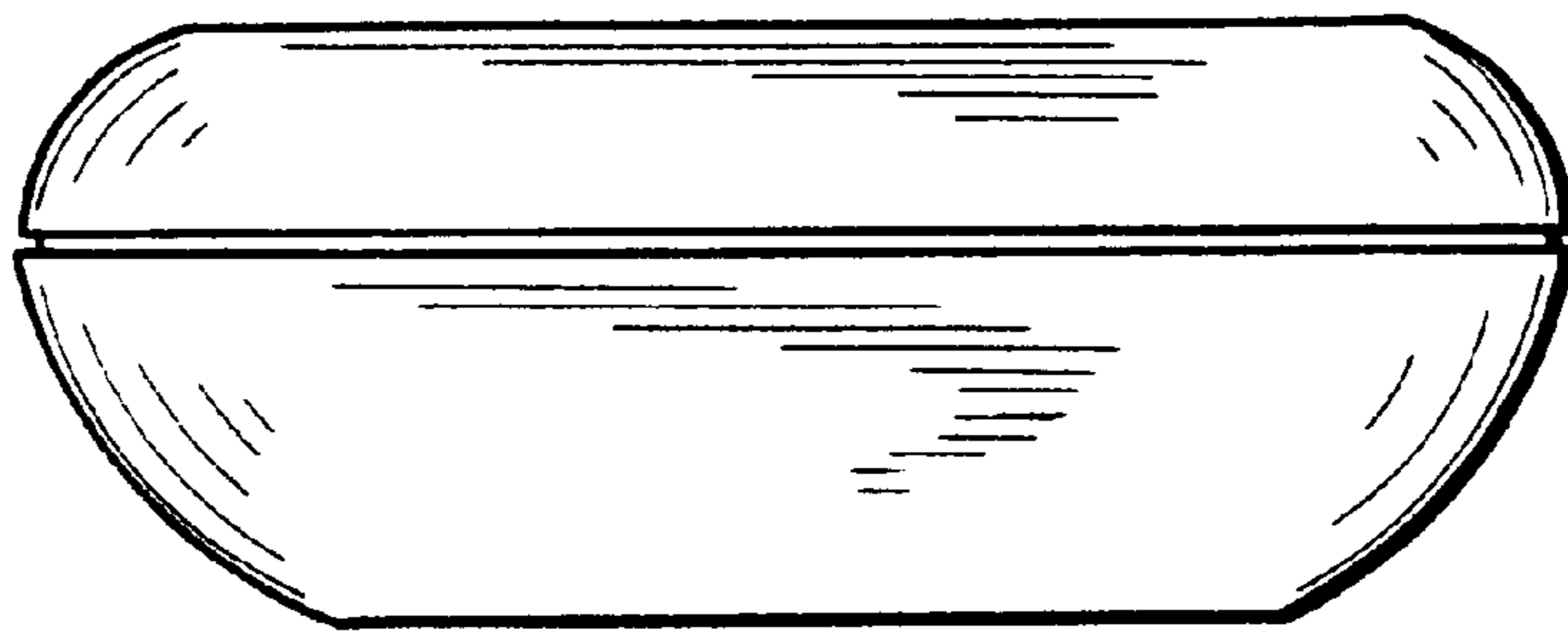

FIG. 4

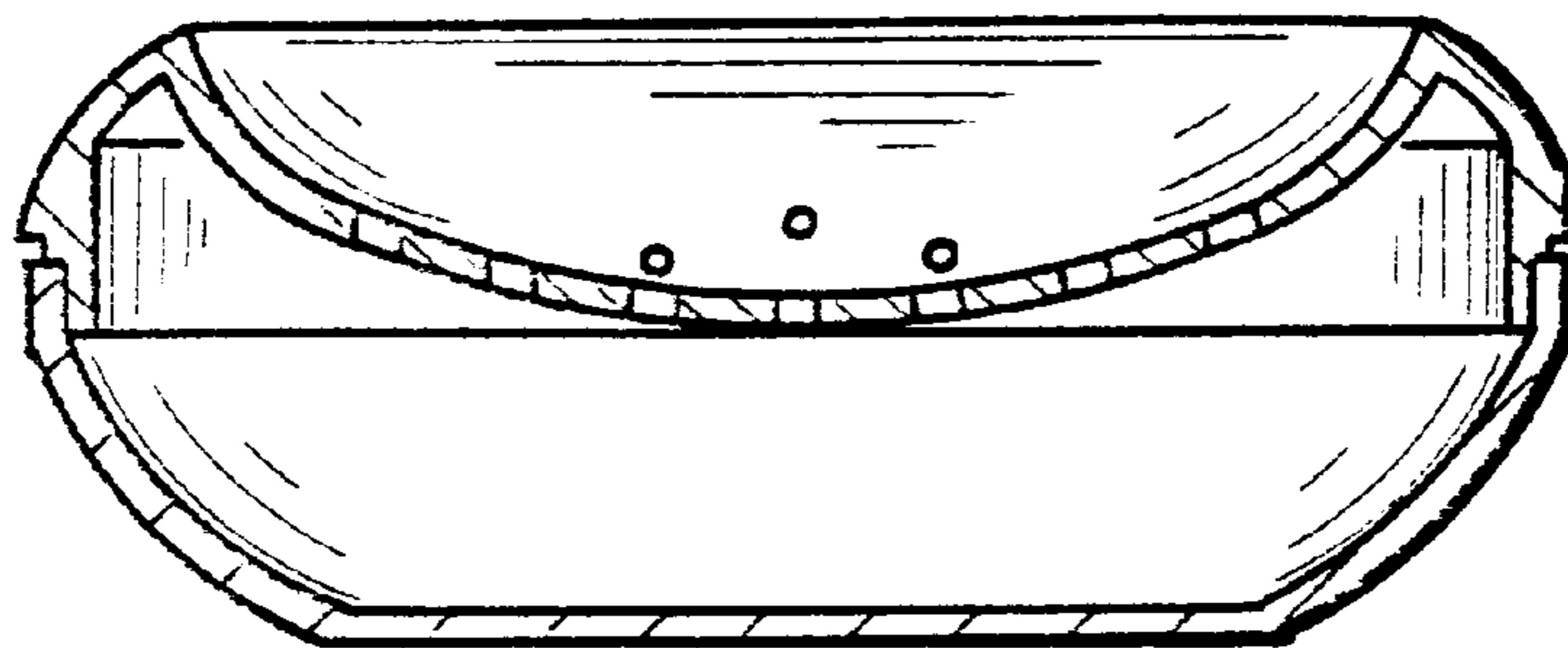

FIG. 5

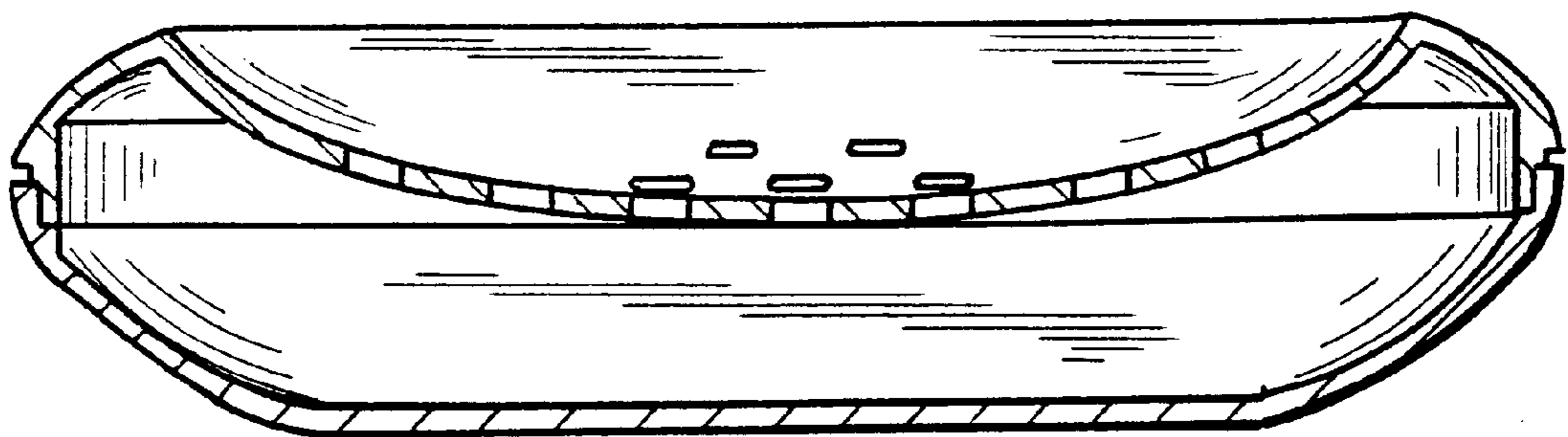

FIG. 6