



US00D413215S

United States Patent [19]
Mei

[11] **Patent Number: Des. 413,215**

[45] **Date of Patent: ** Aug. 31, 1999**

[54] **CHAIR ARMREST**

[76] Inventor: **Teng-Fu Mei**, P.O. Box 63-247,
Taichung, Taiwan

[**] Term: **14 Years**

[21] Appl. No.: **29/094,024**

[22] Filed: **Sep. 24, 1998**

[51] **LOC (6) Cl.** **06-06**

[52] **U.S. Cl.** **D6/501; D6/366**

[58] **Field of Search** D6/334, 364, 365,
D6/366, 367, 379, 500, 501, 502; 297/411.2

[56] **References Cited**

U.S. PATENT DOCUMENTS

D. 308,605	6/1990	Decker et al.	D6/366
D. 371,475	7/1996	Tedesco	D6/501
D. 388,258	12/1997	Ambasz	D6/366
D. 405,618	2/1999	Reutepohler et al.	D6/366

Primary Examiner—Gary D. Watson
Attorney, Agent, or Firm—Charles E. Baxley, Esq.

[57] **CLAIM**

The ornamental design for a chair armrest, as shown and described.

DESCRIPTION

FIG. 1 is a perspective view of a chair armrest showing my new design;

FIG. 2 is a front elevational view thereof;

FIG. 3 is a rear elevational view thereof;

FIG. 4 is a left elevational view thereof;

FIG. 5 is a right elevational view thereof;

FIG. 6 is a top plan view thereof; and,

FIG. 7 is a bottom plan view thereof.

FIGS. 2 through 7 have been shown on a reduced scale with respect to FIG. 1.

1 Claim, 4 Drawing Sheets

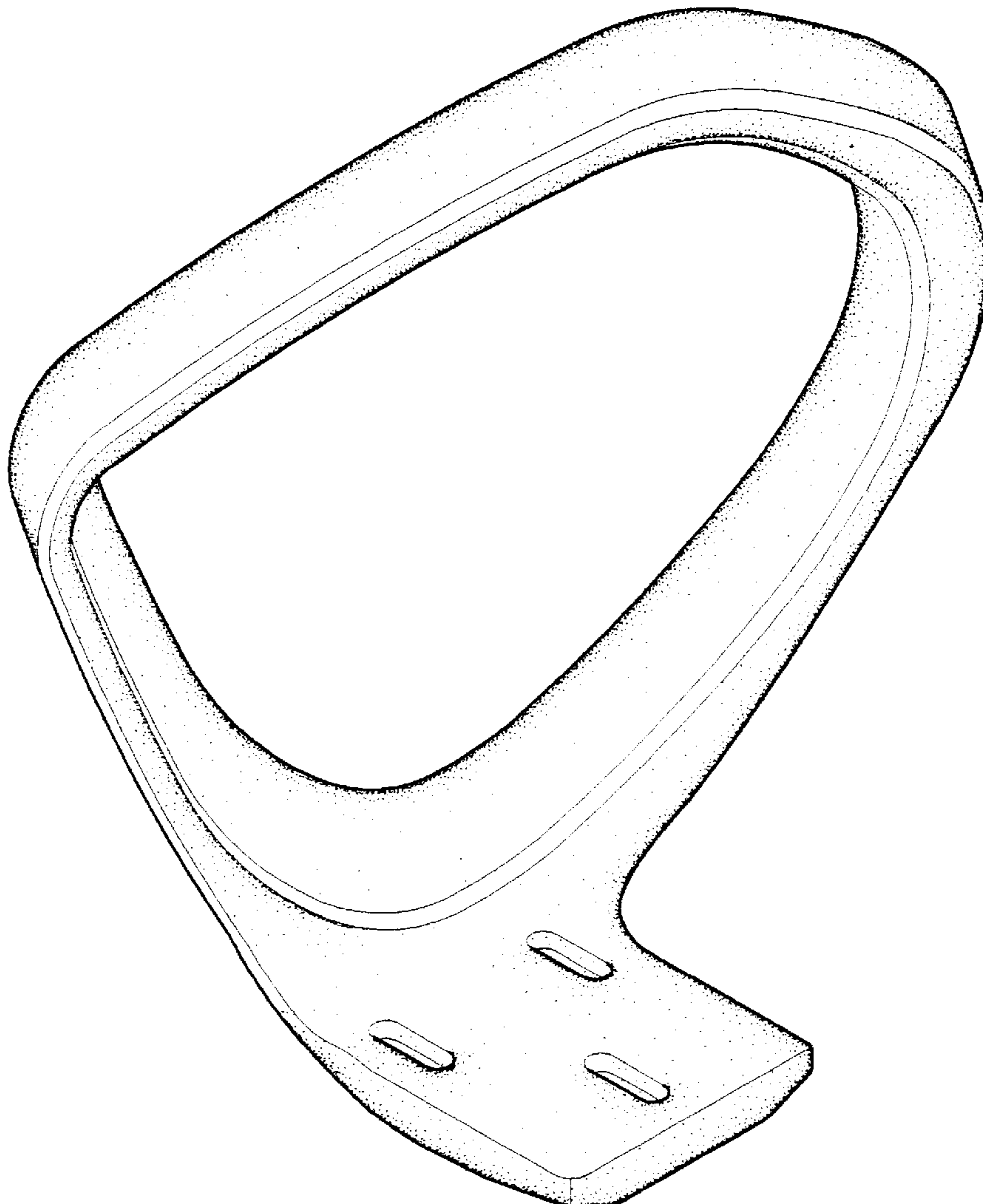

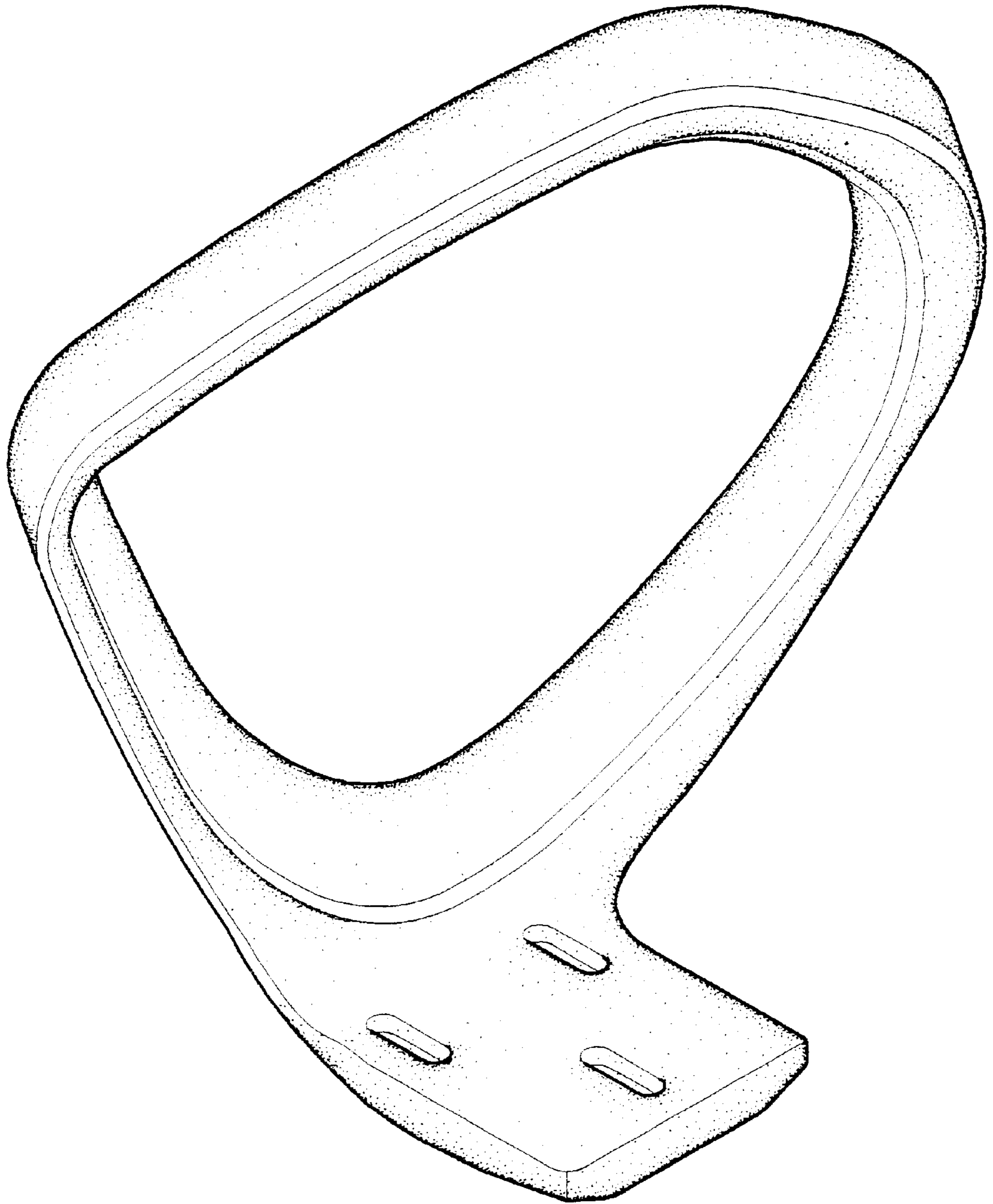

Fig. 1

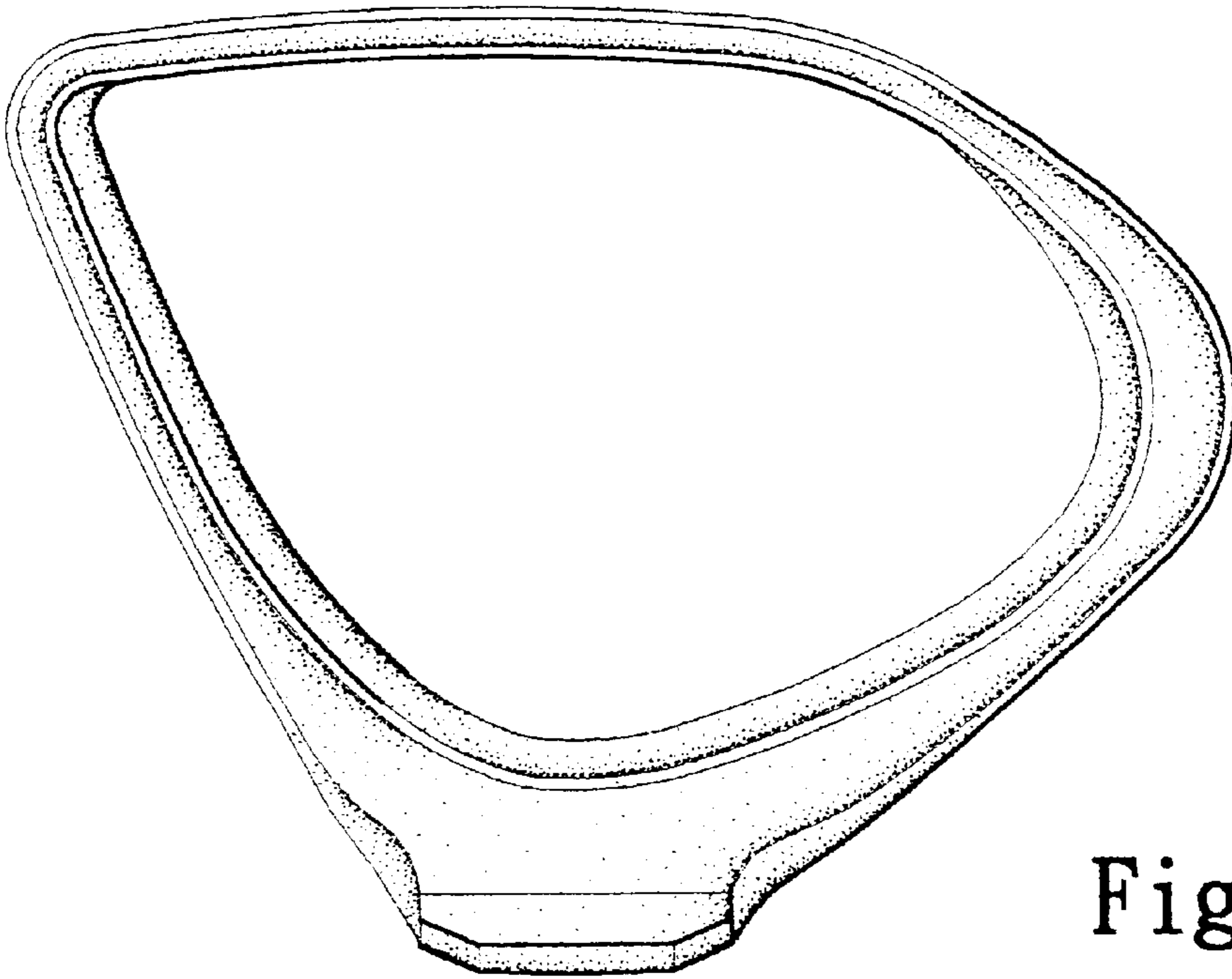

Fig. 2

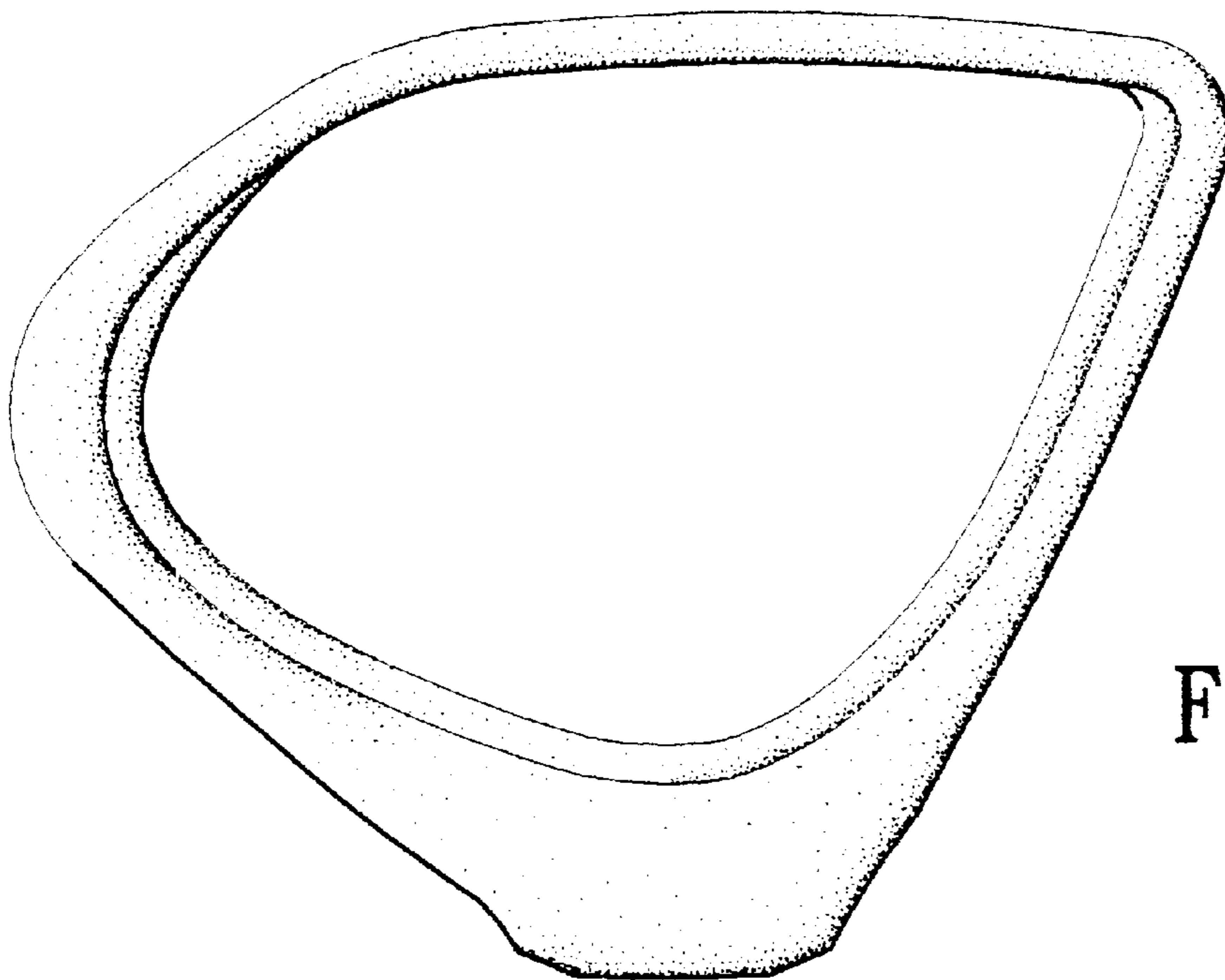

Fig. 3

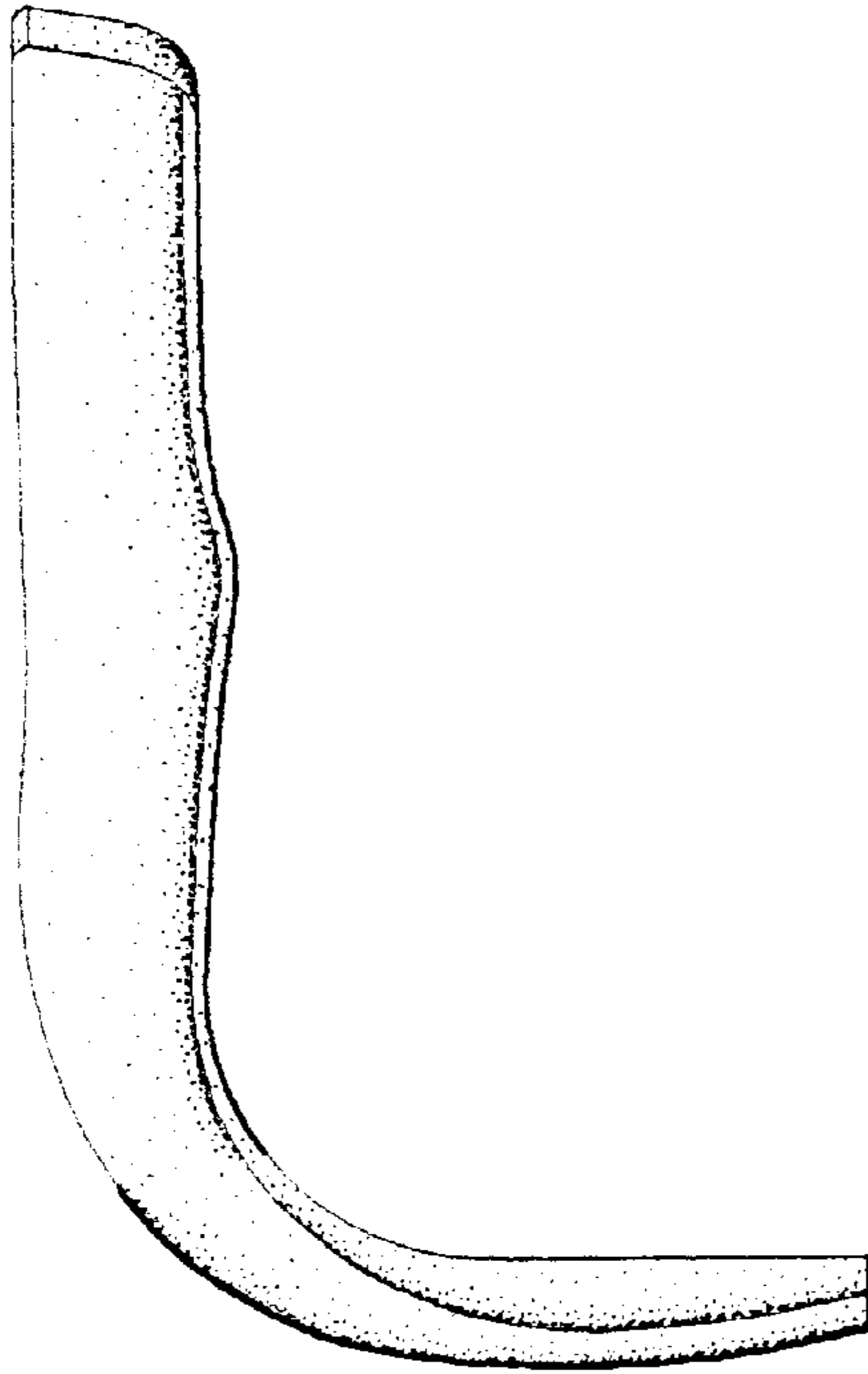

Fig. 4

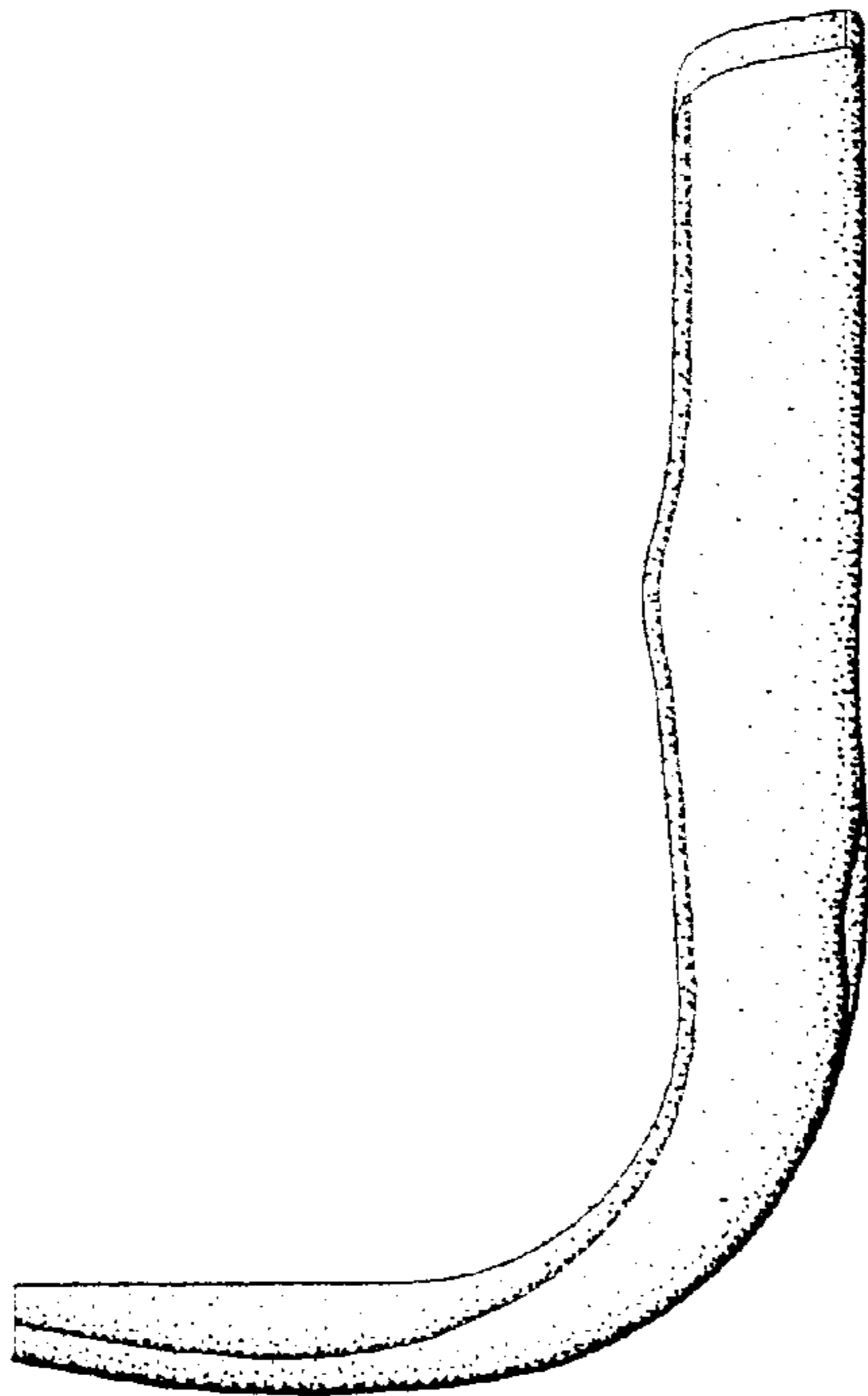

Fig. 5

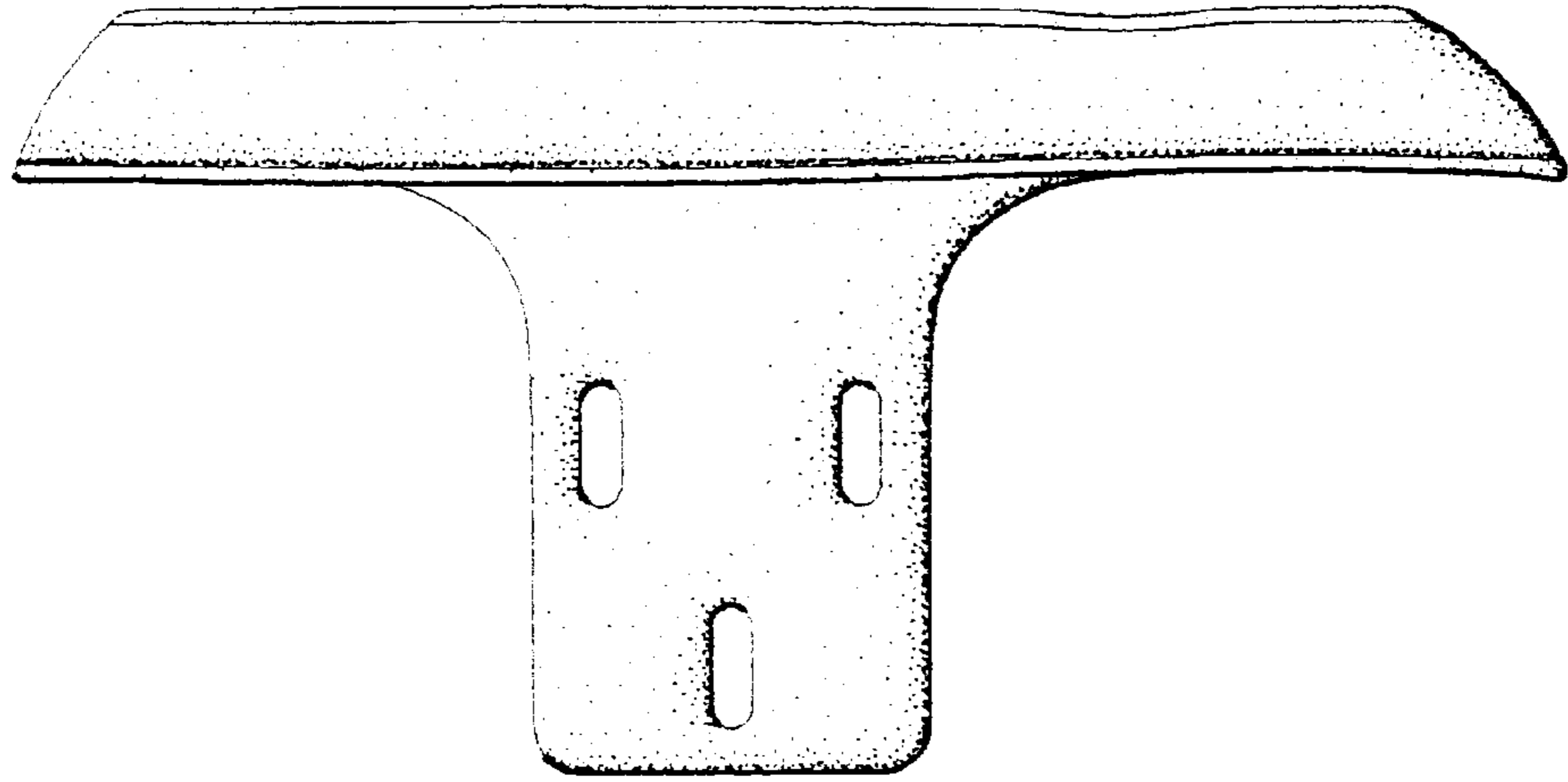

Fig. 6

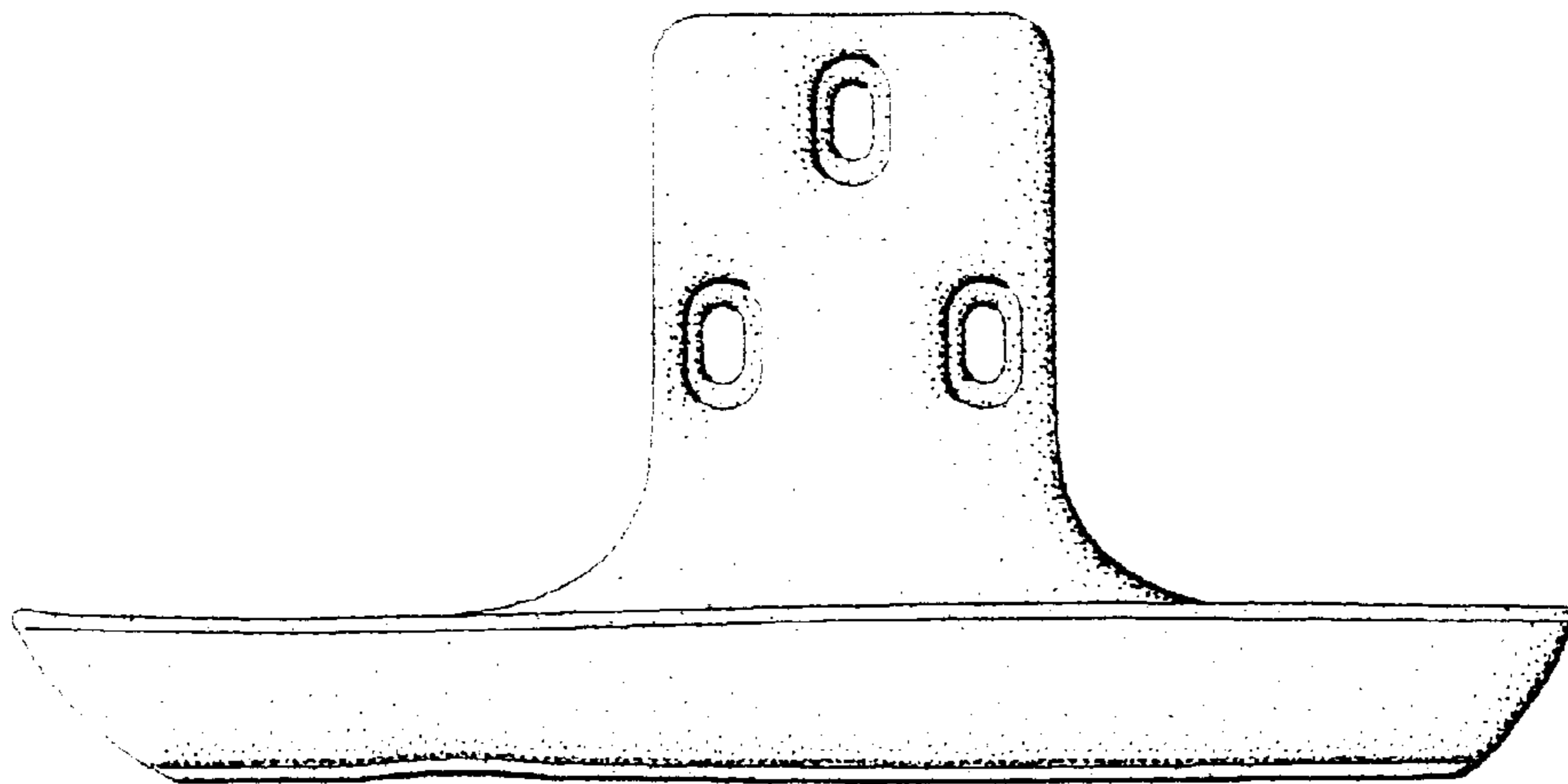

Fig. 7