



US00D413212S

United States Patent [19]

Dame et al.

[11] Patent Number: Des. 413,212

[45] Date of Patent: ** Aug. 31, 1999

[54] TABLE

[75] Inventors: Paul G. Dame, Holland, Mich.; Eric P. Chan, New York, N.Y.

[73] Assignee: Herman Miller Inc., Zeeland, Mich.

[**] Term: 14 Years

[21] Appl. No.: 29/088,767

[22] Filed: Jun. 1, 1998

[51] LOC (6) Cl. 06-03

[52] U.S. Cl. D6/487; D6/482

[58] Field of Search D6/480-489, 495-499, D6/511; 108/153.1, 155, 156, 157.1, 158.11, 161; 248/188, 188.1, 188.8

[56] **References Cited**

U.S. PATENT DOCUMENTS

D. 175,110	7/1955	Howard	D6/483
D. 272,102	1/1984	Olivan	D34/32
D. 401,086	11/1998	Hellwig et al.	D6/482
5,598,790	2/1997	Fich	108/153

Primary Examiner—Janice E. Seeger
Attorney, Agent, or Firm—Brinks Hofer Gilson & Lione

[57] **CLAIM**

The ornamental design for a table, as shown and described.

DESCRIPTION

FIG. 1 is a front perspective view showing an embodiment of my new design.
 FIG. 2 is a bottom perspective view of the embodiment shown in FIG. 1;
 FIG. 3 is a top view of the embodiment shown in FIGS. 1-2;
 FIG. 4 is a front view of the embodiment shown in FIGS. 1-3;
 FIG. 5 is a bottom view of the embodiment shown in FIGS. 1-4;
 FIG. 6 is a back view of the embodiment shown in FIGS. 1-5;
 FIG. 7 is a first side view of the embodiment shown in FIGS. 1-6; and,
 FIG. 8 is a second side view of the embodiment shown in FIGS. 1-7.

1 Claim, 4 Drawing Sheets

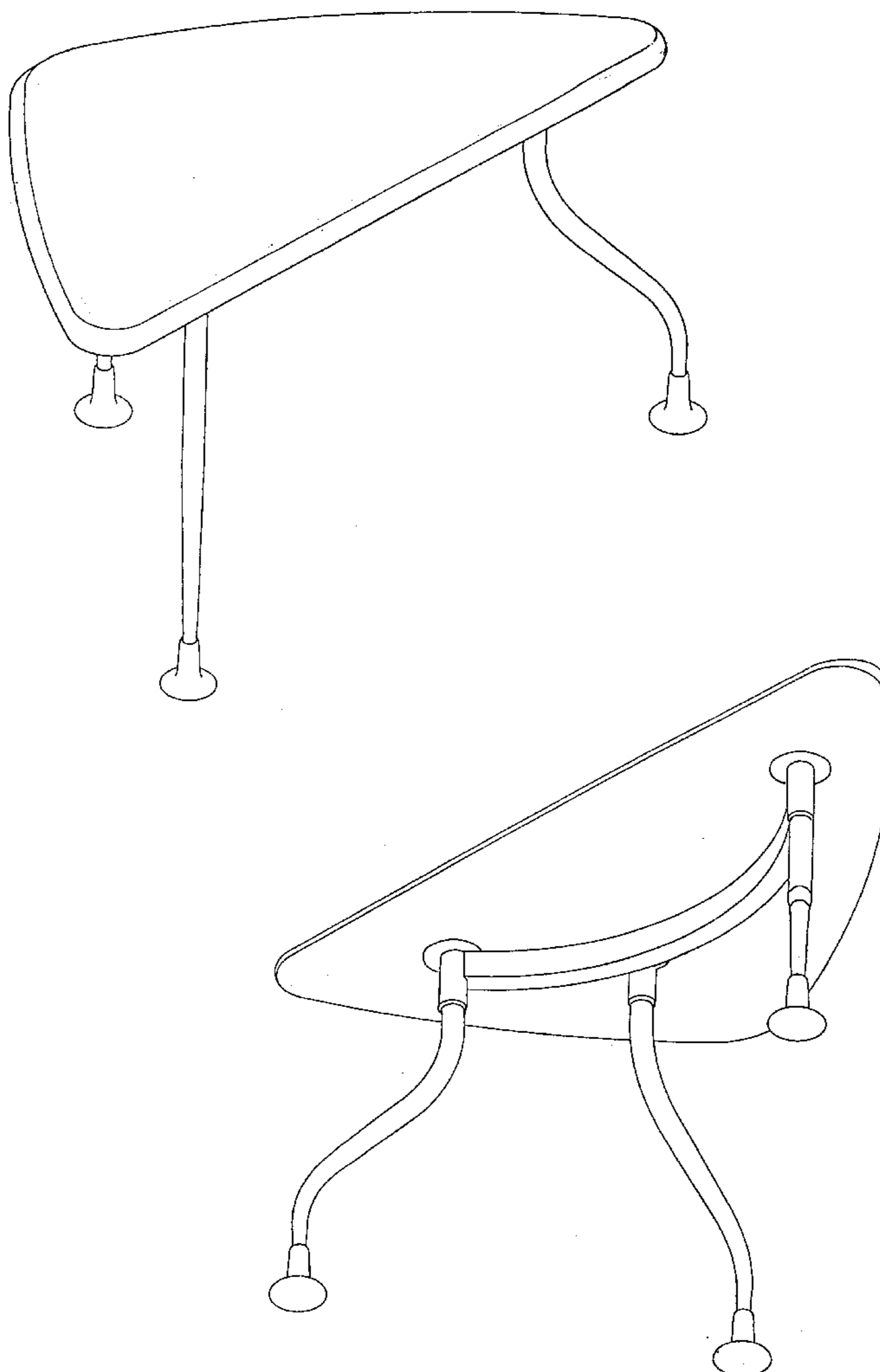

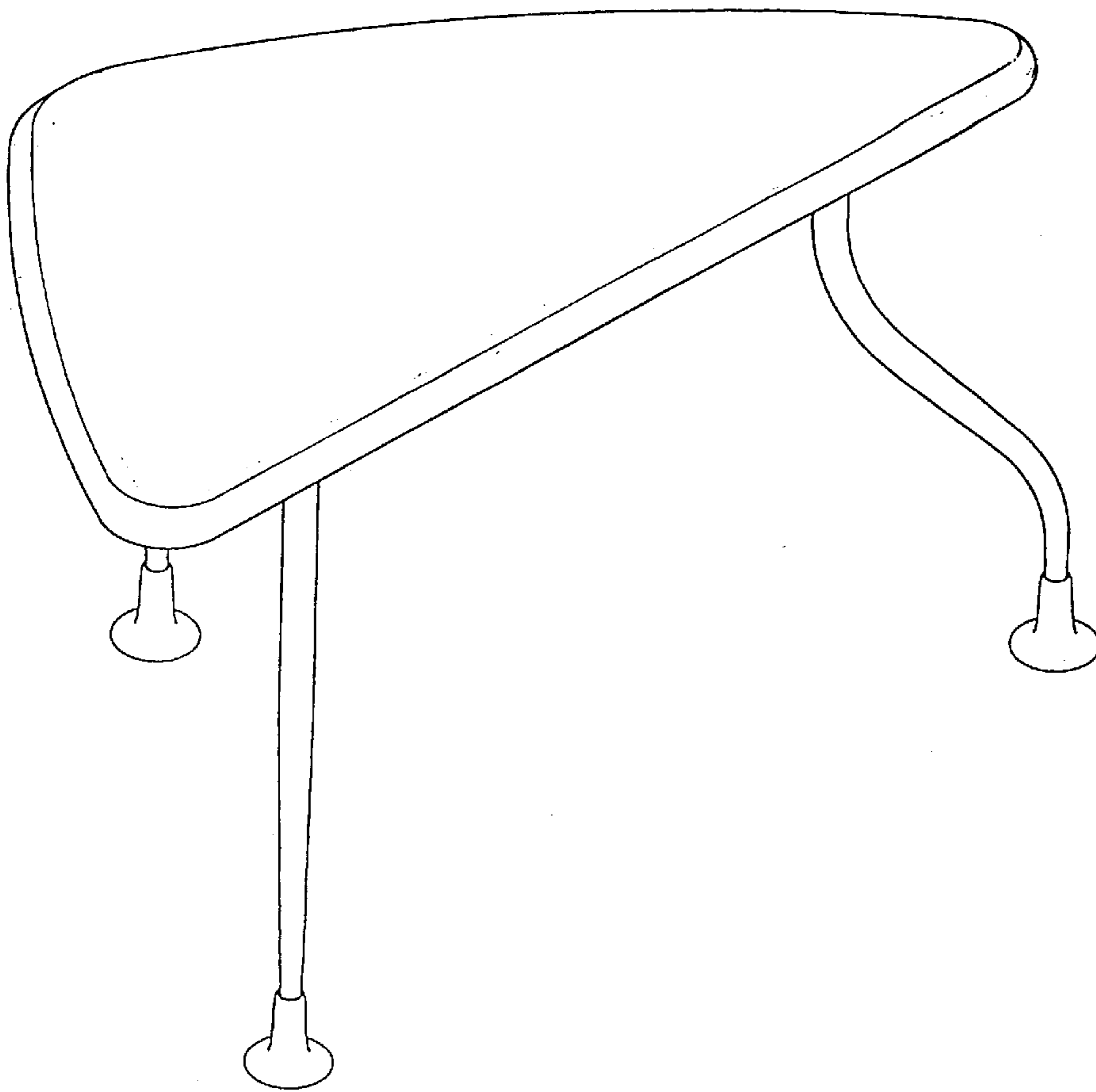

FIG. 1

FIG. 2

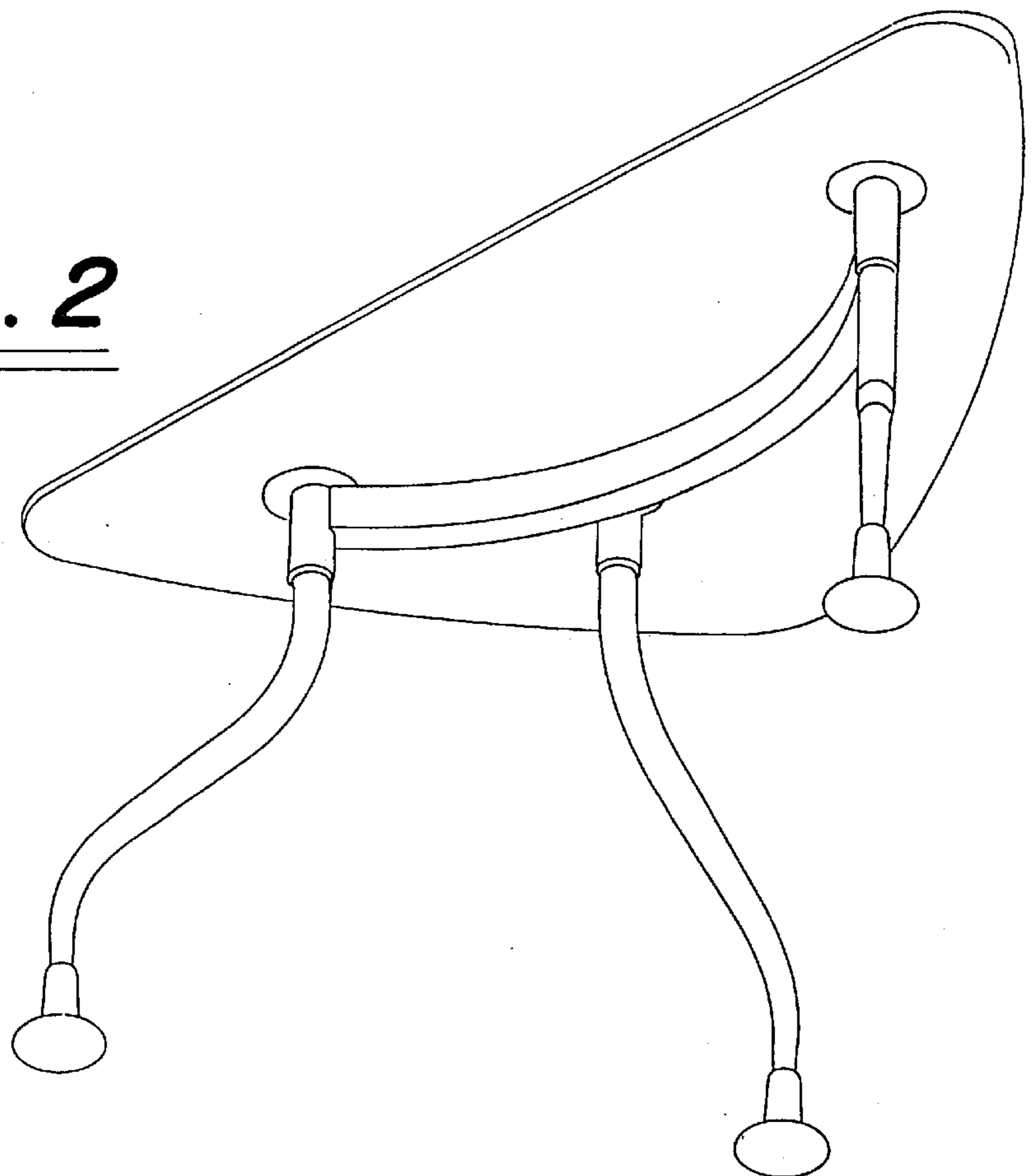

FIG. 3

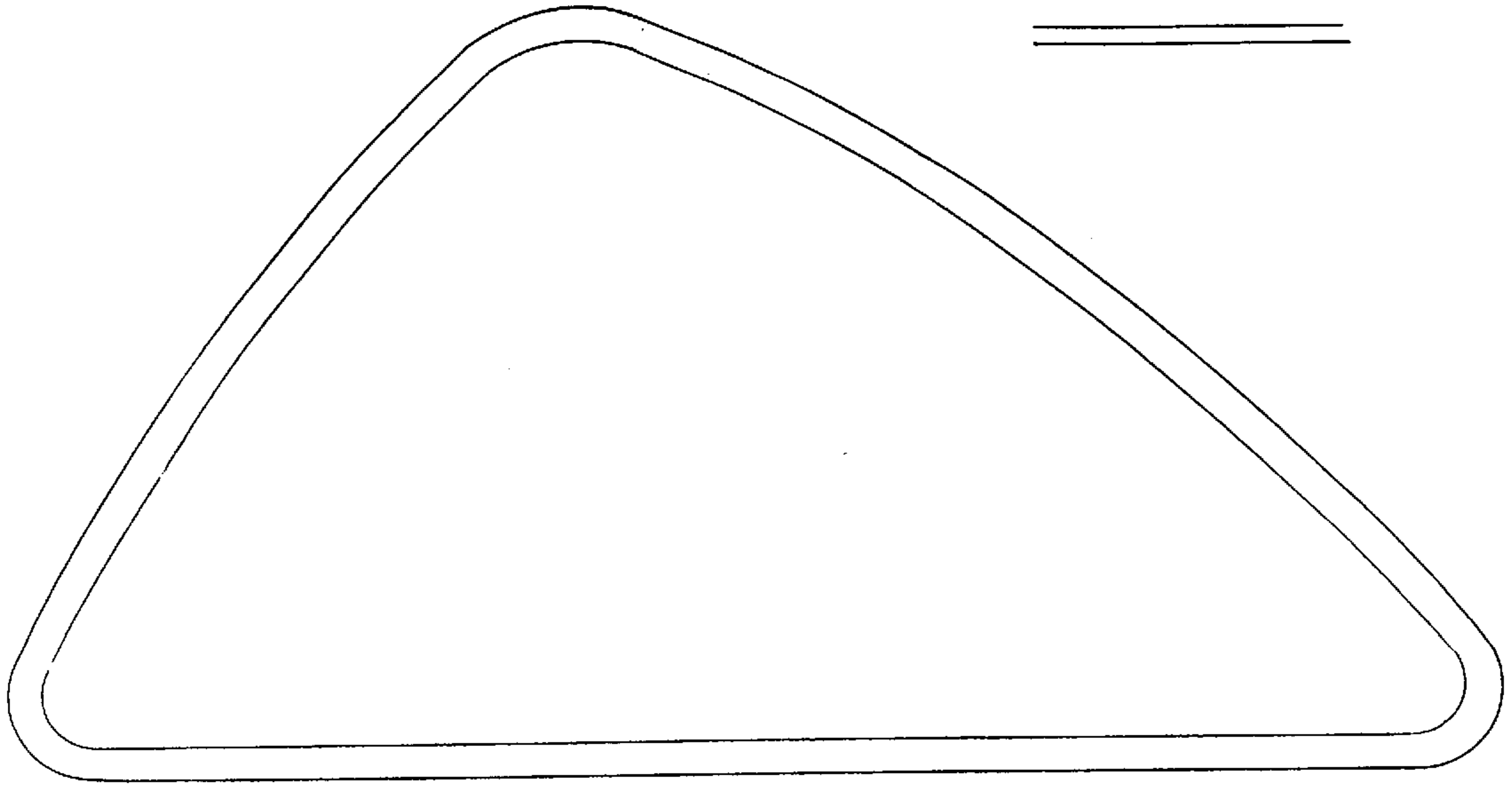

FIG. 4

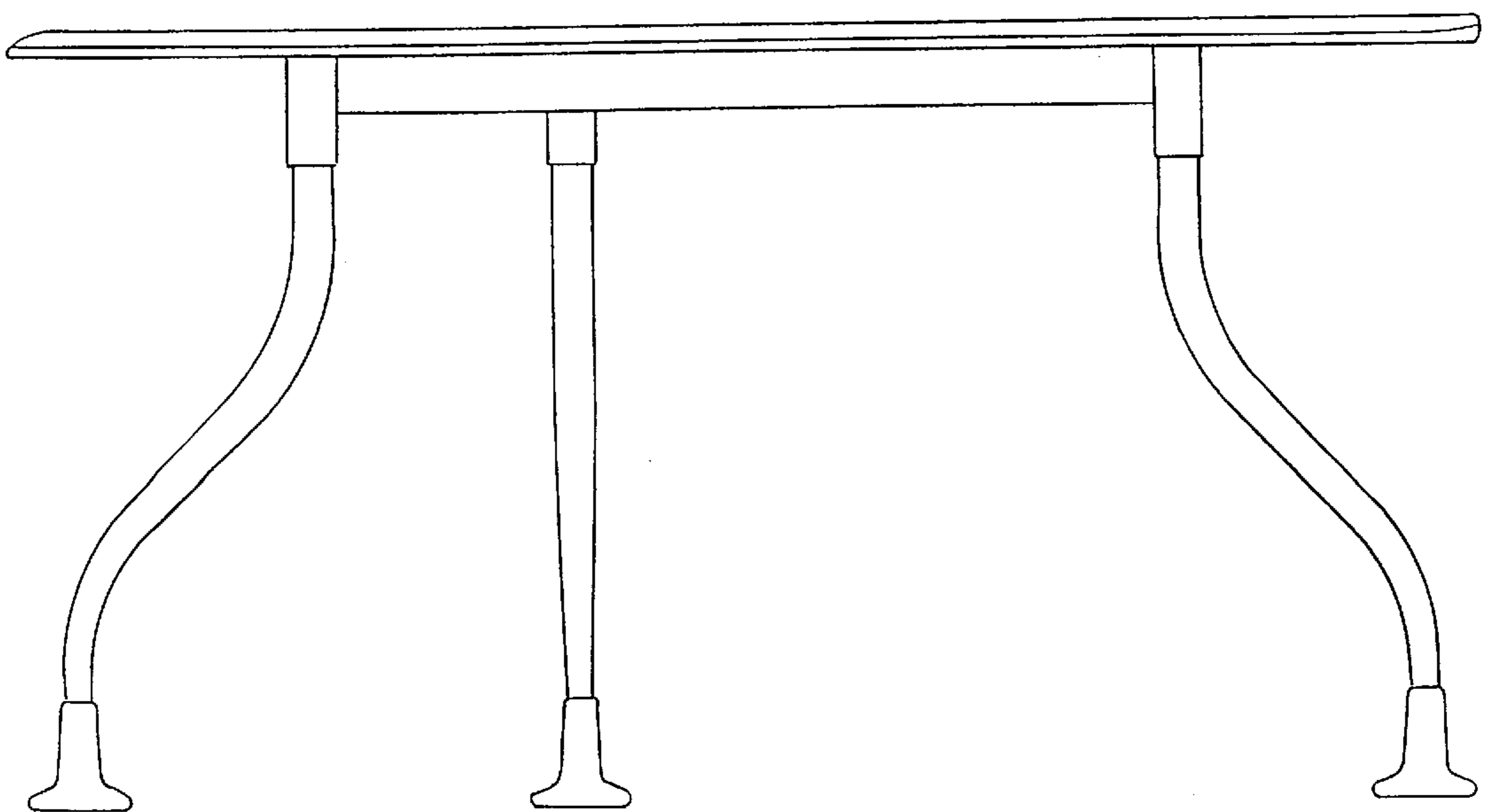

FIG. 5

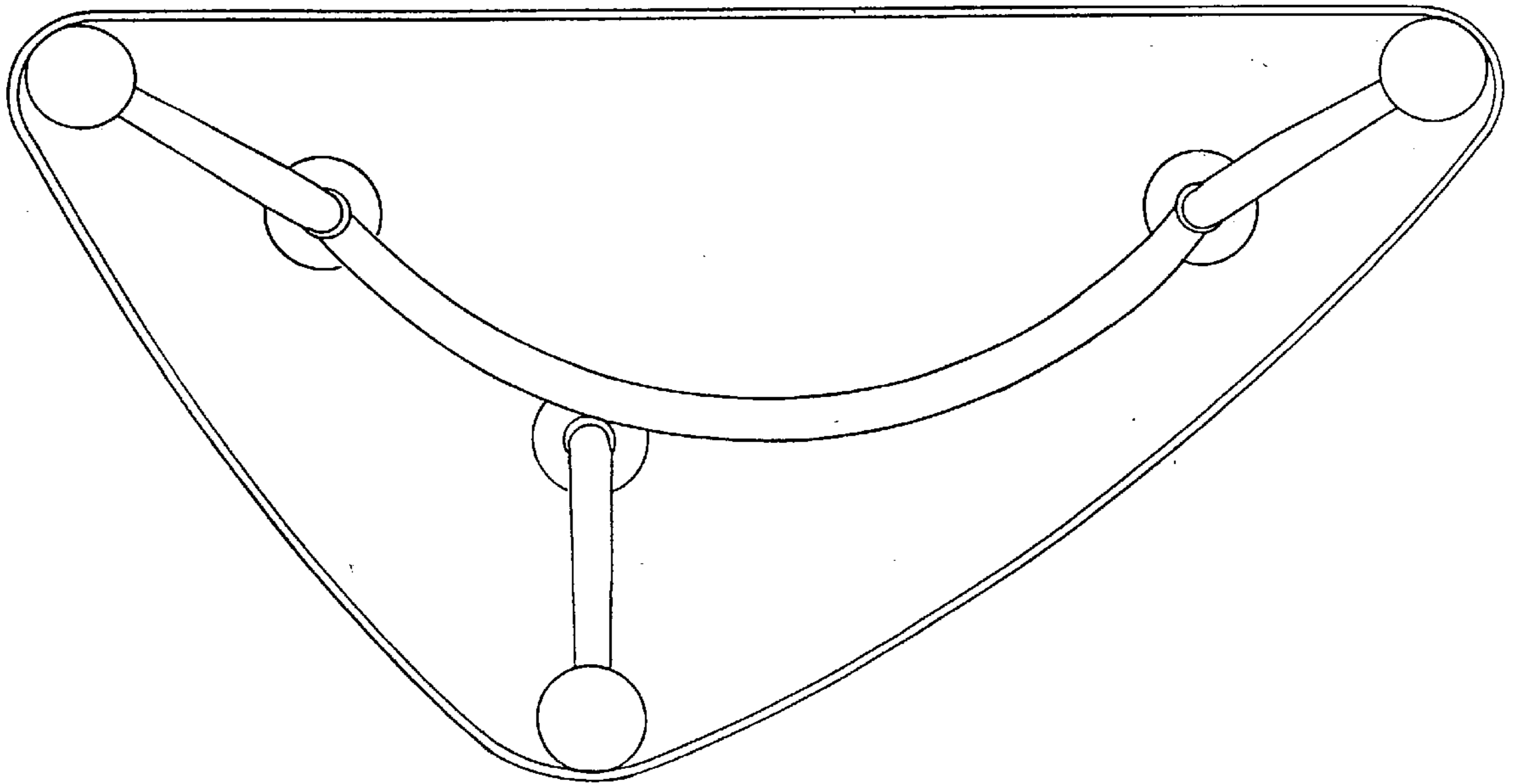

FIG. 6

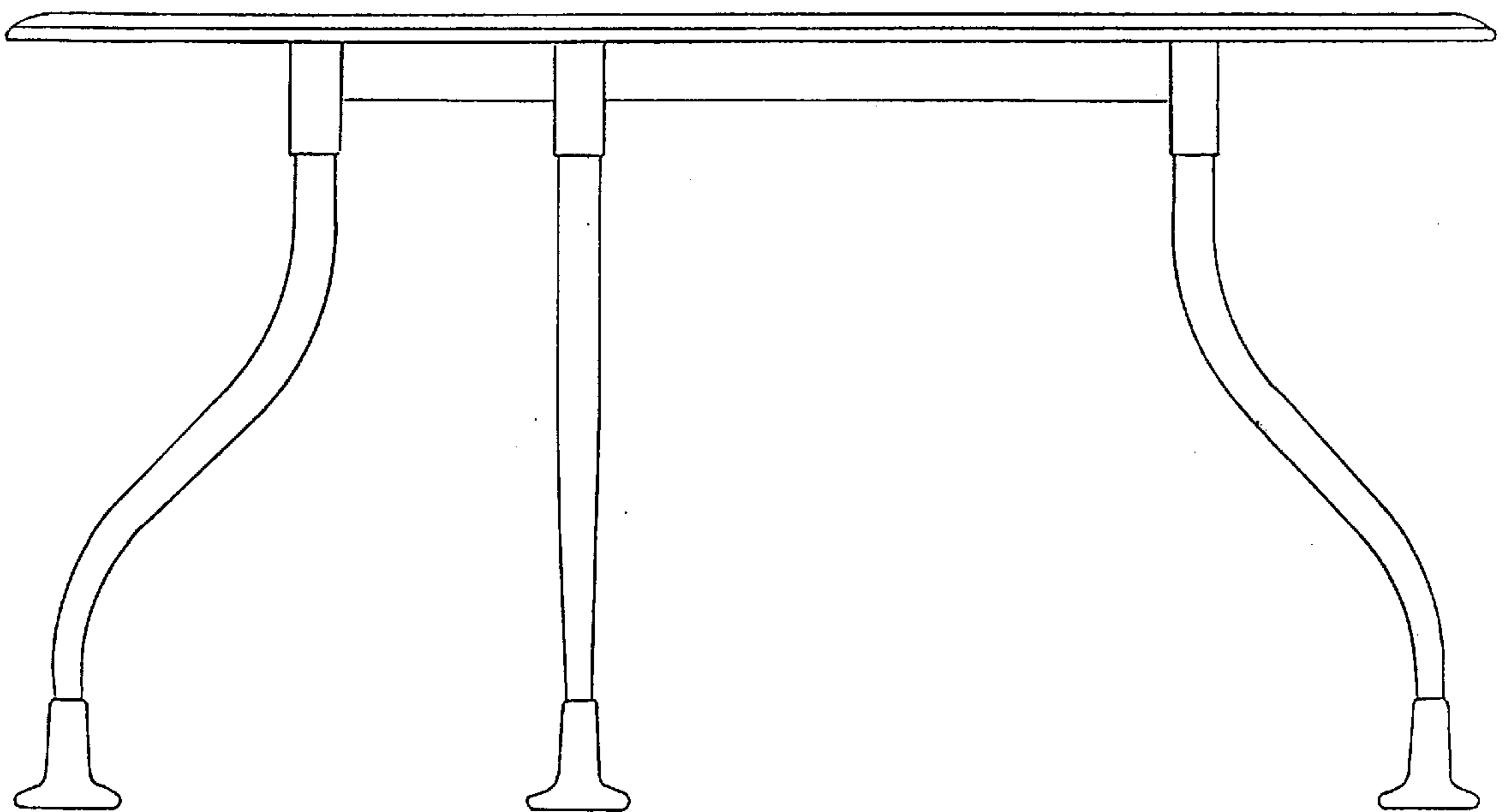

FIG. 7

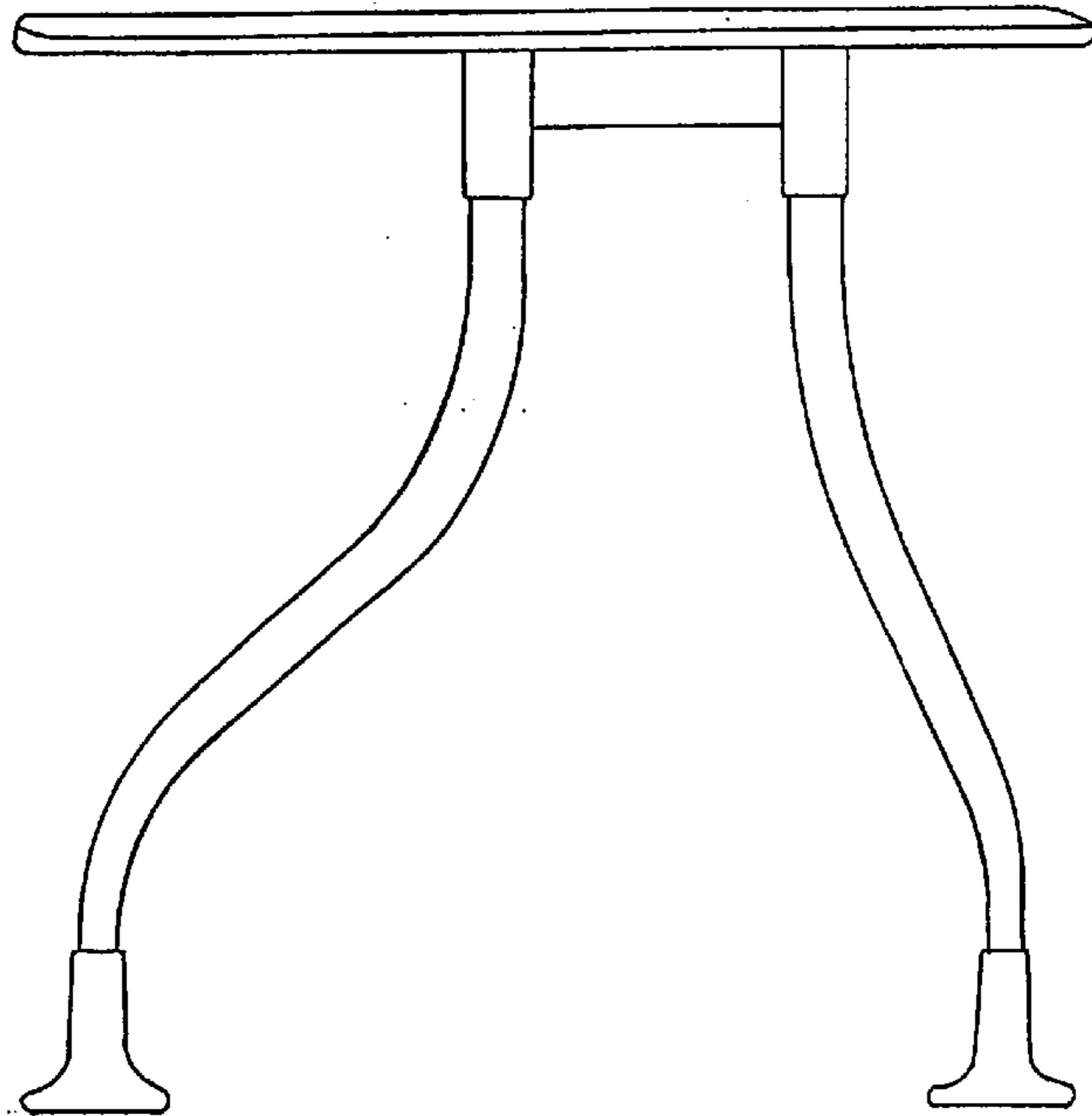

FIG. 8

