



US00D413164S

United States Patent [19] Lord

[11] **Patent Number: Des. 413,164**

[45] **Date of Patent: ** Aug. 24, 1999**

[54] **FAUCET SPOUT CAP**

[75] Inventor: **Judd A. Lord**, Carmel, Ind.

[73] Assignee: **Masco Corporation of Indiana**, Indianapolis, Ind.

[*] Notice: This patent is subject to a terminal disclaimer.

[**] Term: **14 Years**

[21] Appl. No.: **29/075,772**

[22] Filed: **Aug. 22, 1997**

[51] **LOC (6) Cl. 23-01**

[52] **U.S. Cl. D23/303; D23/260**

[58] **Field of Search D23/303, 308, D23/238-243, 250-257; 4/675-678, 244.2; 138/89, 89.1-89.3, 96 R, 96 T; 137/382.5, 381, 375, 382; 220/724, 726; D8/397, 399, 394; 16/121**

[56] **References Cited**

U.S. PATENT DOCUMENTS

D. 148,252	12/1947	Rausch	D23/250
D. 170,468	9/1953	Gries	D8/397
D. 269,696	7/1983	Niemann	D23/250
D. 288,902	3/1987	Lewis	D8/397
D. 340,007	10/1993	Gershenson	D8/394
D. 354,113	1/1995	Nortier et al.	D23/233
D. 359,342	6/1995	Doughty et al.	D23/241
D. 374,172	10/1996	Frattarola	D8/397
D. 384,133	9/1997	Doughty et al.	D23/241
4,103,701	8/1978	Jeng	137/375
4,593,430	6/1986	Spangler et al.	16/121

Primary Examiner—Louis S. Zarfes
Assistant Examiner—Eric Watterson

Attorney, Agent, or Firm—Myron B. Kapustij; Leon E. Redman

[57] **CLAIM**

The ornamental design for a faucet spout cap, as shown and described.

DESCRIPTION

FIG. 1 is a top perspective view of a faucet spout cap showing my new design;
 FIG. 2 is a front elevational view thereof;
 FIG. 3 is a side elevational view thereof;
 FIG. 4 is a top plan view thereof;
 FIG. 5 is a front elevational view of a second embodiment of the two handle faucet spout cap differing from that illustrated in FIG. 1 in having 4 scallops instead of two scallops;
 FIG. 6 is a side elevational view of the second embodiment illustrated in FIG. 5;
 FIG. 7 is a top plan view of the second embodiment;
 FIG. 8 is a cross-sectional view taken along line 8—8 in FIG. 4;
 FIG. 9 is a front elevational view of a third embodiment of the two handle faucet spout cap, differing from that illustrated in FIG. 1 in having 6 scallops instead of two scallops;
 FIG. 10 is a side elevational view of the third embodiment illustrated in FIG. 9;
 FIG. 11 is a top plan view of the third embodiment;
 FIG. 12 is a front elevational view of a fourth embodiment of the two handle spout cap, differing from that illustrated in FIG. 1 in having 8 scallops instead of two scallops;
 FIG. 13 is a side elevational view of the fourth embodiment illustrated in FIG. 12; and,
 FIG. 14 is a top plan view of the fourth embodiment.
 The broken line showing of the faucet and handles in FIG. 1 is for purposes of illustration only and forms no part of the claimed design.

1 Claim, 3 Drawing Sheets

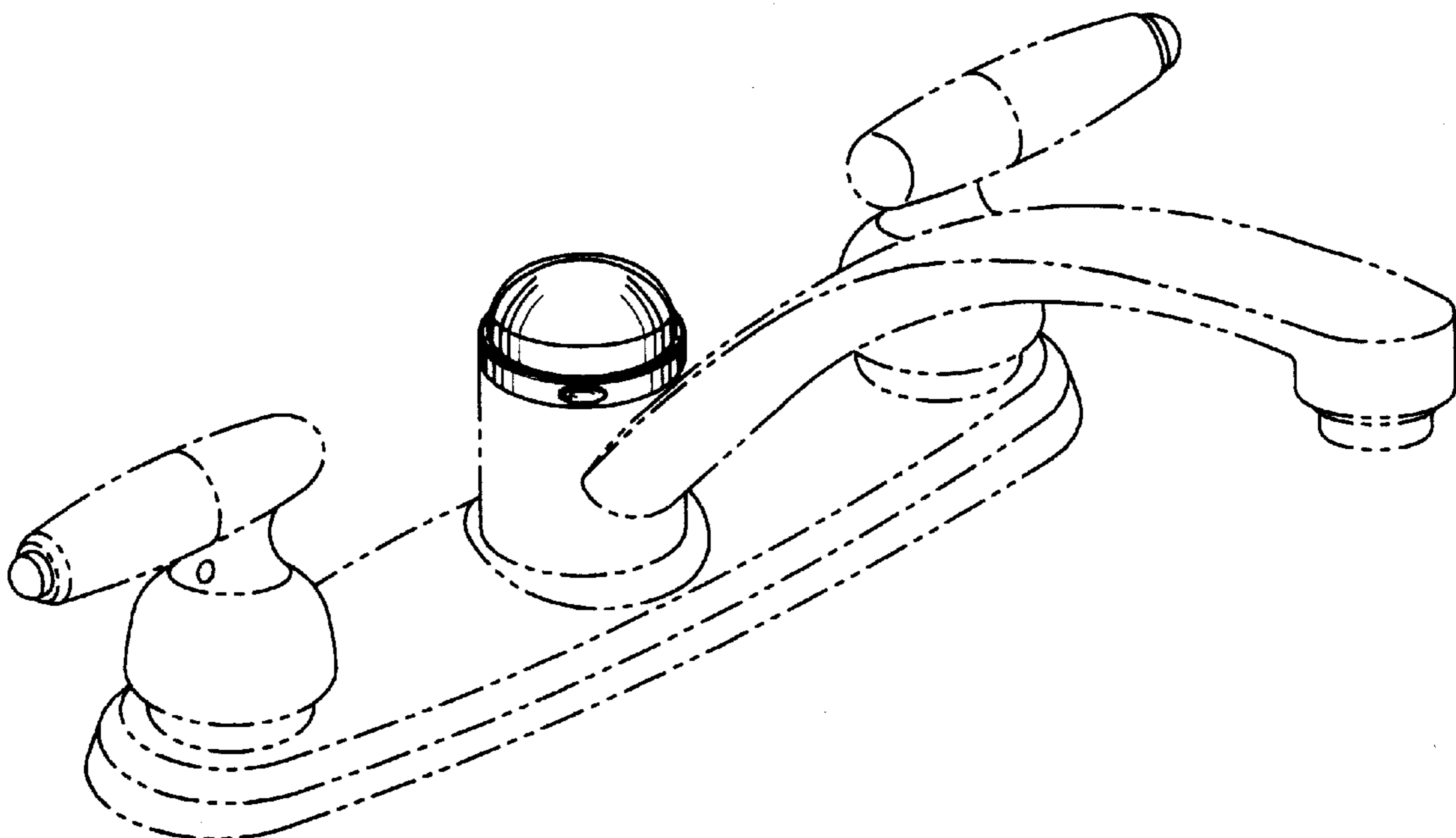

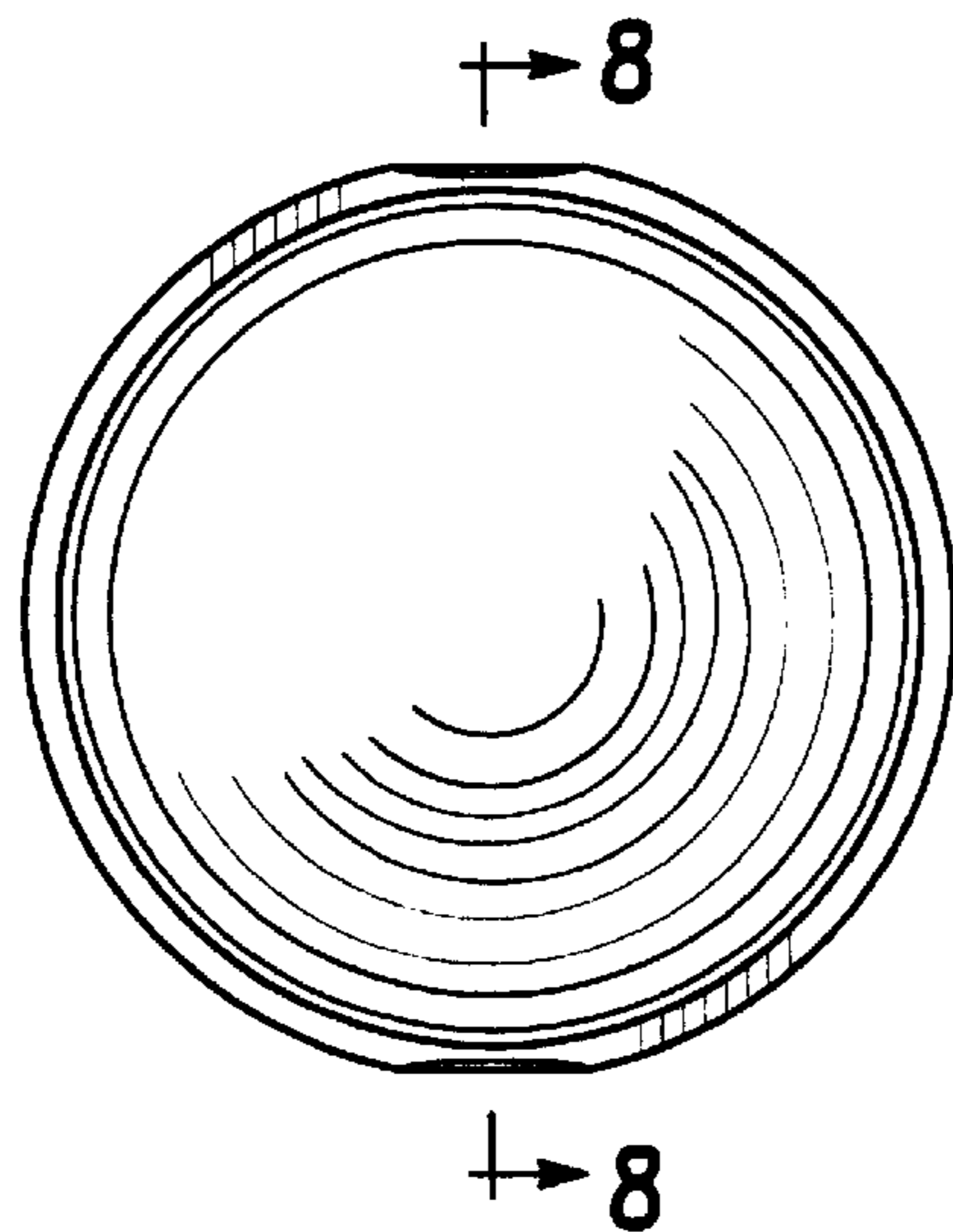
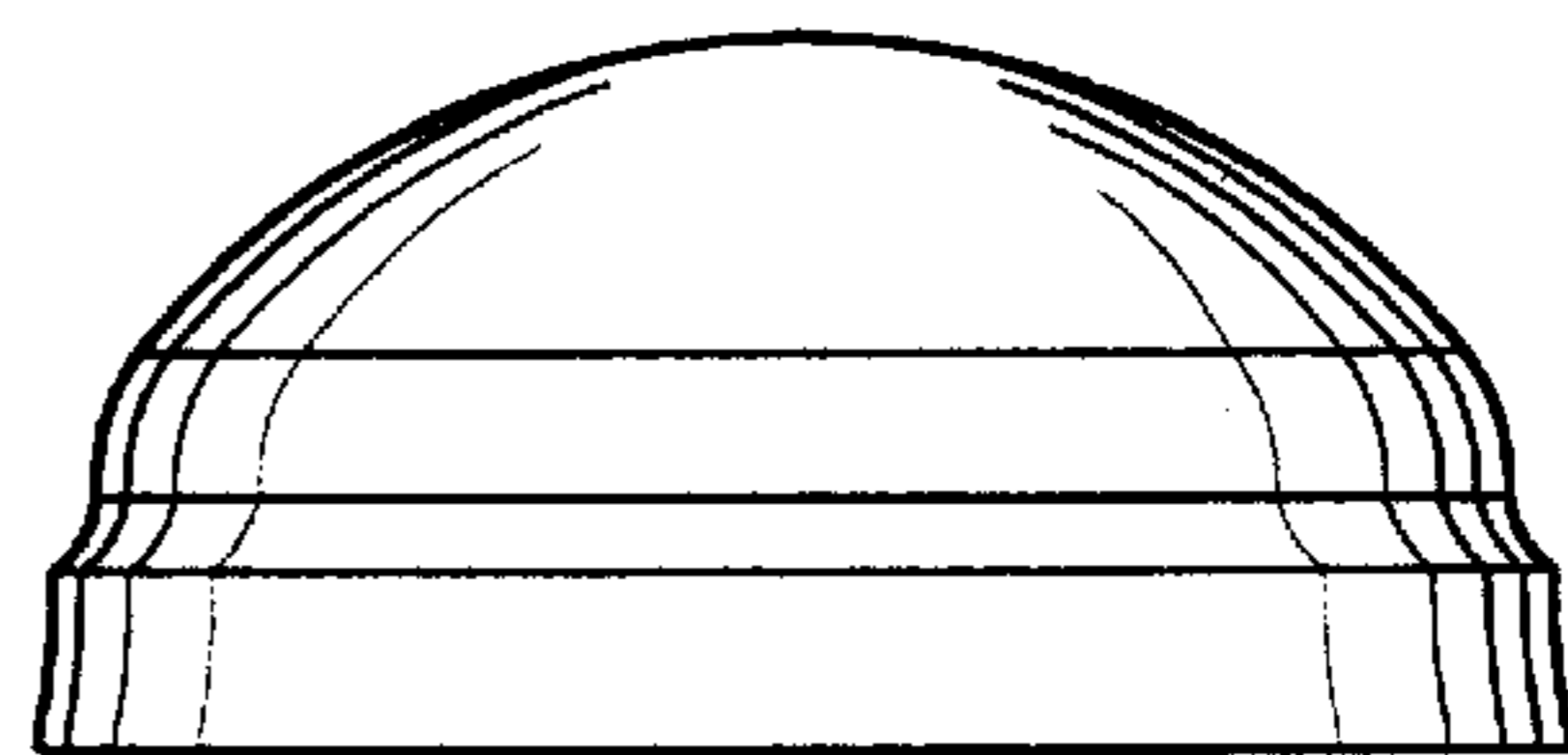
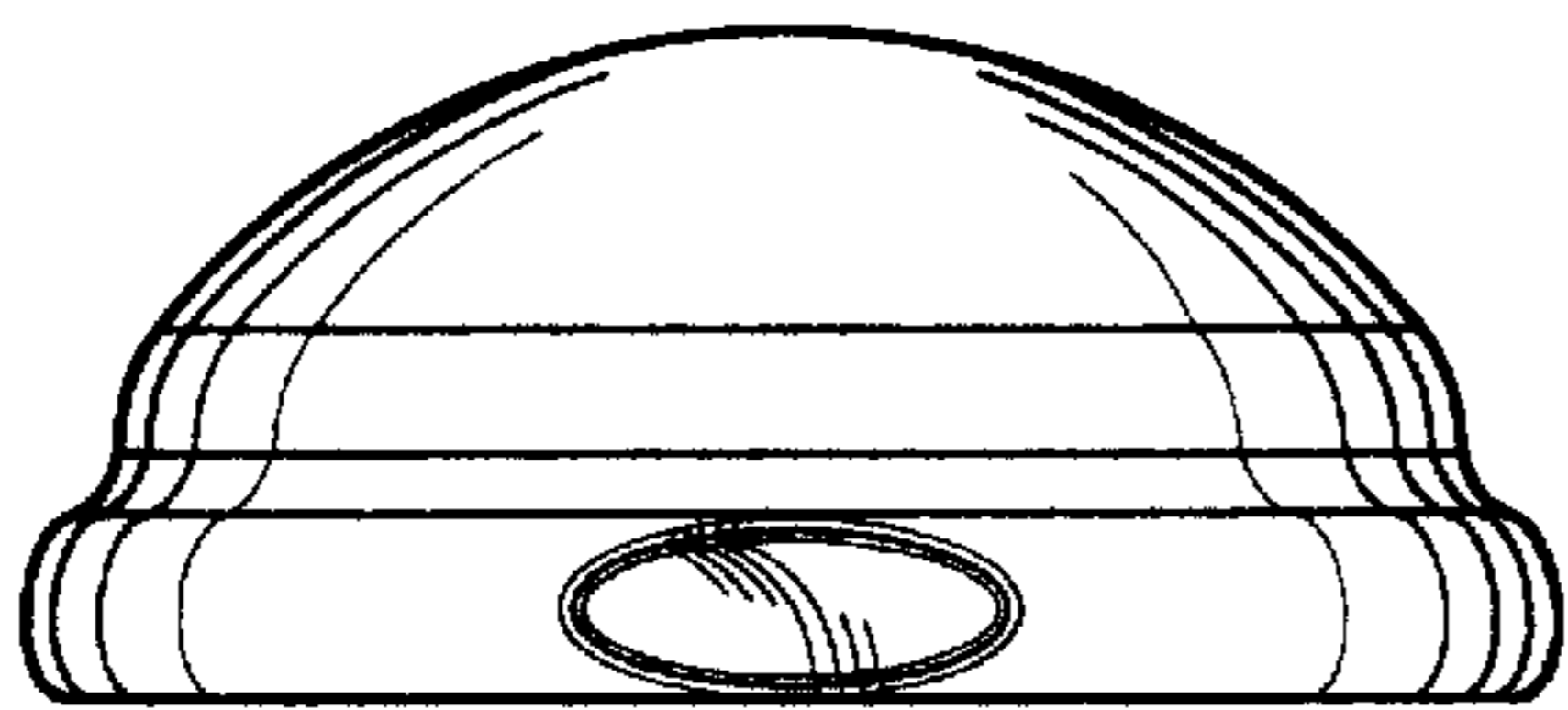
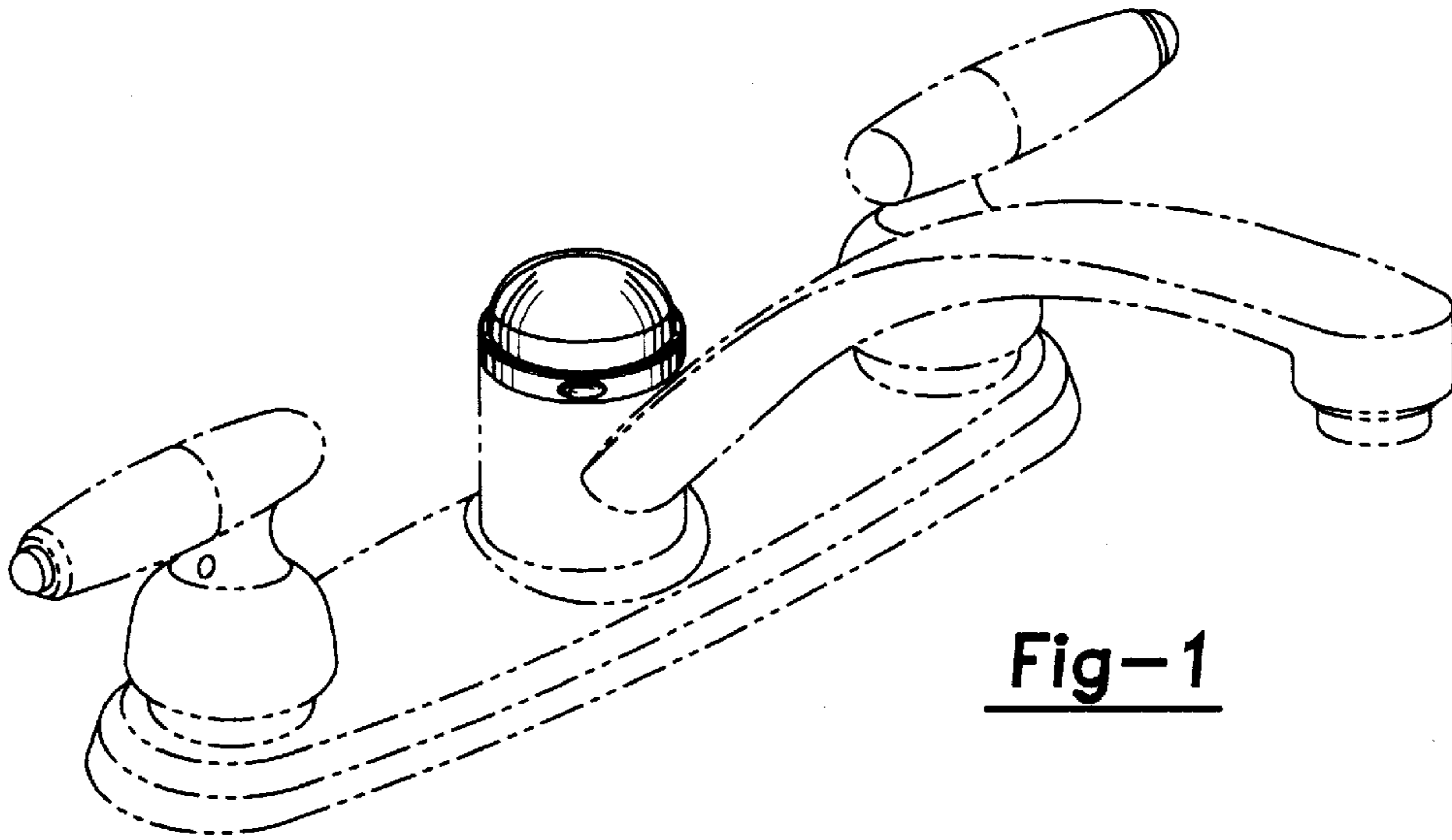

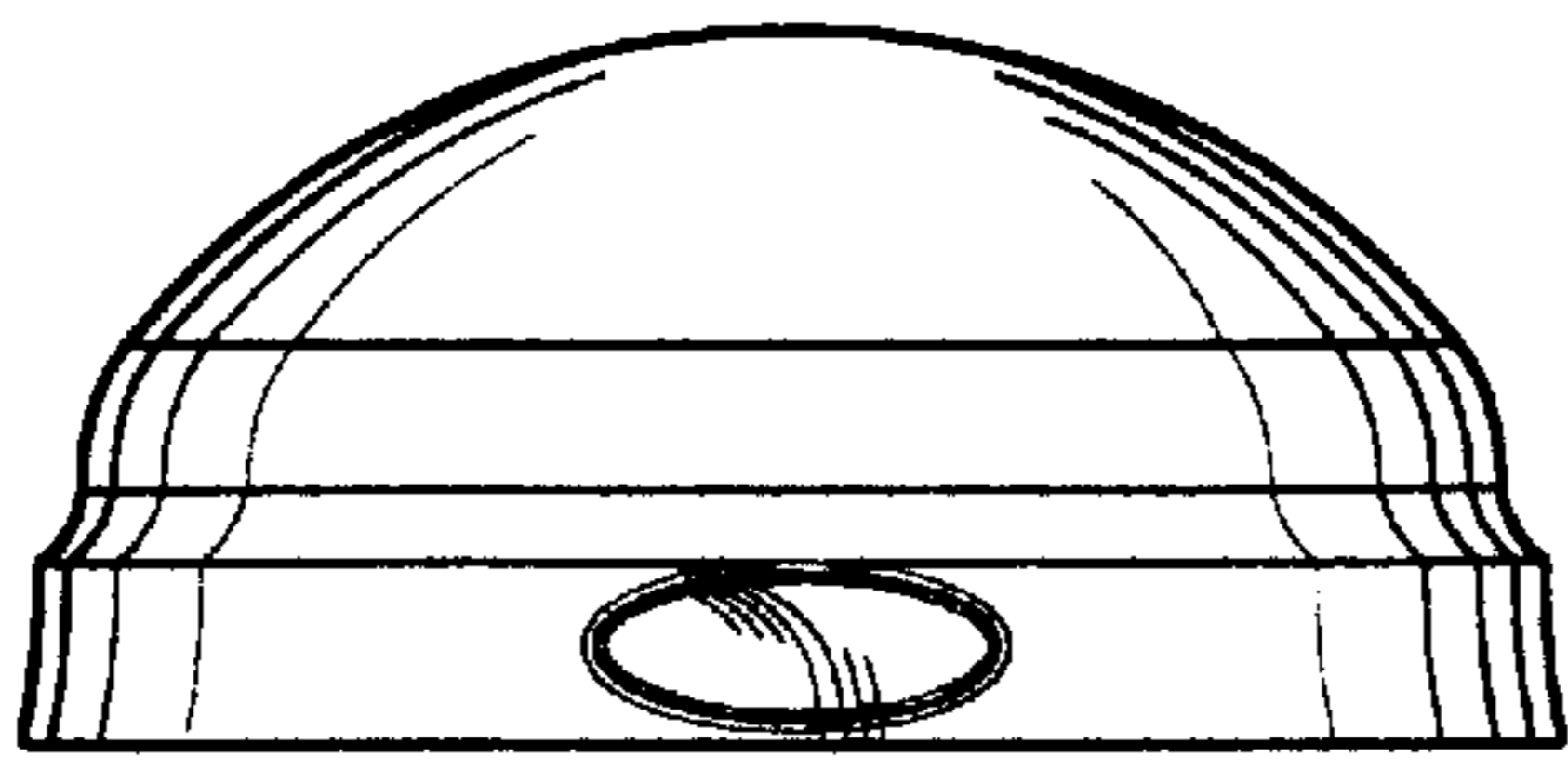

Fig-5

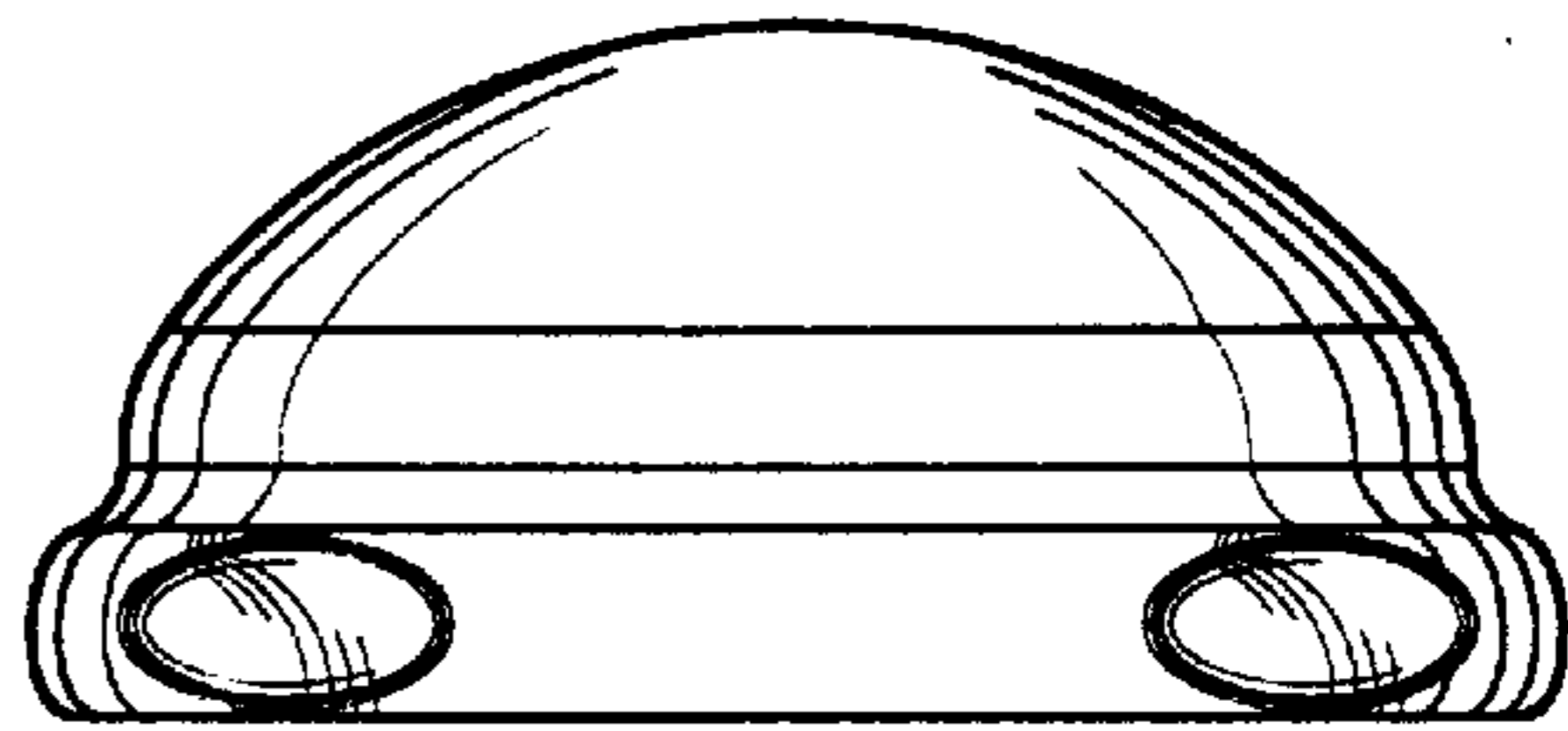

Fig-6

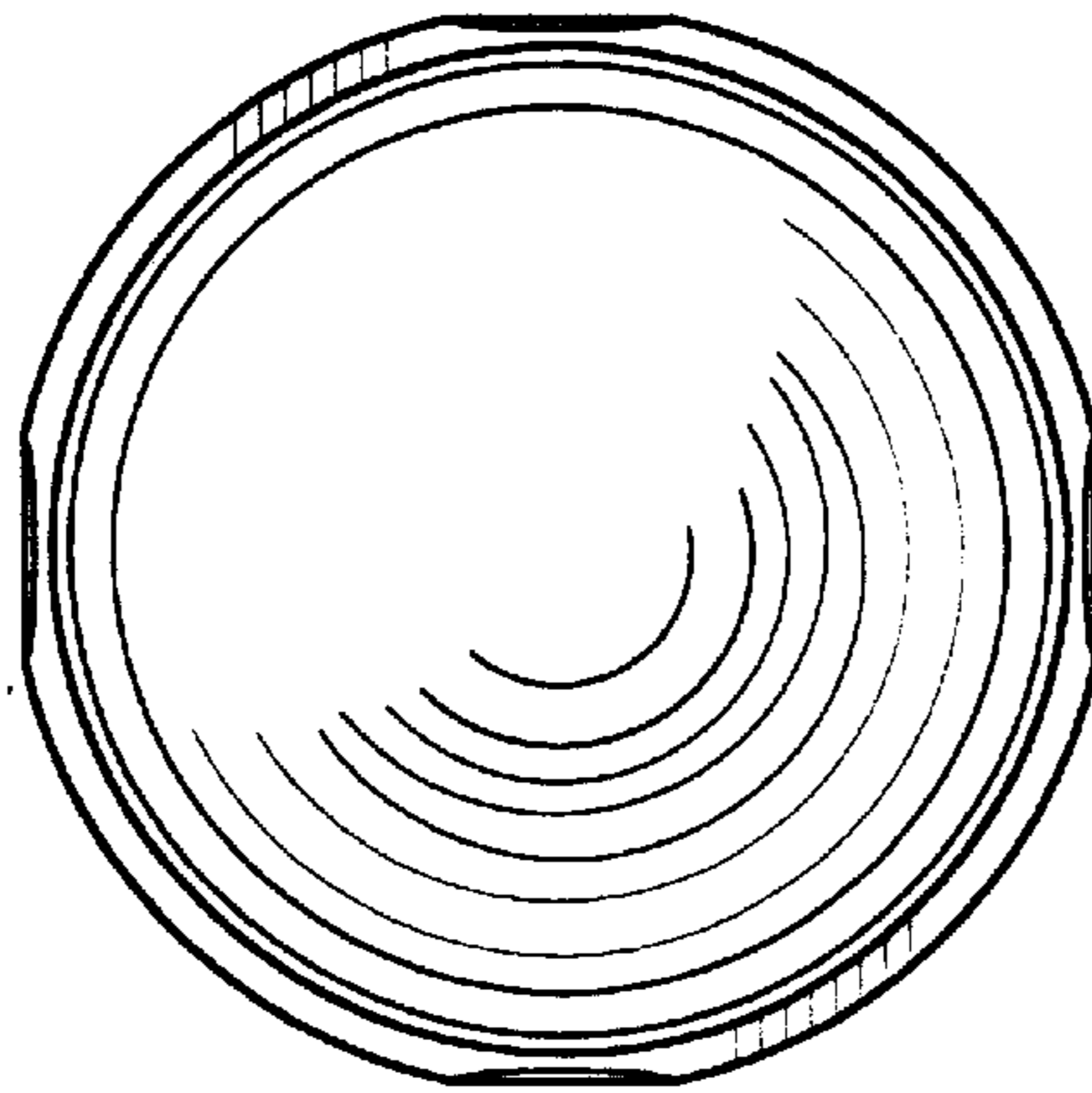

Fig-7

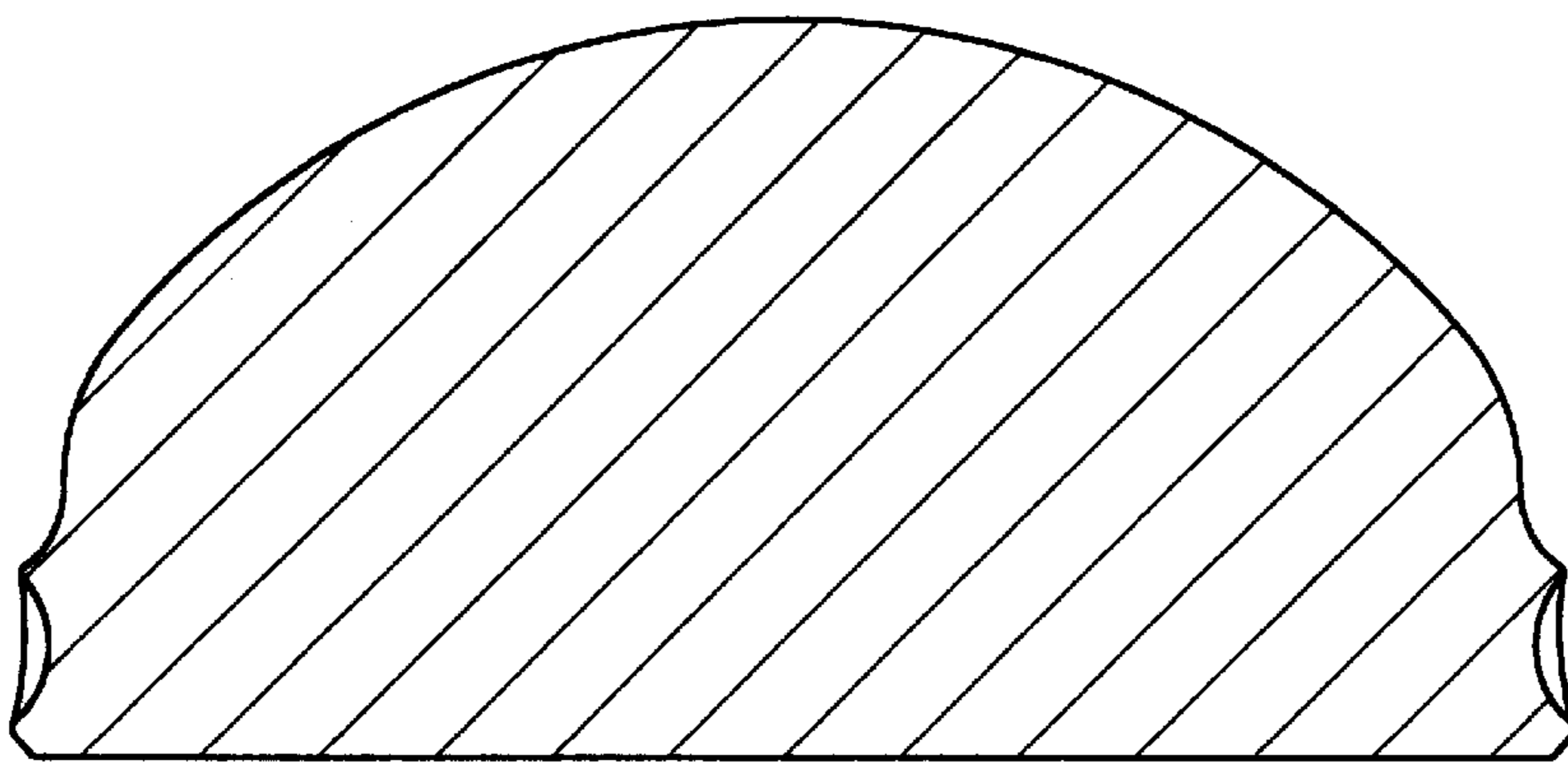

Fig-8

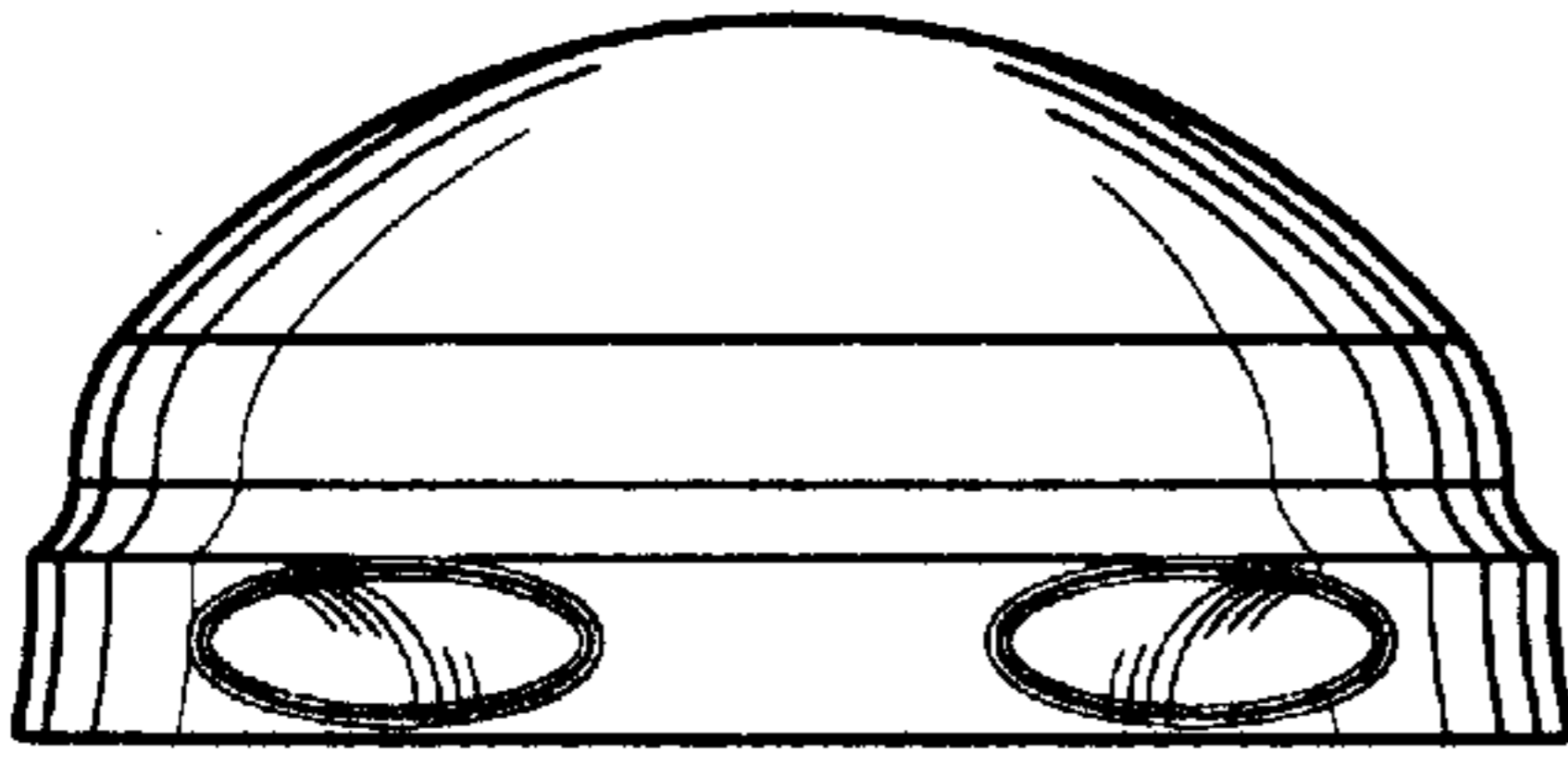

Fig-9

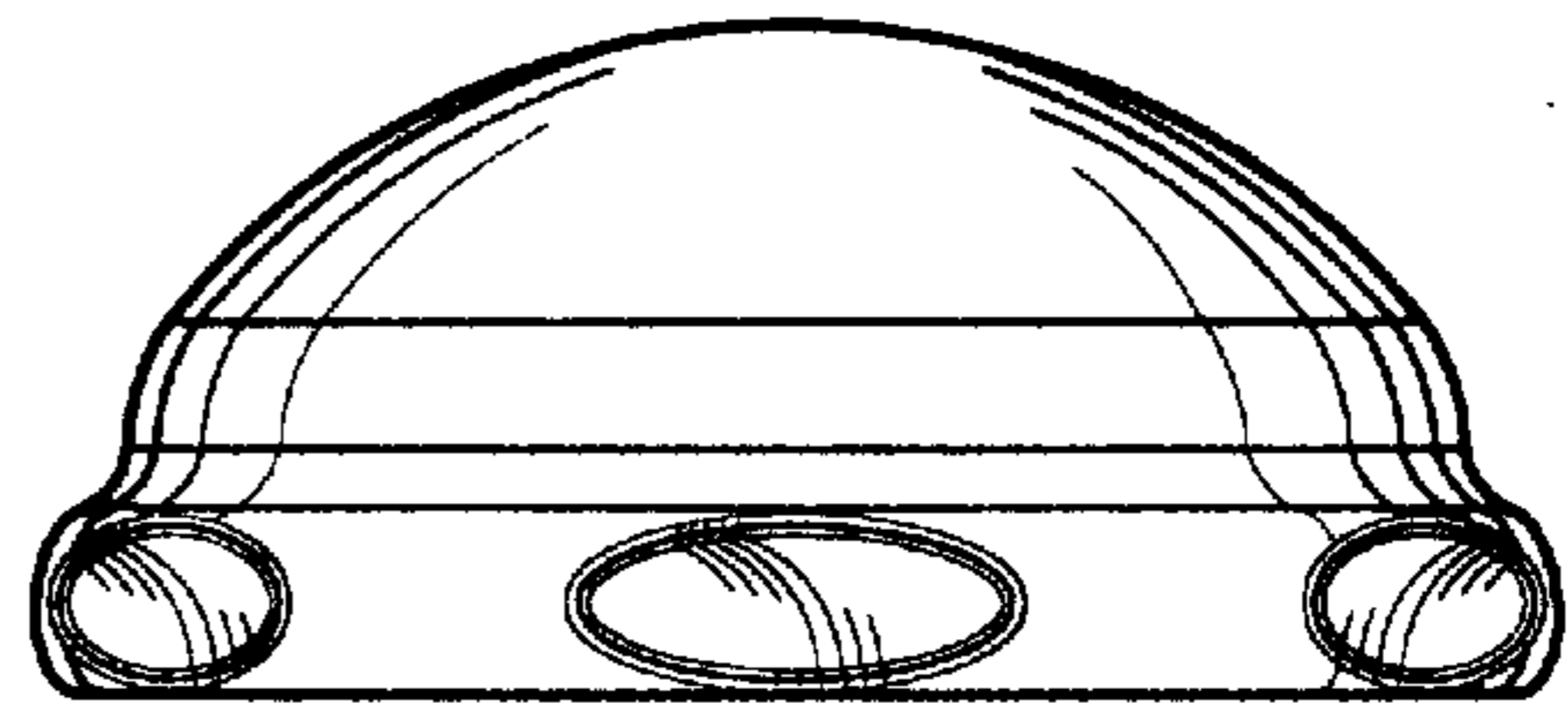

Fig-10

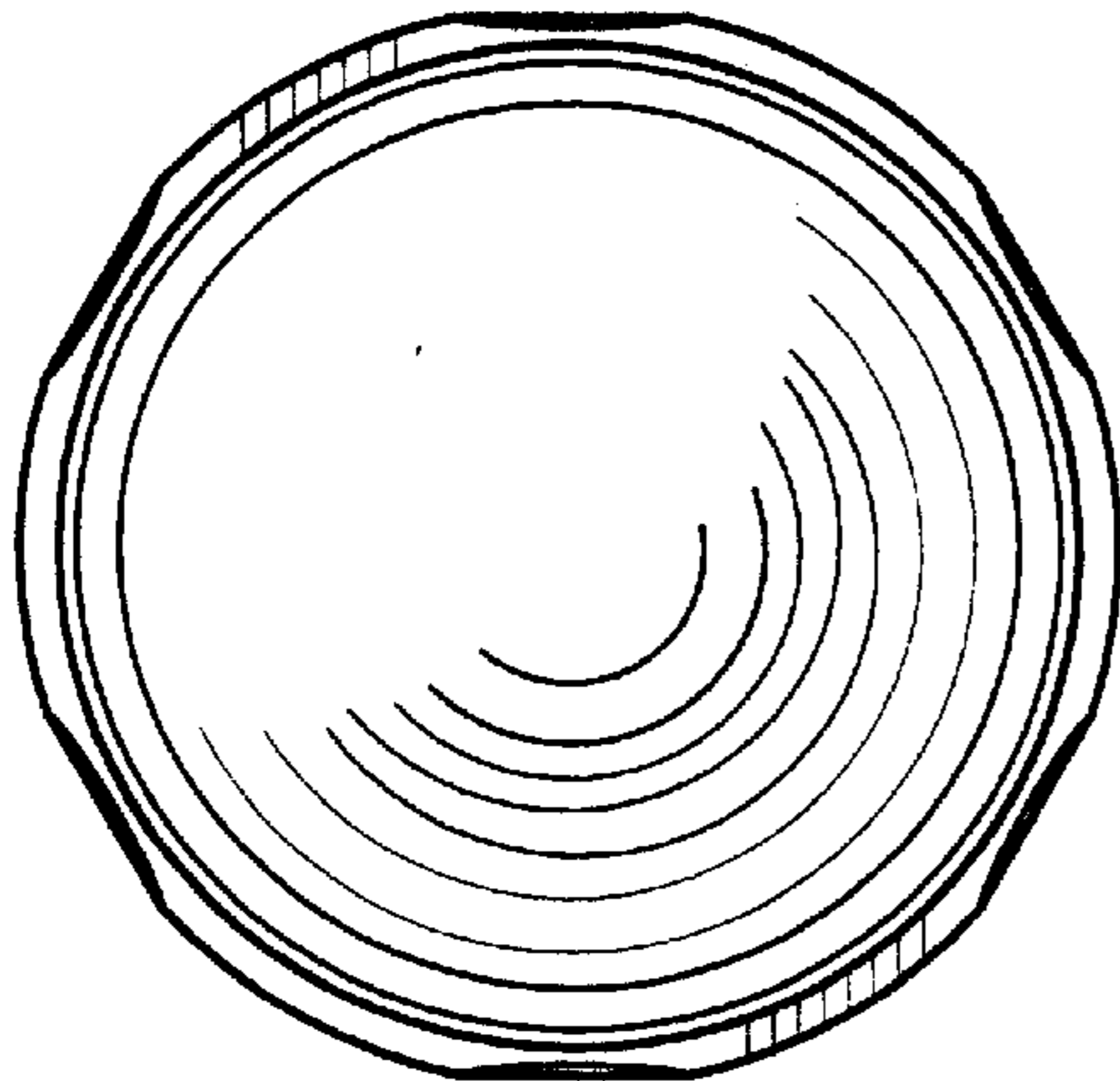

Fig-11

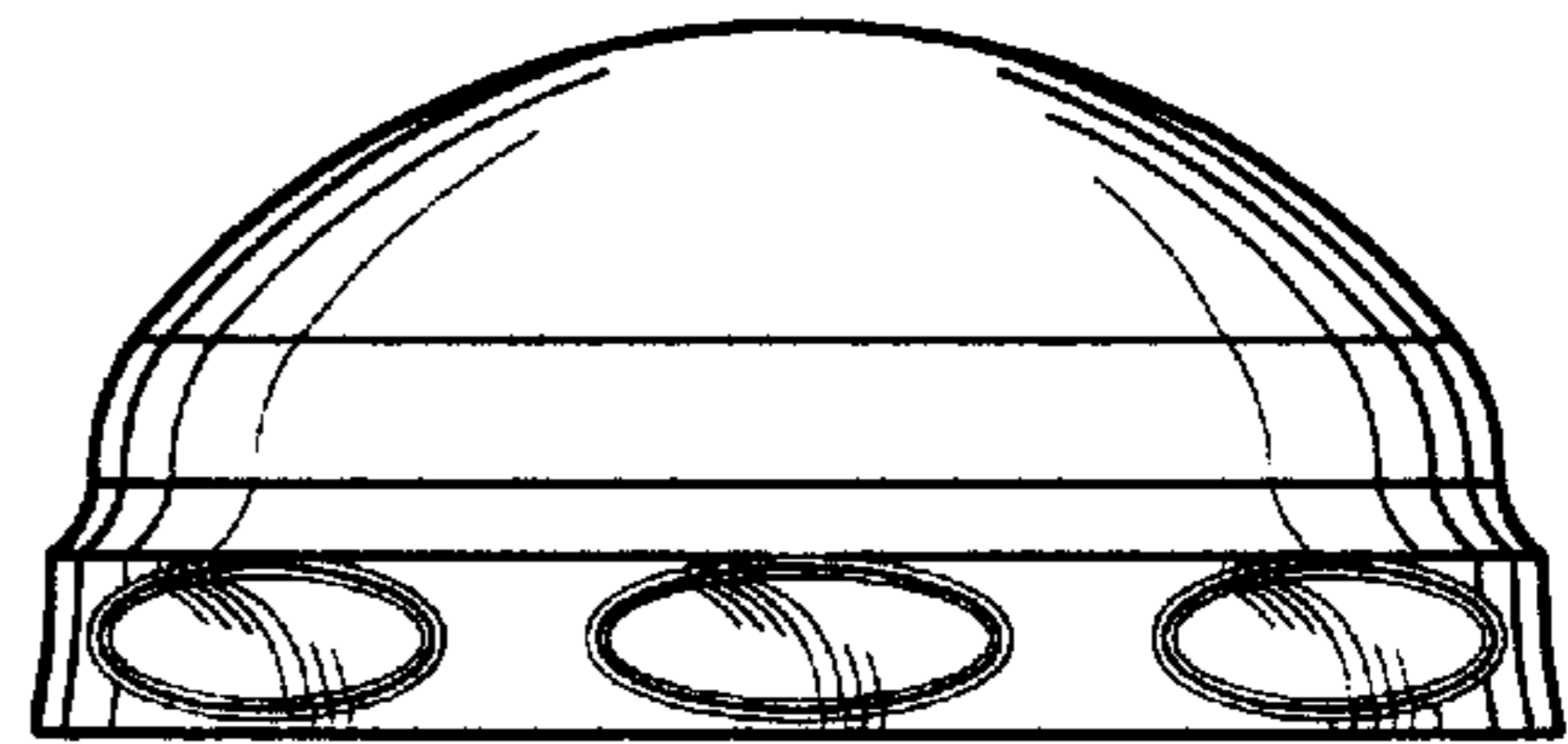

Fig-12

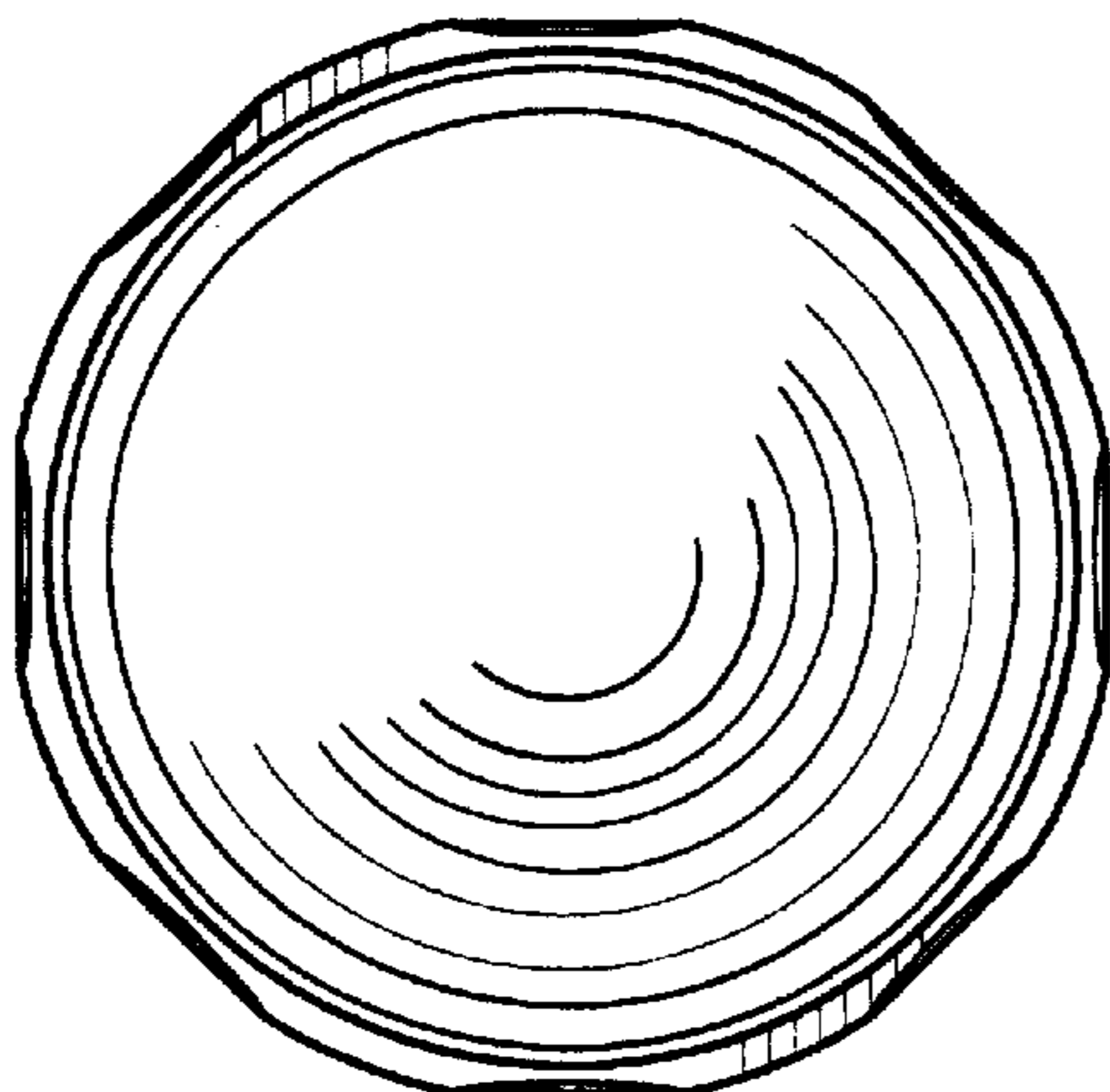

Fig-14

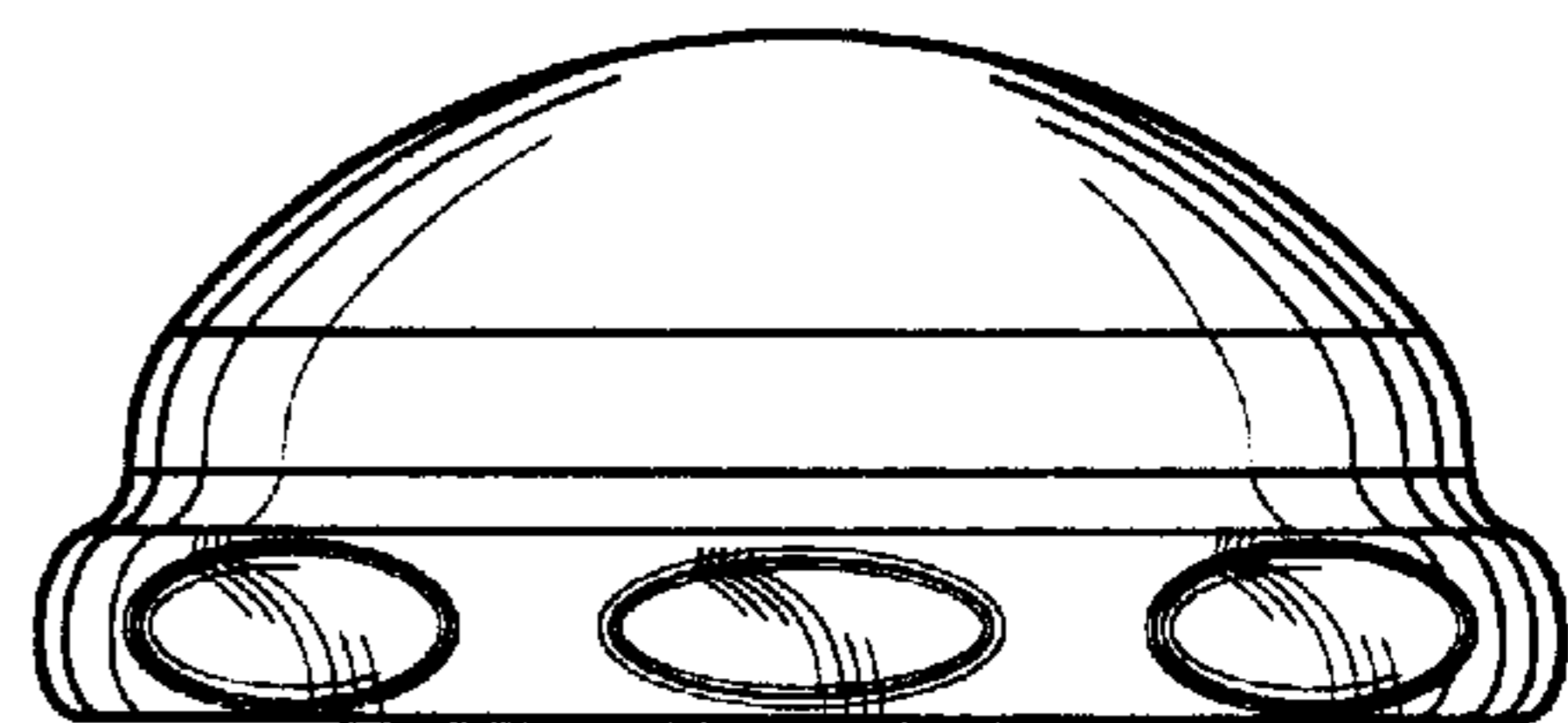

Fig-13