



US00D413112S

United States Patent [19]

Ohata et al.

[11] Patent Number: **Des. 413,112**

[45] Date of Patent: **** Aug. 24, 1999**

[54] **SCANNER MOTOR**

[75] Inventors: **Koichiro Ohata; Taehiro Matsumoto,**
both of Tottori, Japan

[73] Assignee: **Matsushita Electric Industrial Co.,**
Ltd., Japan

[**] Term: **14 Years**

[21] Appl. No.: **29/079,588**

[22] Filed: **Oct. 20, 1997**

[30] **Foreign Application Priority Data**

Apr. 24, 1997 [JP] Japan 9/052714

[51] **LOC (6) Cl.** **14-02**

[52] **U.S. Cl.** **D14/116; D13/112**

[58] **Field of Search** D14/114, 116,
D14/100, 107, 105; D13/112; 359/200,
196, 216-219; 310/90, 90.5; 384/129, 132-135;
464/170, 179

[56] **References Cited**

U.S. PATENT DOCUMENTS

- D. 360,615 7/1995 Sakashita et al. D13/112
- D. 368,069 3/1996 Sakashita et al. D13/112

- D. 389,470 1/1998 Schick et al. D14/114
- 4,953,925 9/1990 Parker 359/200
- 5,596,443 1/1997 Konno et al. 359/200
- 5,604,621 2/1997 Fujikane 359/200
- 5,708,520 1/1998 Yoshitsugu et al. 359/200

OTHER PUBLICATIONS

Sankyo DC Micro Motors, FOMLL50 series, FOMLL00 series, catalog published Oct. 1, 1994.

Primary Examiner—M. H. Tung
Attorney, Agent, or Firm—Saidman DesignLaw Group

[57] **CLAIM**

The ornamental design for a scanner motor, as shown and described.

DESCRIPTION

FIG. 1 is a perspective view of the top, front and right side of a scanner motor showing our new design; FIG. 2 is a front elevational view thereof; FIG. 3 is a rear elevational view thereof; FIG. 4 is a top plan view thereof; FIG. 5 is a right side view thereof; FIG. 6 is a left side view thereof; and, FIG. 7 is a bottom view thereof.

1 Claim, 5 Drawing Sheets

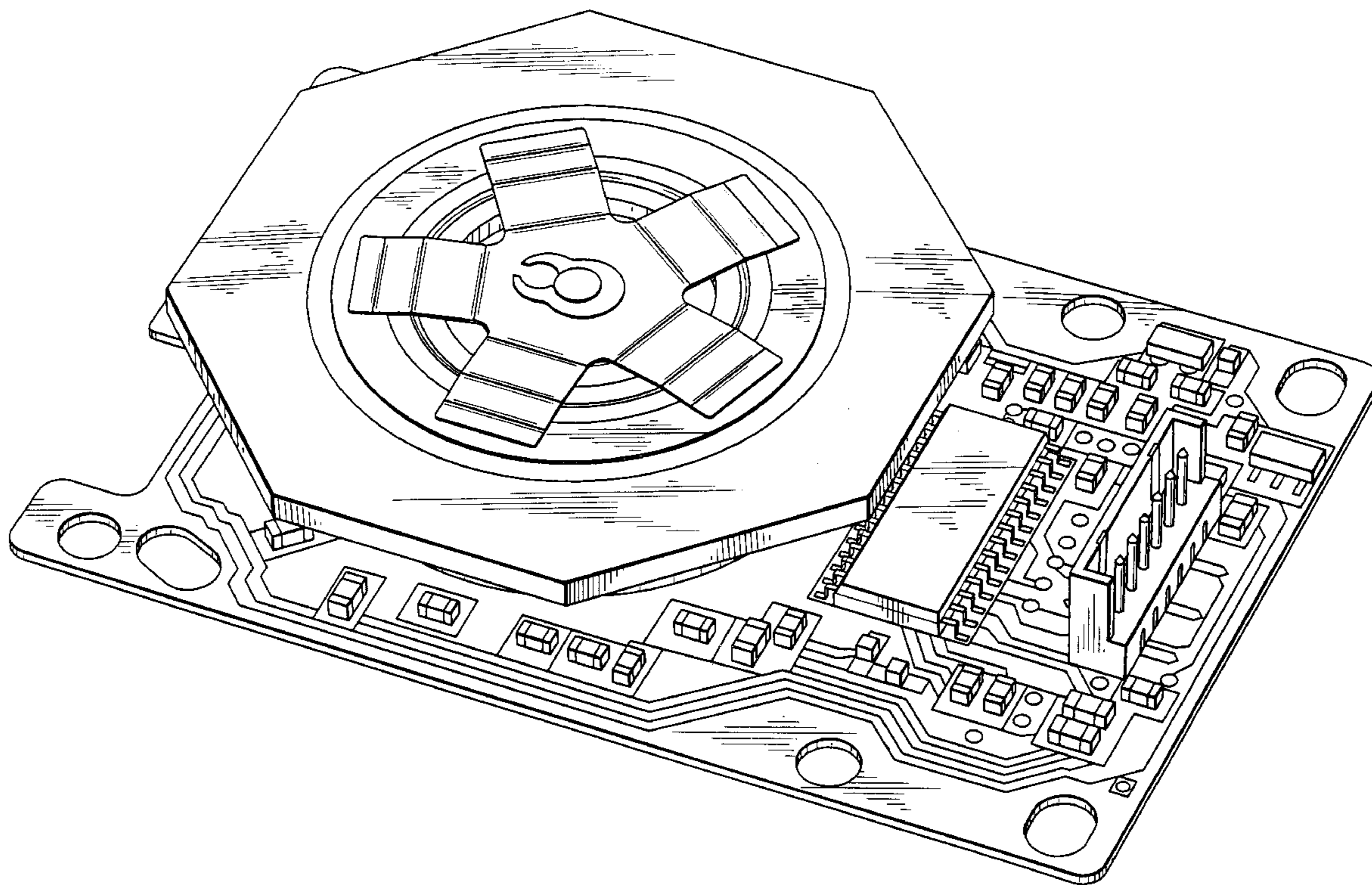

FIG. 1

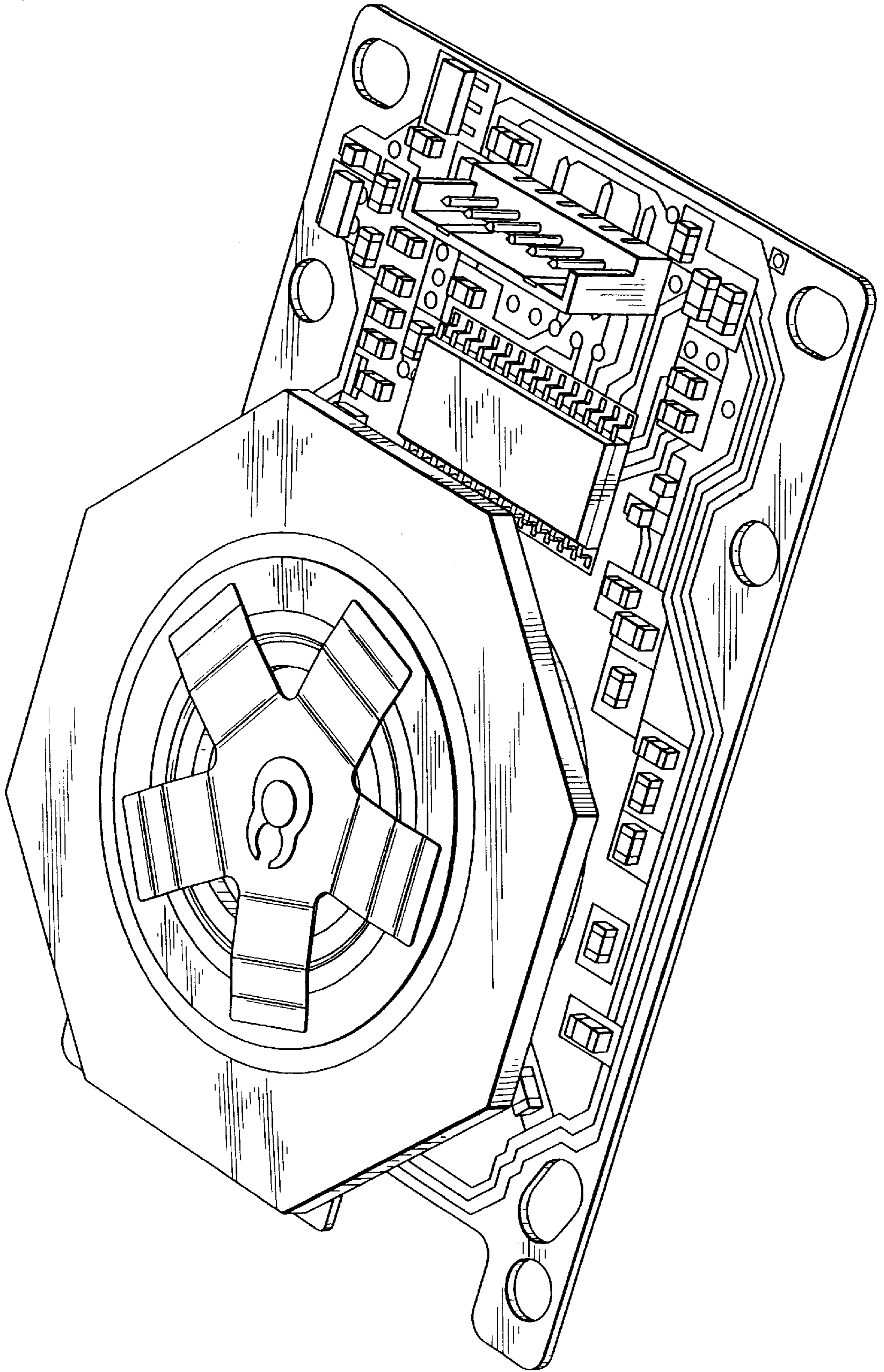

FIG. 2

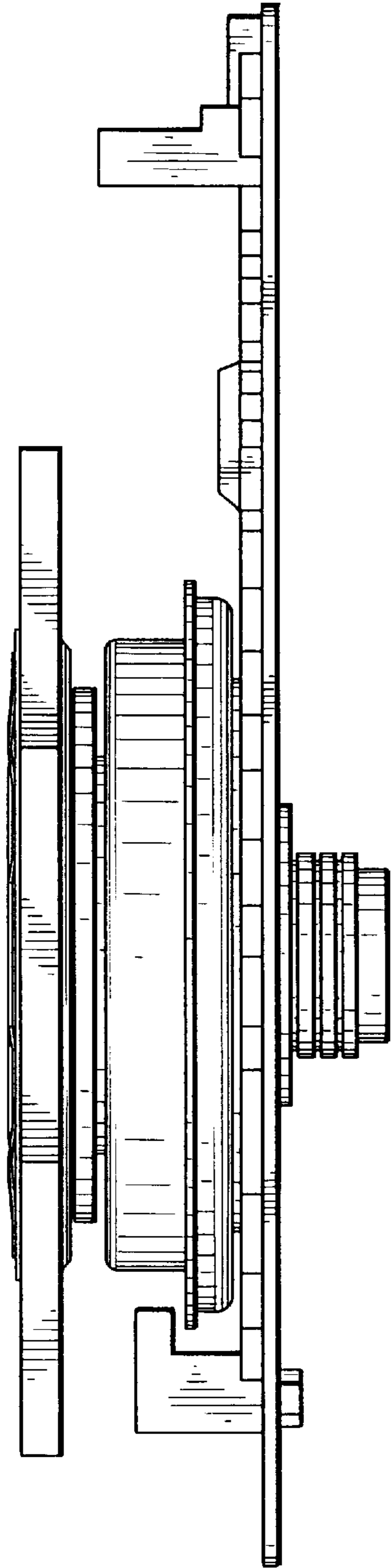

FIG. 3

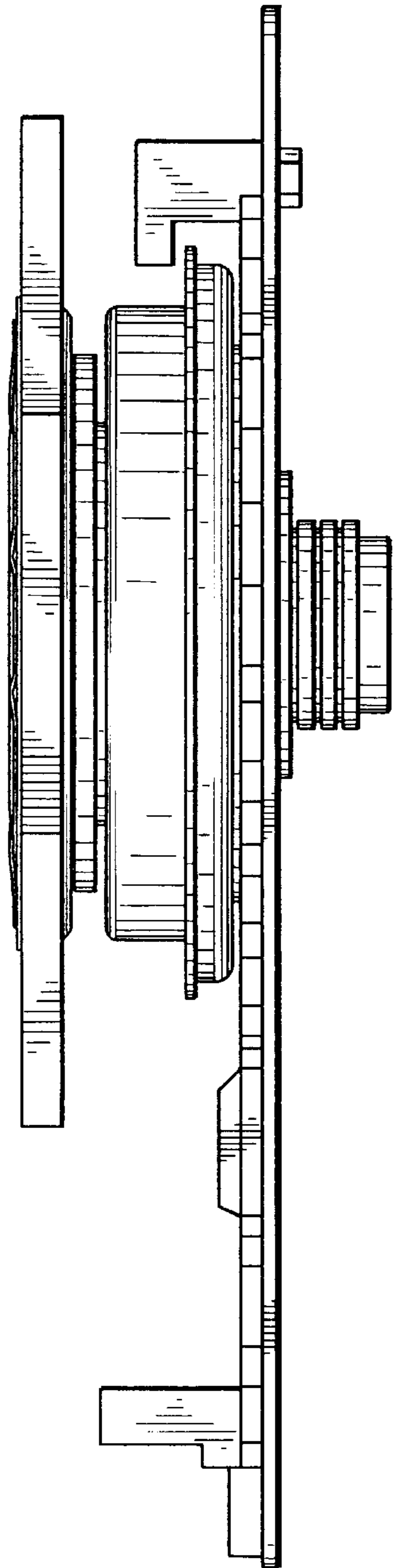

FIG. 4

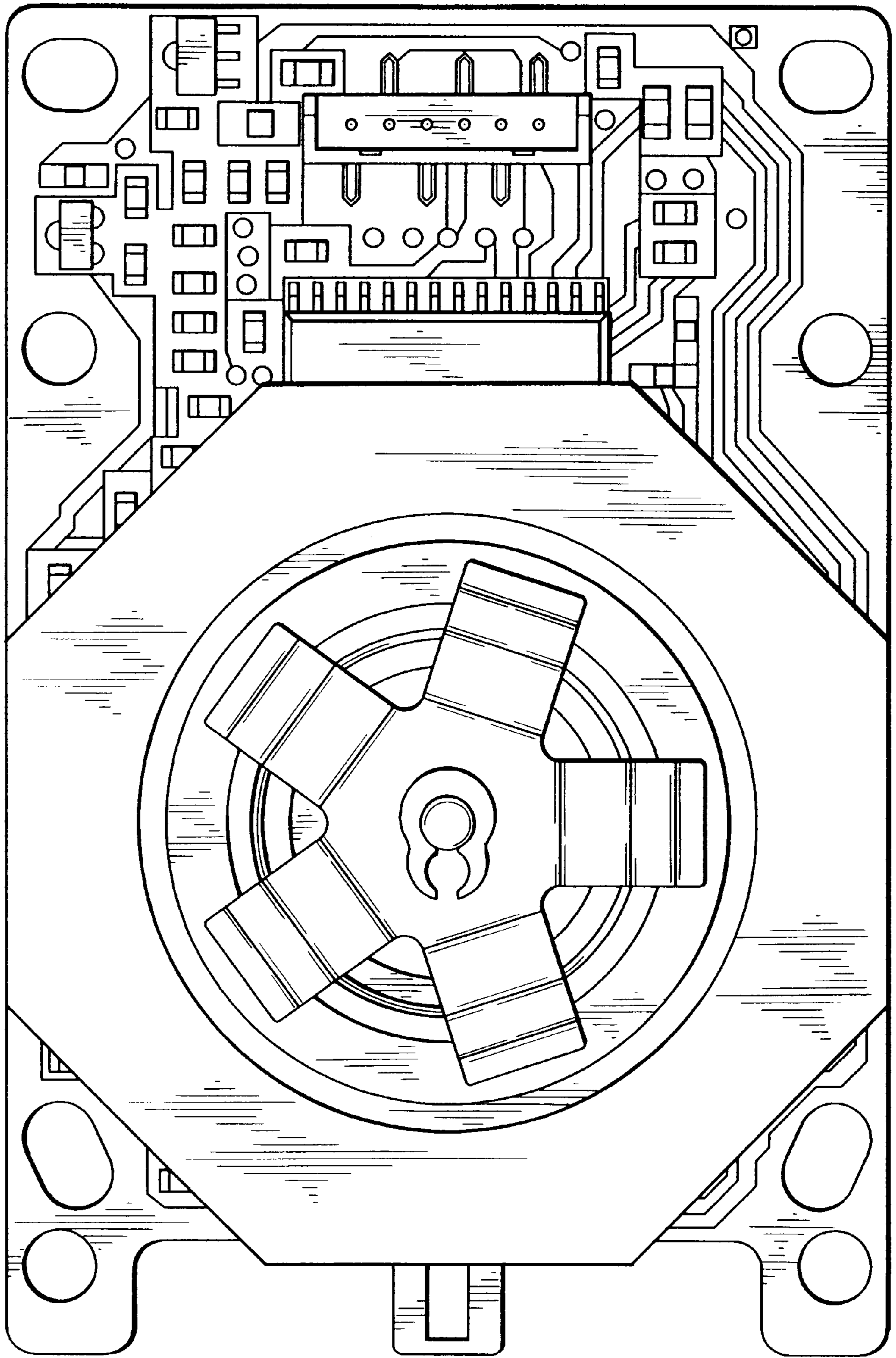

FIG. 5

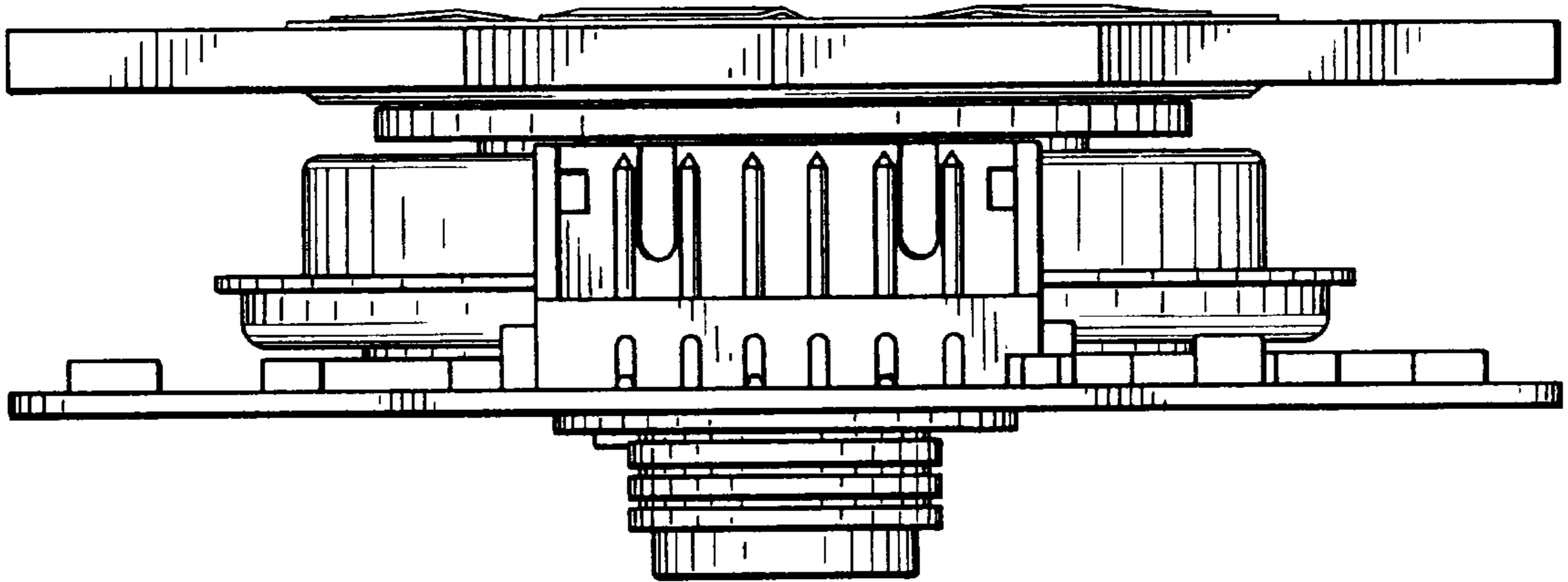

FIG. 6

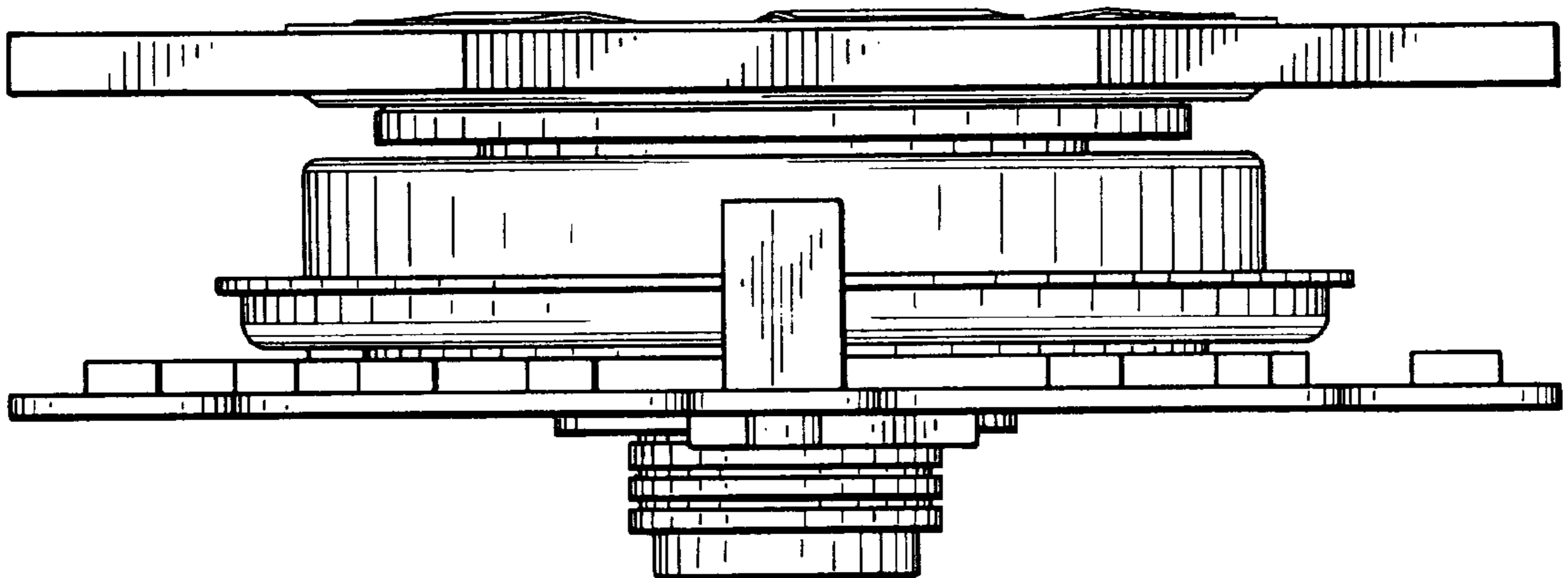

FIG. 7

