



US00D413052S

# United States Patent [19] Staton

[11] **Patent Number: Des. 413,052**

[45] **Date of Patent: \*\* Aug. 24, 1999**

[54] **LOPPING SHEAR**

[75] Inventor: **John Staton**, Bristol, Conn.

[73] Assignee: **The Stanley Works**, New Britain, Conn.

[\*\*] Term: **14 Years**

[21] Appl. No.: **29/092,235**

[22] Filed: **Aug. 14, 1998**

[51] **LOC (6) Cl.** ..... **08-01**

[52] **U.S. Cl.** ..... **D8/5**

[58] **Field of Search** ..... D8/5, 4; 30/251-252, 30/253

[56] **References Cited**

**U.S. PATENT DOCUMENTS**

- D. 320,333 10/1991 Grove ..... D8/5
- D. 344,219 2/1994 Wensley et al. .... D8/5
- D. 357,390 4/1995 Thompson et al. .... D8/5

**OTHER PUBLICATIONS**

Union Fork and Hoe catalog, p. 43 lopper shears—item 11 located at right of page, Dec. 1986.

*Primary Examiner*—Holly Baynham  
*Attorney, Agent, or Firm*—Pillsbury Madison & Sutro LLP

[57] **CLAIM**

The ornamental design for a lopping shear, as shown and described.

**DESCRIPTION**

FIG. 1 is a perspective view of a lopping shear showing my new design, looking downwardly at the front right side thereof;

FIG. 2 is a right side elevational view thereof;

FIG. 3 is a top plan view thereof;

FIG. 4 is a left side elevational view thereof;

FIG. 5 is a bottom plan view thereof;

FIG. 6 is a front view thereof; and,

FIG. 7 is a rear view thereof.

**1 Claim, 5 Drawing Sheets**

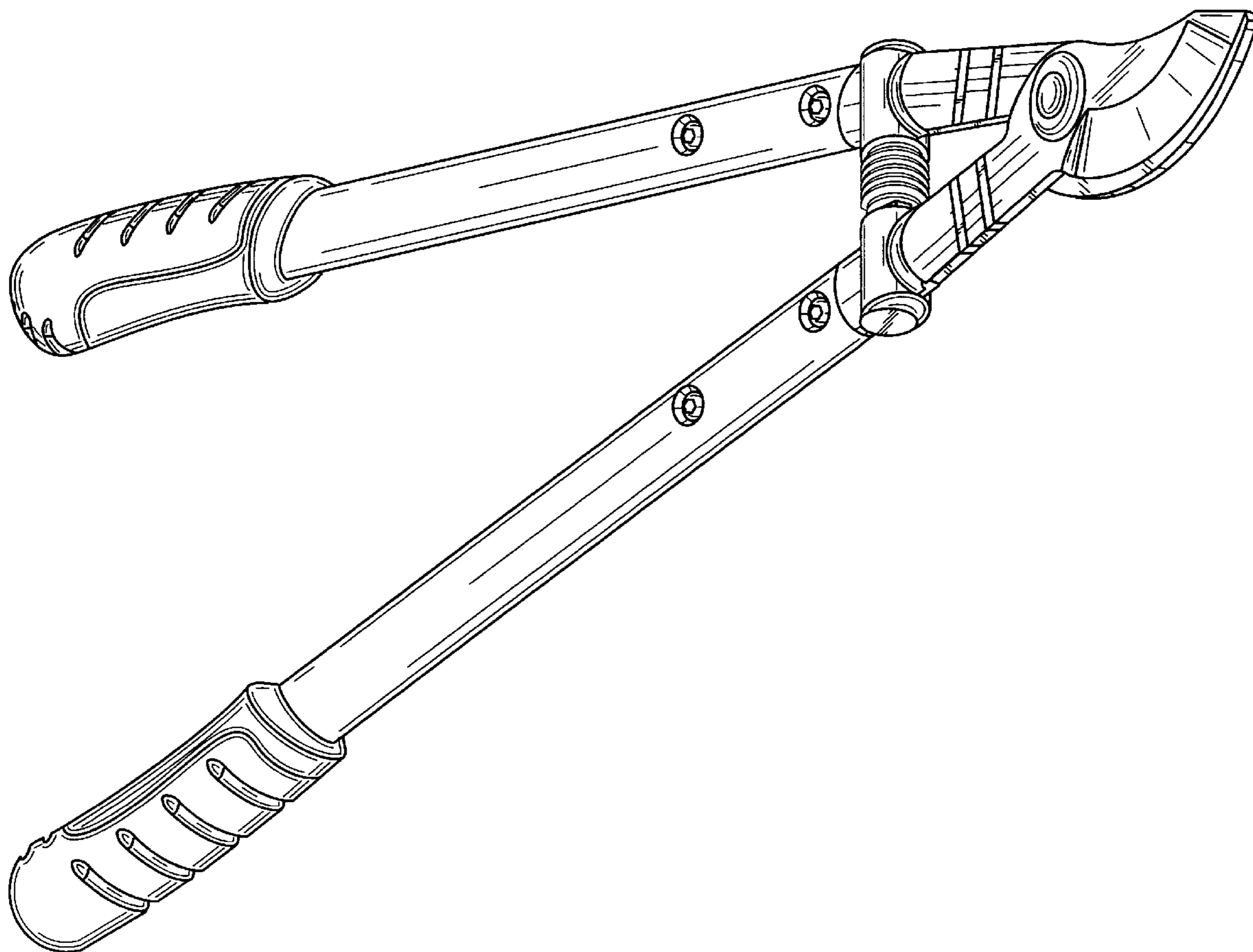

FIG. 1

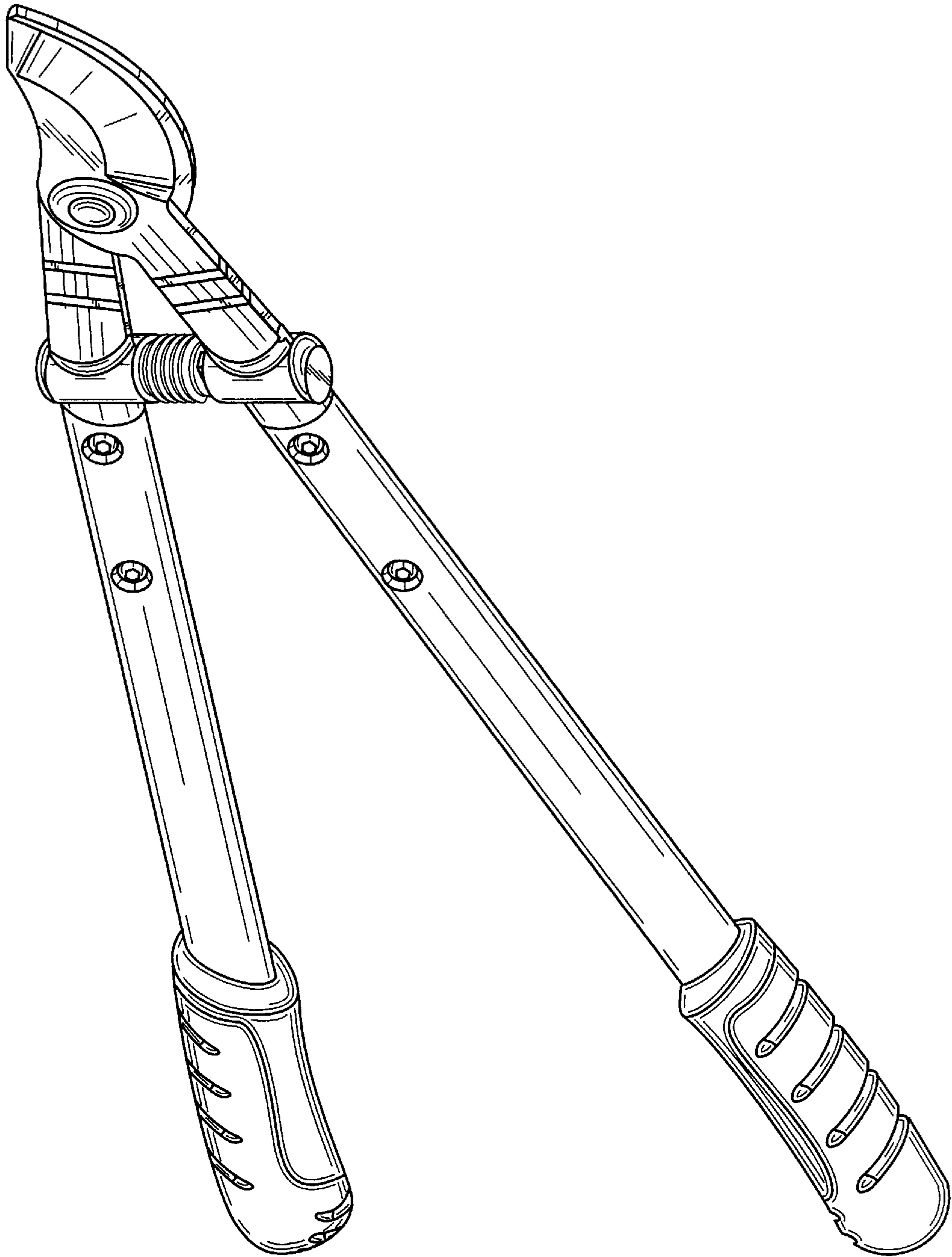

FIG. 2

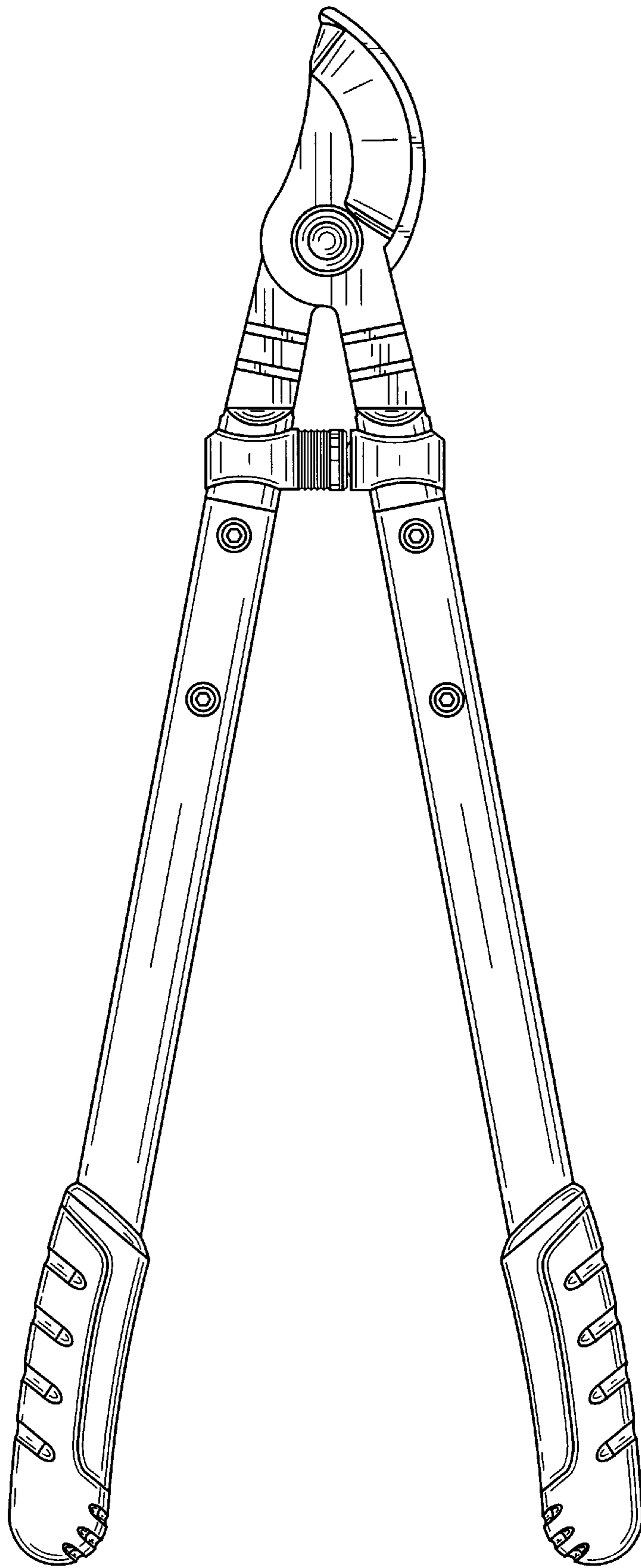

FIG. 3

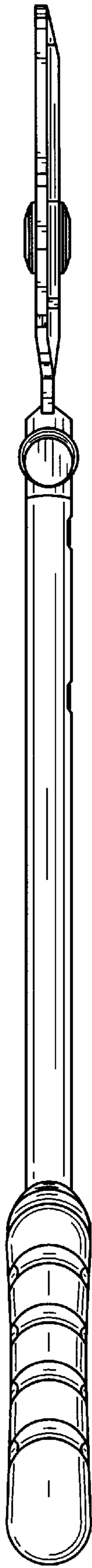

FIG. 5

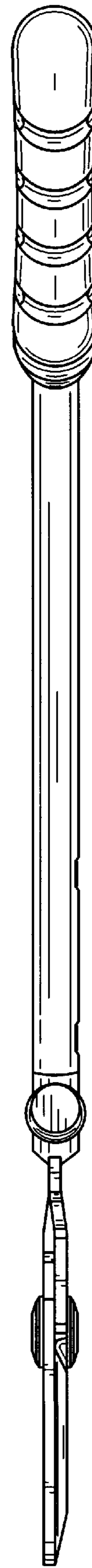

FIG. 4

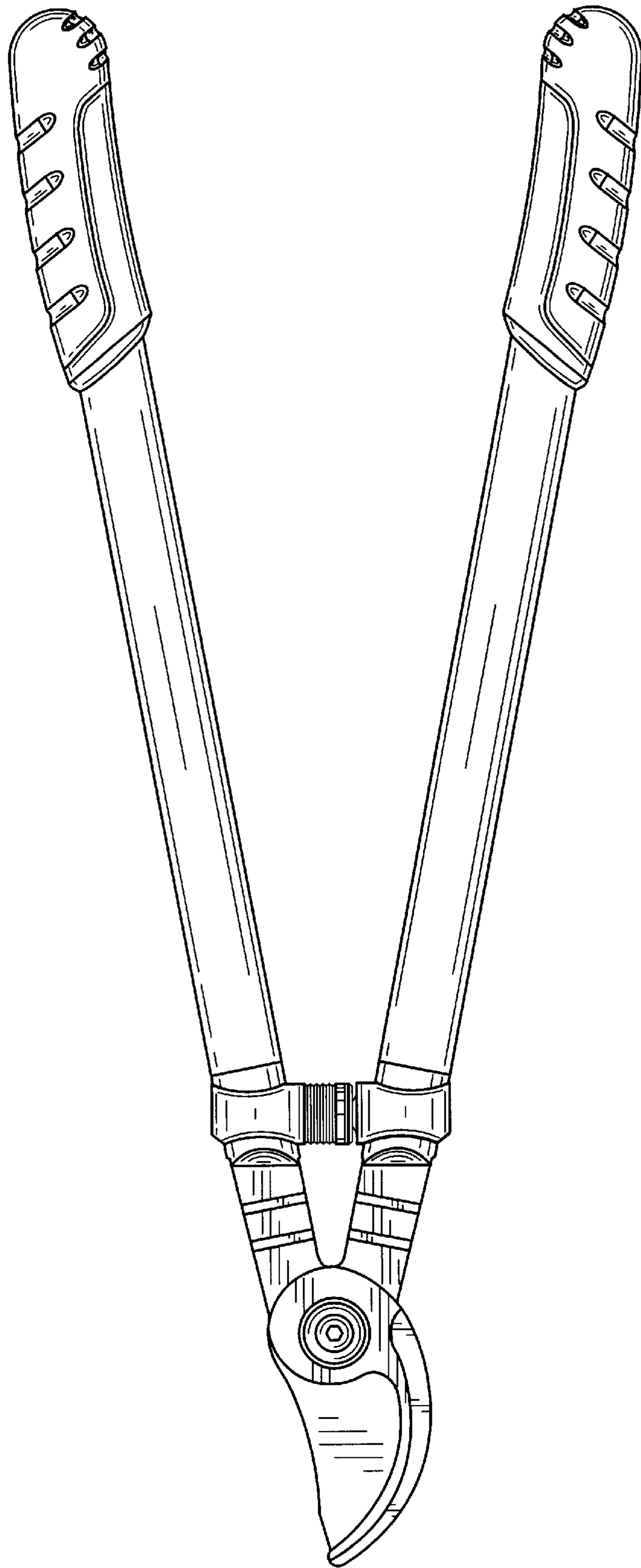

FIG. 7

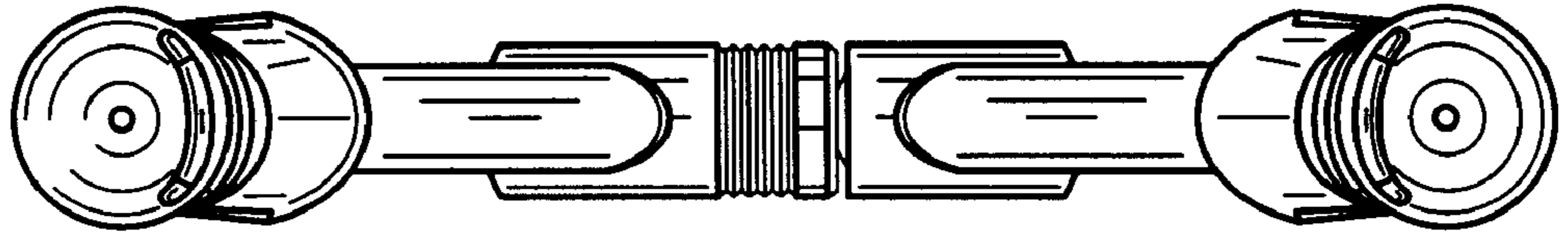

FIG. 6

