



US00D413022S

# United States Patent [19]

Tyneski et al.

[11] Patent Number: Des. 413,022

[45] Date of Patent: \*\* Aug. 24, 1999

[54] **HOLSTER CLIP FOR A PORTABLE COMMUNICATIONS DEVICE**

[75] Inventors: **Frank M. Tyneski**, Ft. Lauderdale;  
**William H. Robertson, Jr.**, Plantation,  
both of Fla.

[73] Assignee: **Motorola, Inc.**, Schaumburg, Ill.

[\*\*] Term: **14 Years**

[21] Appl. No.: **29/090,658**

[22] Filed: **Jul. 14, 1998**

[51] **LOC (6) Cl.** ..... **03-01**

[52] **U.S. Cl.** ..... **D3/328**

[58] **Field of Search** ..... D14/142, 251,  
D14/253; D3/218, 328; 379/440, 419, 428,  
441, 446, 450, 455, 454; 455/90, 128, 575;  
D13/108; 224/269, 904, 240, 236

## [56] References Cited

### U.S. PATENT DOCUMENTS

- D. 111,573 10/1938 Scharfenberg .
- D. 121,478 7/1940 Loewy .
- D. 162,882 4/1951 Rodgers-Bannister ..... D26/14
- D. 167,828 9/1952 Florac ..... D56/4
- D. 187,074 1/1960 Cunningham ..... D16/14
- D. 214,579 7/1969 Hanhart ..... D10/2
- D. 249,682 9/1978 Kushida et al. .... D14/1
- D. 251,910 5/1979 Taguchi ..... D14/3
- D. 284,454 7/1986 Gremunprez et al. .... D10/40
- D. 286,453 10/1986 Camens ..... D28/49
- D. 287,853 1/1987 Siegel ..... D14/70
- D. 288,299 2/1987 Mark ..... D10/40
- D. 290,957 7/1987 Imazeki ..... D14/68
- D. 295,511 5/1988 Schied et al. .... D13/8
- D. 299,664 1/1989 Ferguson et al. .... D21/111
- D. 328,157 7/1992 Lazarchik et al. .... D28/49
- D. 330,907 11/1992 Burke ..... D18/7

- D. 337,952 8/1993 Wolff ..... D10/30
- D. 339,848 9/1993 Hebblewhite et al. .... D14/253
- D. 342,739 12/1993 Atkin et al. .... D14/217
- D. 344,943 3/1994 Kajita et al. .... D14/138
- D. 346,382 4/1994 Ando et al. .... D14/138
- D. 348,775 7/1994 Scheid ..... D3/328
- D. 350,153 8/1994 Jabbar ..... D19/20
- D. 353,783 12/1994 Burns ..... D10/101
- D. 356,065 3/1995 Alexandres et al. .... D13/103
- D. 358,822 5/1995 Rudkiewicz et al. .... D14/253
- D. 364,164 11/1995 Hanig ..... D14/192
- D. 374,188 10/1996 Horii ..... D10/104
- D. 375,097 10/1996 Kovens ..... D14/159
- D. 377,351 1/1997 Toki et al. .... D14/138
- D. 378,816 4/1997 Hino ..... D14/138
- D. 387,758 12/1997 Oross et al. .... D14/137
- D. 389,139 1/1998 Oross et al. .... D14/137
- D. 389,158 1/1998 Oross ..... D14/250
- D. 389,827 1/1998 Oross et al. .... D14/137
- 5,109,539 4/1992 Inubushi et al. .... 455/89
- 5,197,091 3/1993 Takagi et al. .

*Primary Examiner*—Louis S. Zarfaz  
*Assistant Examiner*—Robert Delehanty  
*Attorney, Agent, or Firm*—Frank M. Scutch, III

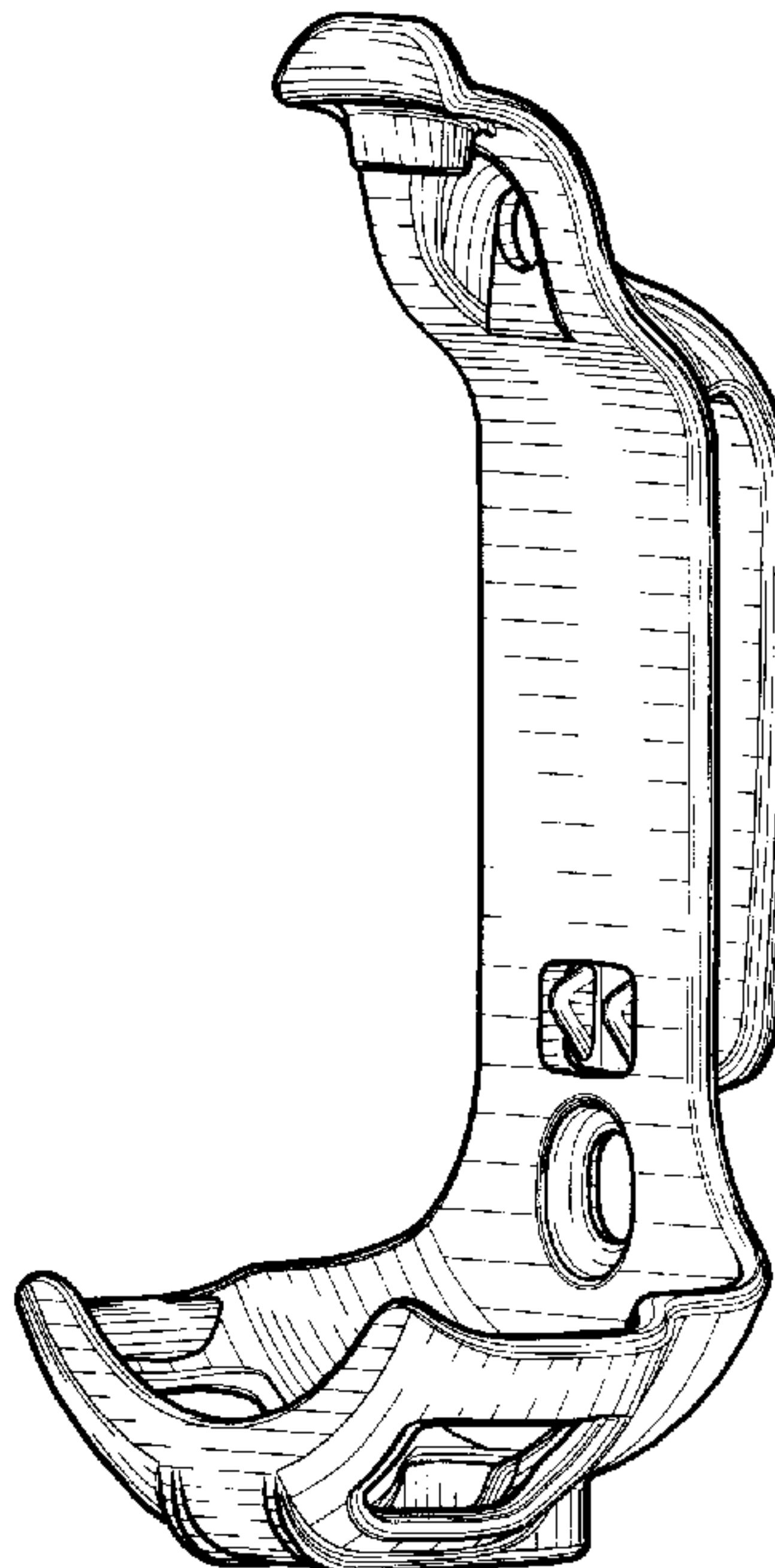
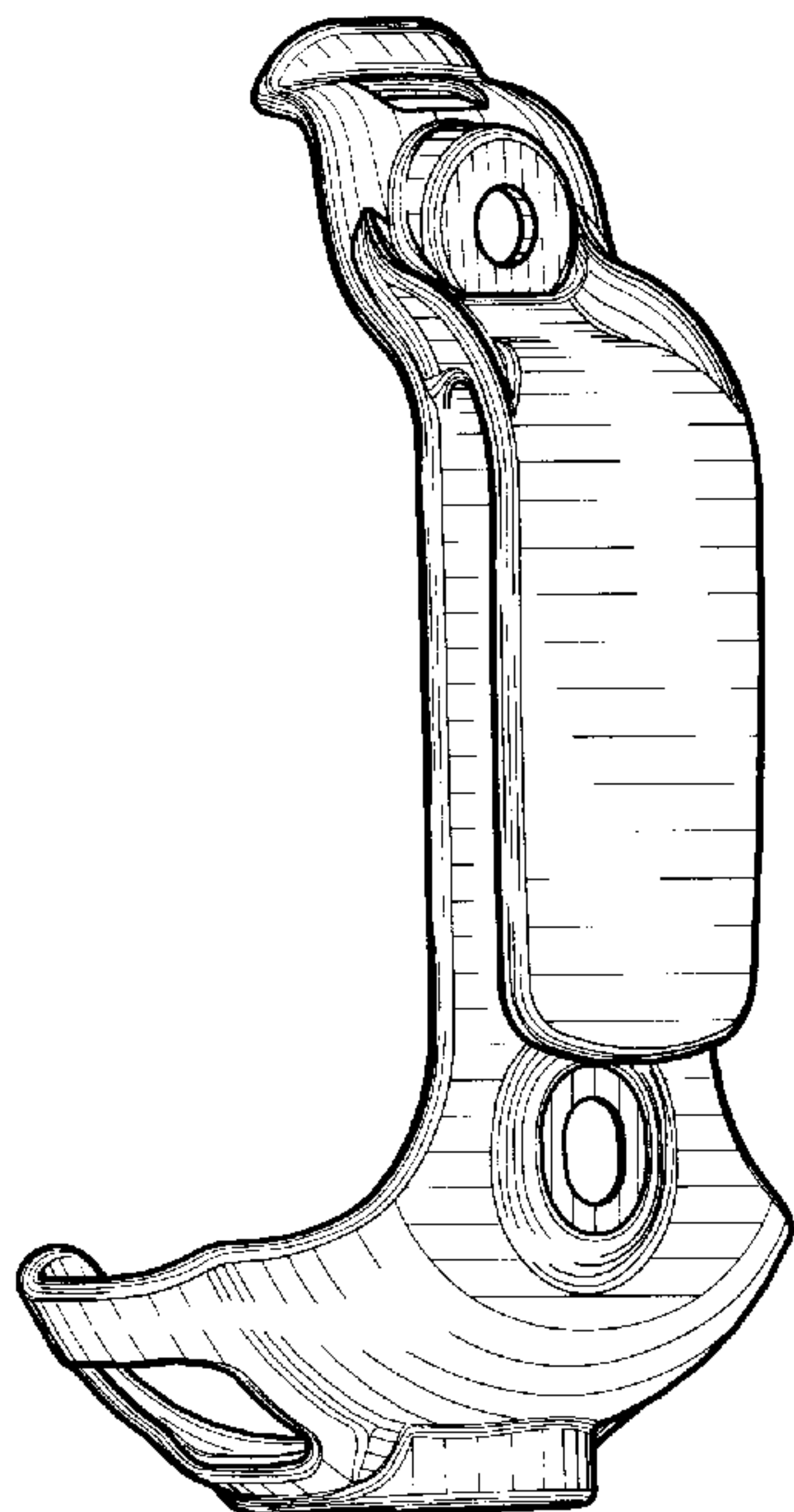
## [57] CLAIM

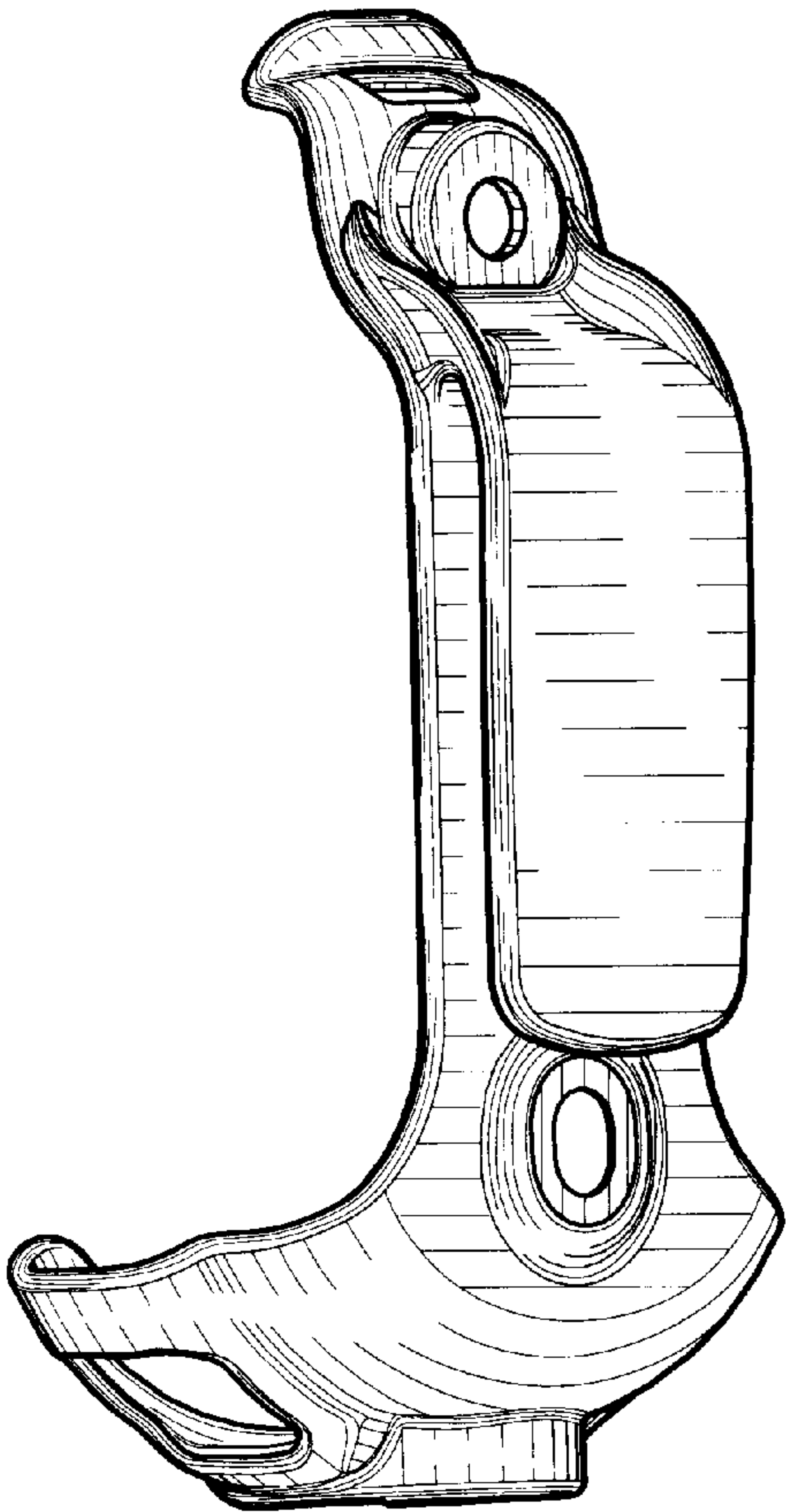
The ornamental design for a holster clip for a portable communications device, as shown and described.

## DESCRIPTION

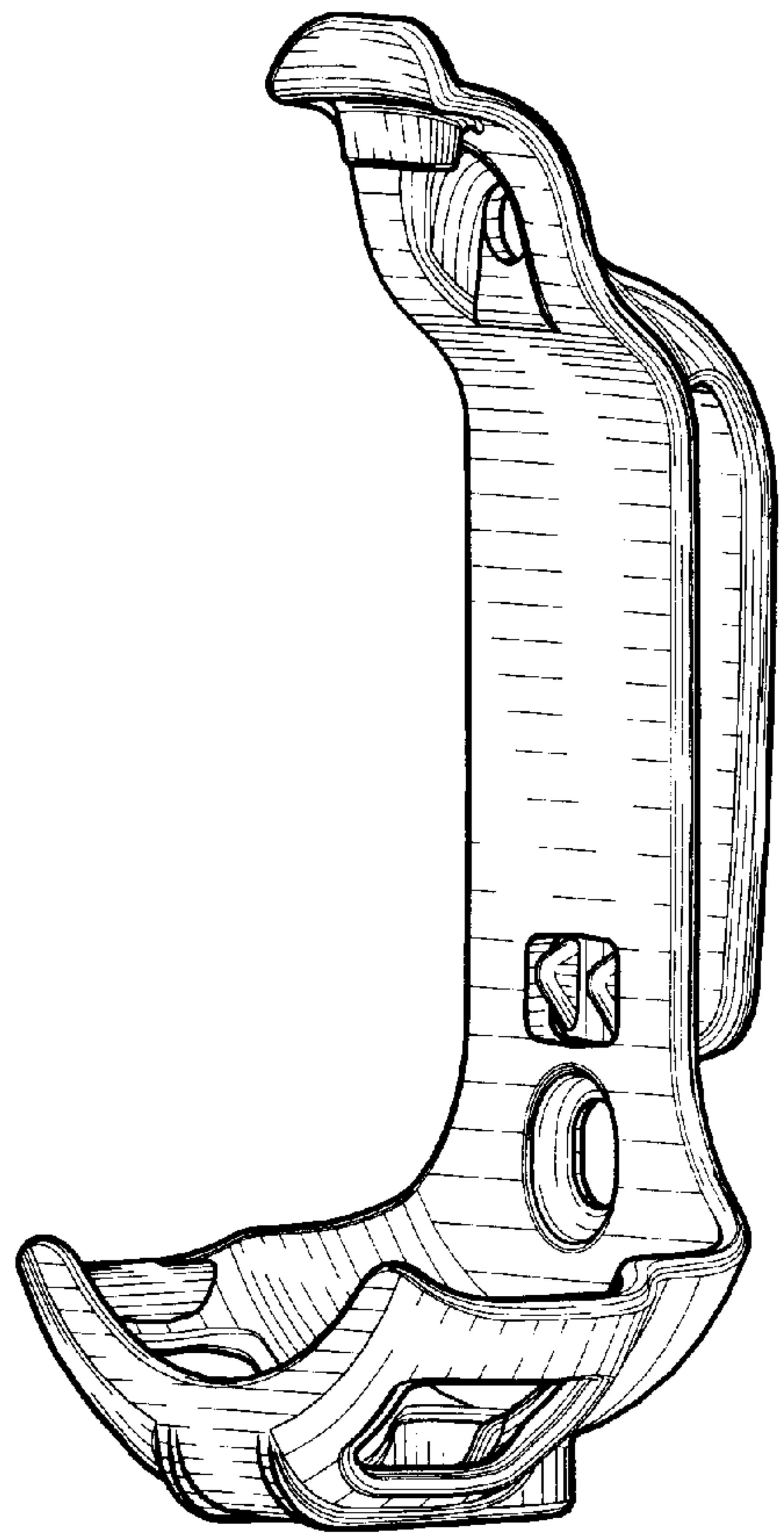
FIGS. 1 and 2 are isometric views of a holster clip for a portable communications device showing our new design; FIG. 3 is a left side view thereof; FIG. 4 is a right side view thereof; FIG. 5 is a front elevational view thereof; FIG. 6 is a rear elevational view thereof; FIG. 7 is a top plan view thereof; and, FIG. 8 is a bottom plan view thereof.

1 Claim, 4 Drawing Sheets

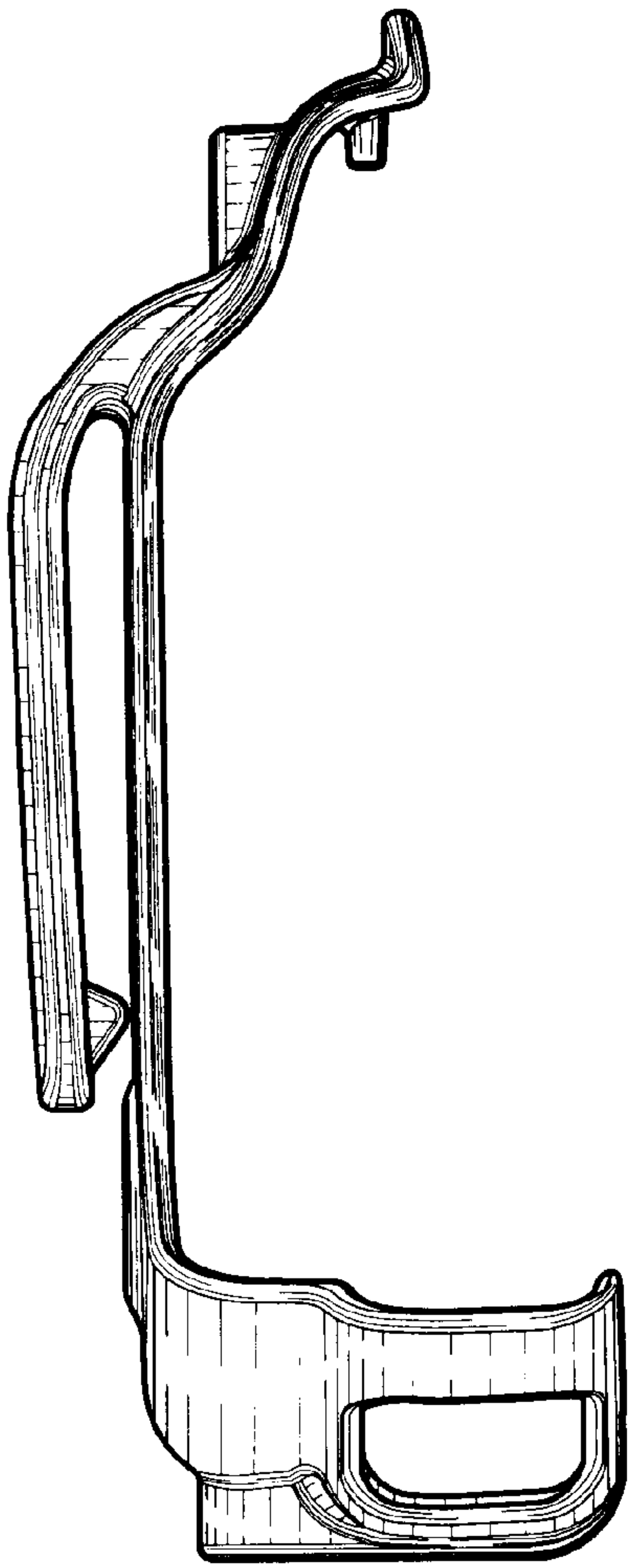




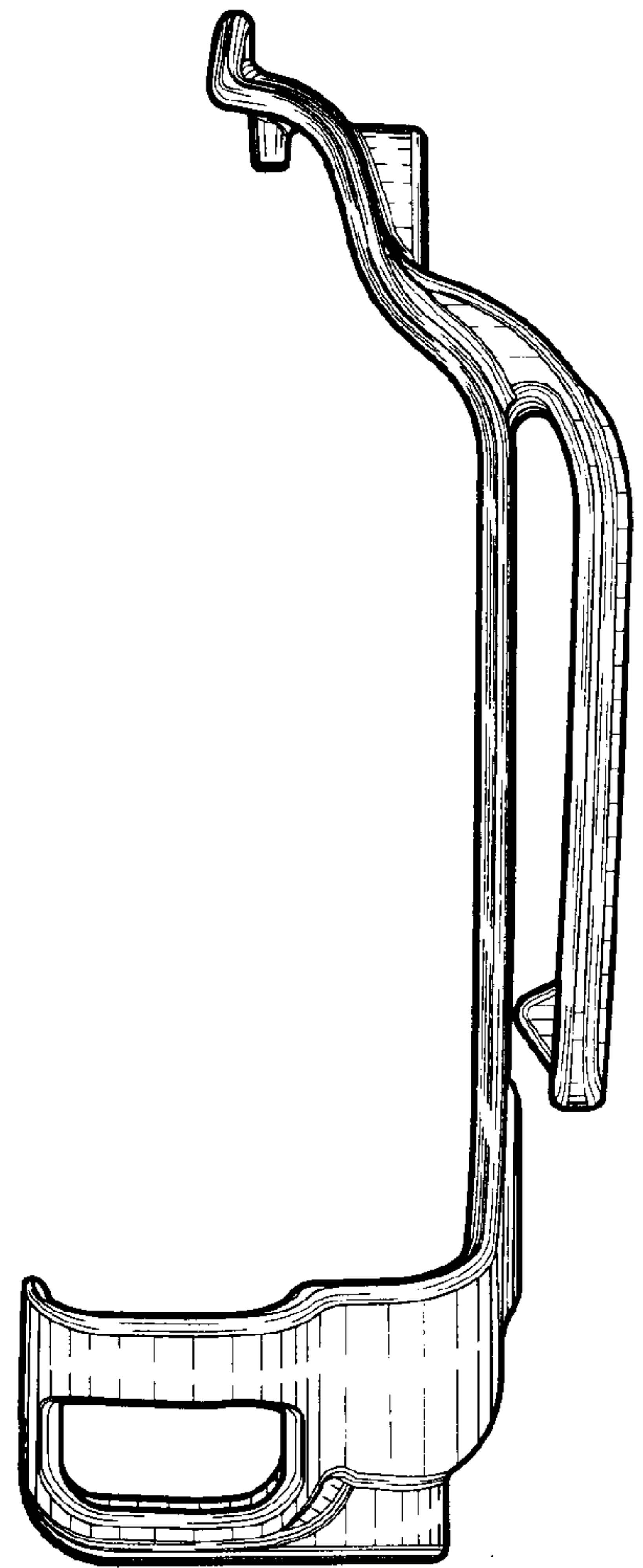
***FIG. 1***



***FIG. 2***

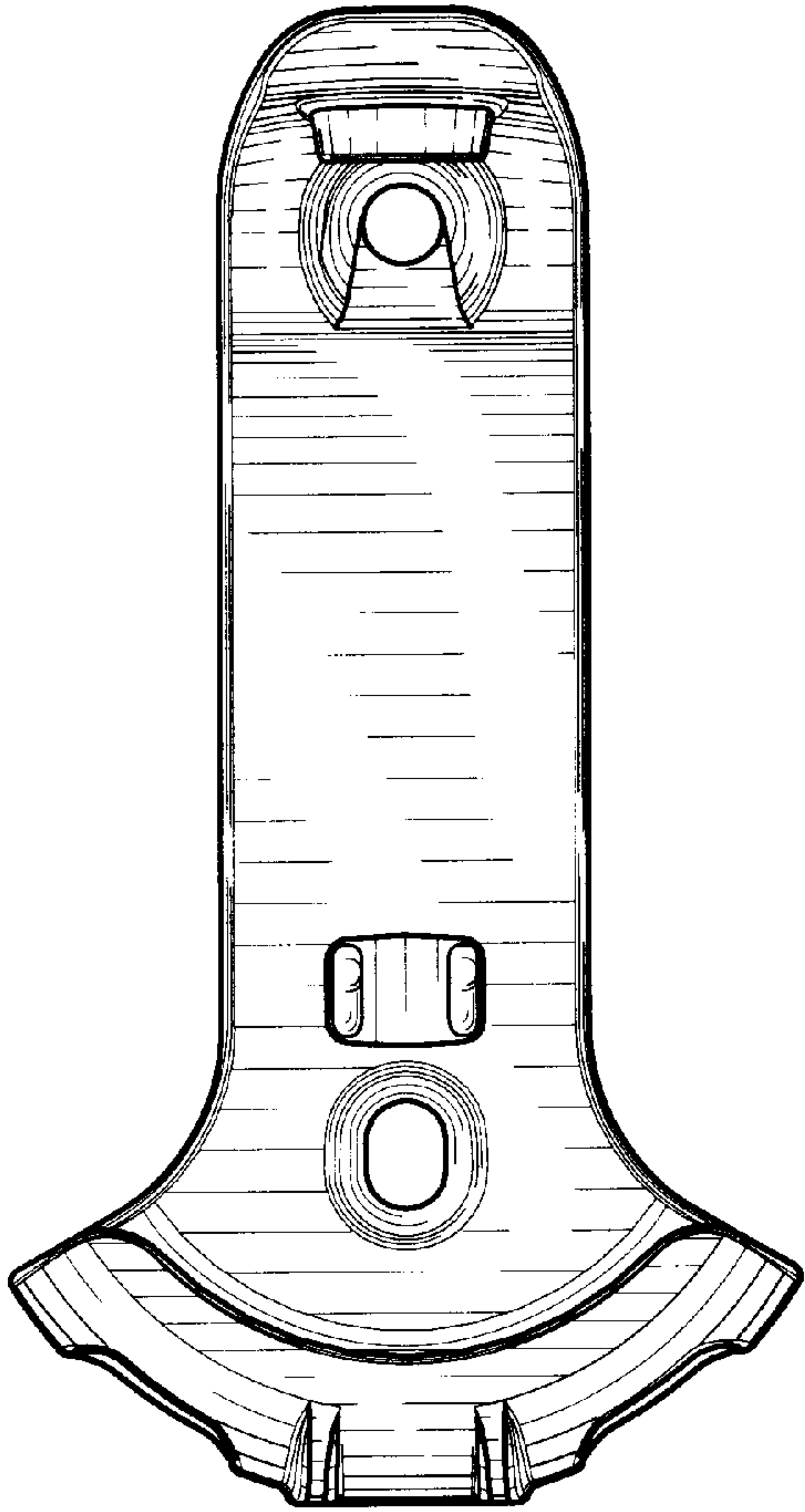


***FIG. 3***

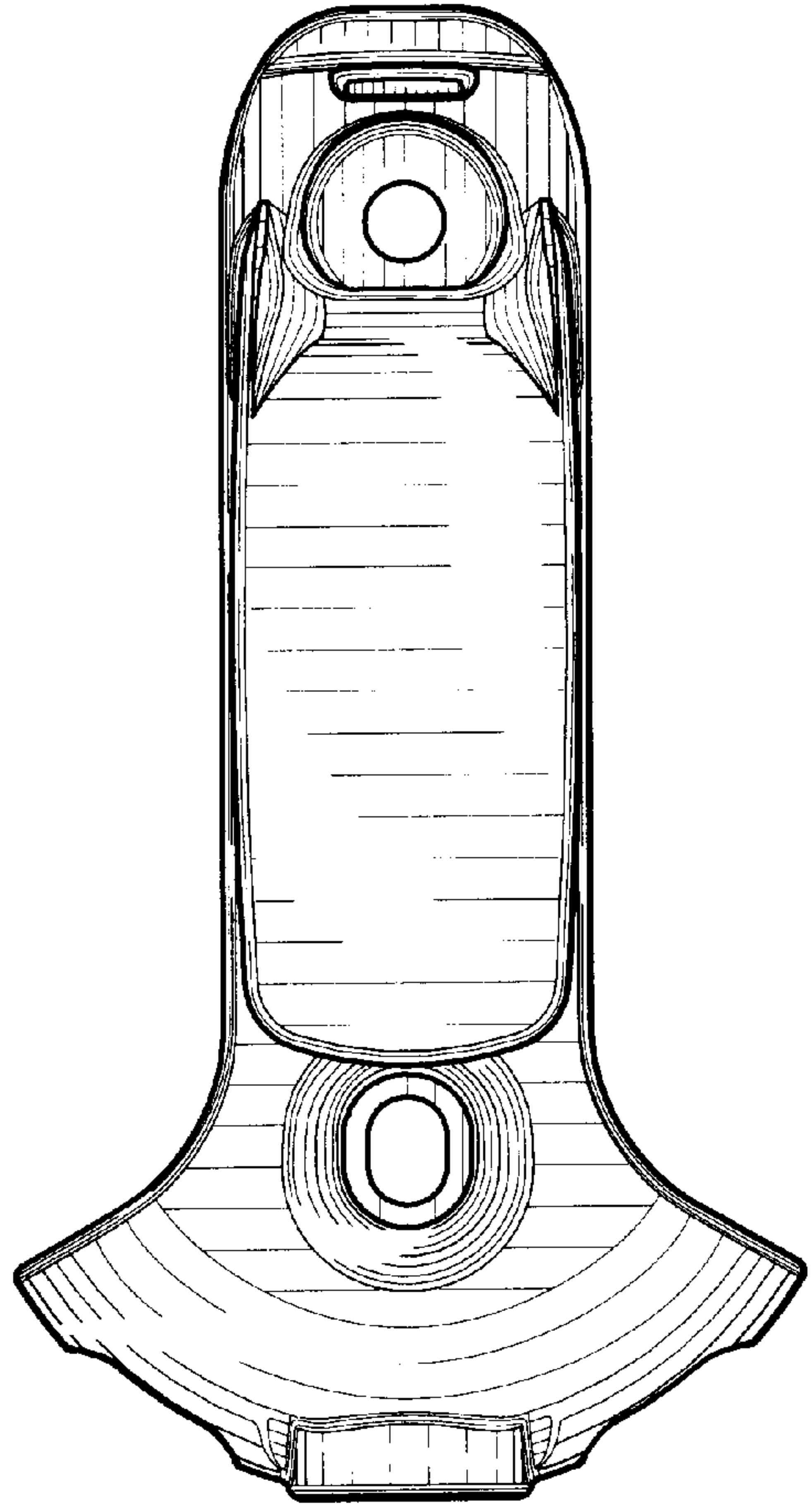


***FIG. 4***

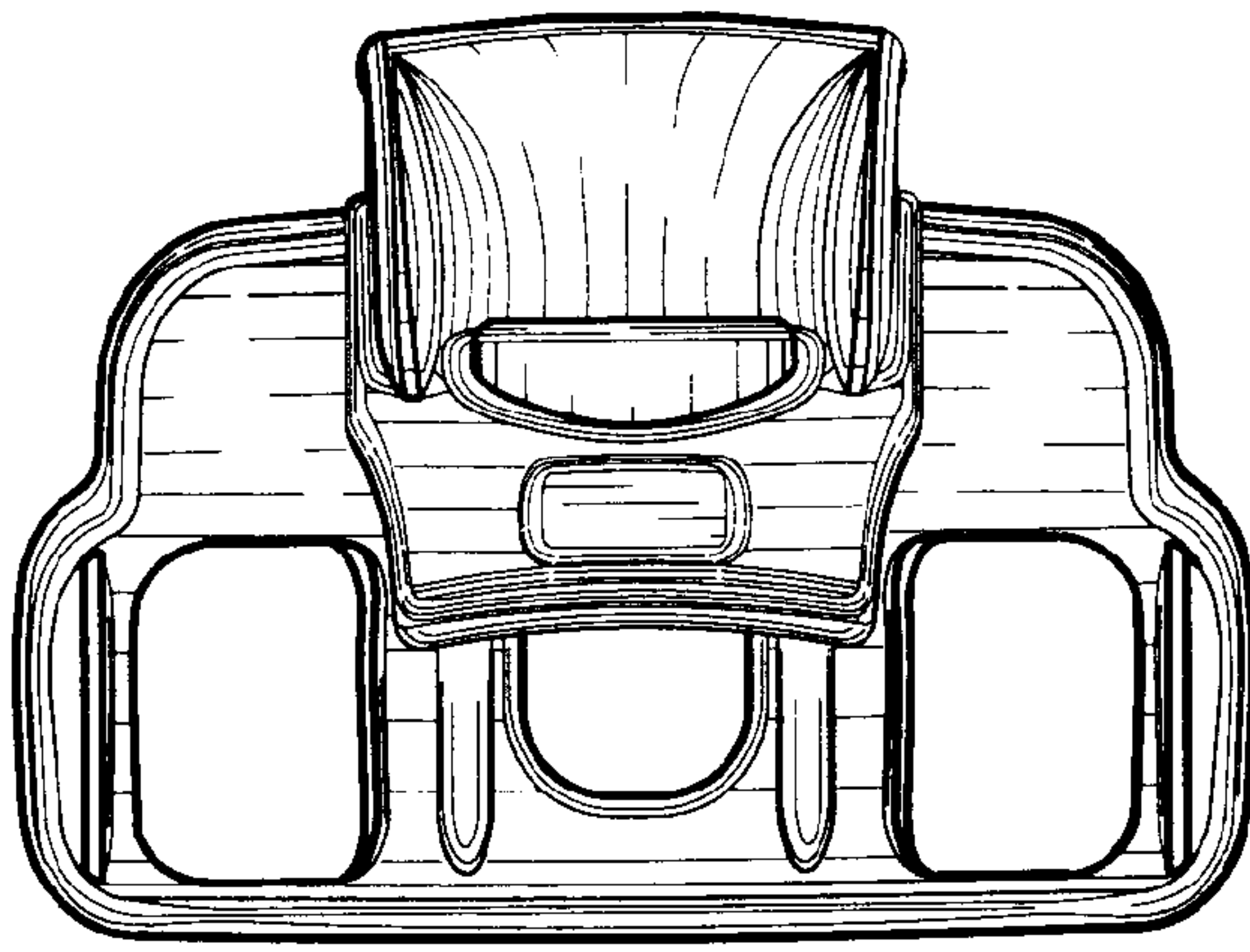




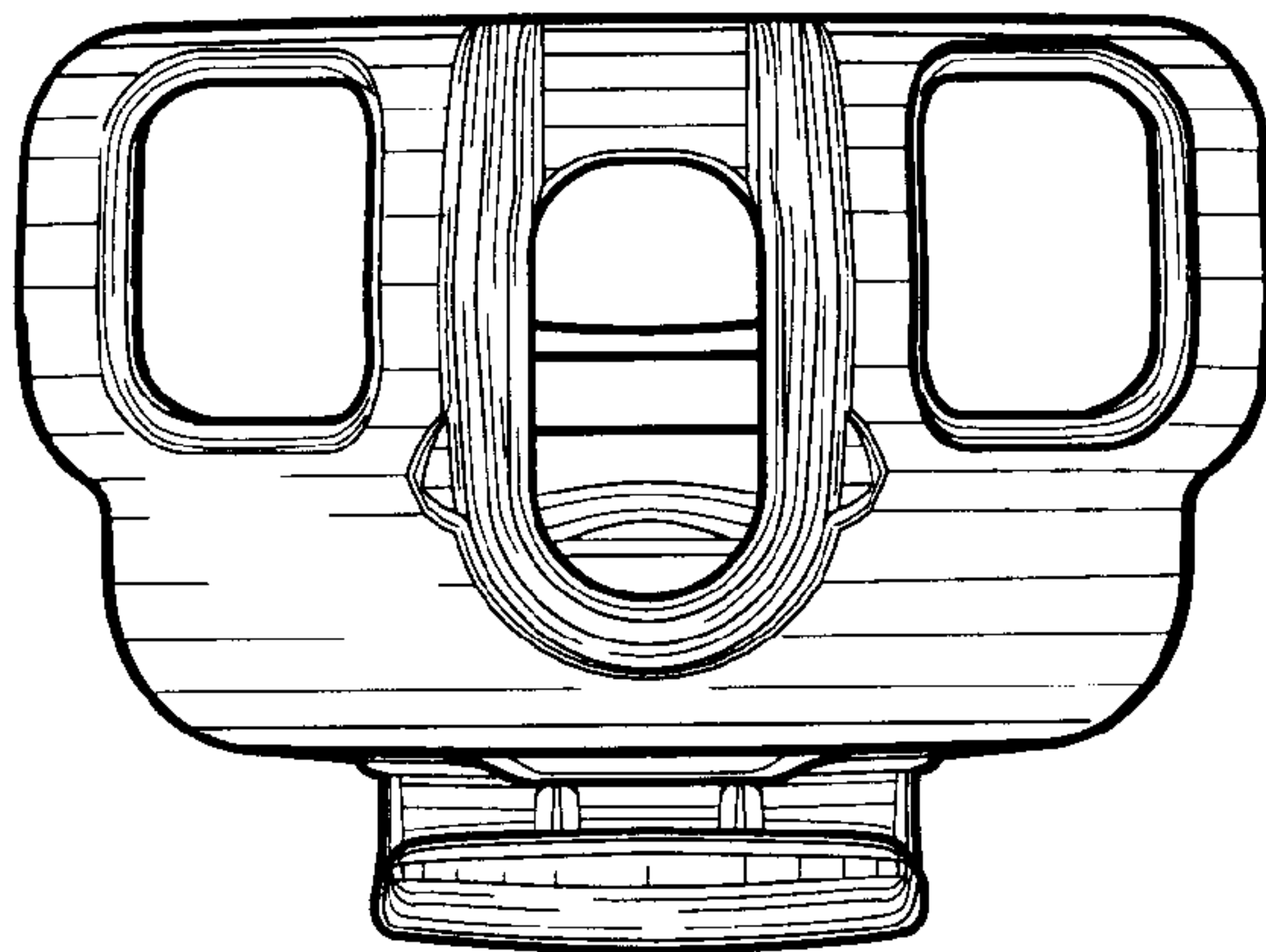
***FIG. 5***



***FIG. 6***



***FIG. 7***



***FIG. 8***