



US00D413018S

United States Patent [19]

[11] Patent Number: Des. 413,018

Boldig et al.

[45] Date of Patent: ** Aug. 24, 1999

[54] GOLF BAG WITH REMOVABLE PARTITIONED LINER

[75] Inventors: **Thomas G. Boldig**, Muskego;
Jacqueline A. Lacey, Mukwonago,
both of Wis.

[73] Assignee: **Ajay Leisure Products, Inc.**, Wis.

[**] Term: **14 Years**

[21] Appl. No.: **29/079,517**

[22] Filed: **Nov. 18, 1997**

[51] LOC (6) Cl. **03-01**

[52] U.S. Cl. **D3/255**

[58] Field of Search D3/254, 255, 259,
D3/320; 206/315.2, 315.3, 315.4, 315.5,
315.6, 315.7, 315.8; 211/70.2; 248/96

[56] References Cited

U.S. PATENT DOCUMENTS

D. 382,707	8/1997	Wang	D3/255
D. 386,303	11/1997	Wang	D3/255
D. 389,311	1/1998	Wang	D3/320
5,176,253	1/1993	Perrin et al.	206/315.5
5,566,825	10/1996	Price	206/315.5

OTHER PUBLICATIONS

Competitive Edge Golf, *Bullet Easy-Roller*, p. 18, Spring 1994, Sep. 23, 1998.

Primary Examiner—Louis S. Zarfes
Assistant Examiner—Catherine R. Oliver
Attorney, Agent, or Firm—Tung & Associates

[57] CLAIM

The ornamental design for the golf bag with removable partitioned liner, as shown and described.

DESCRIPTION

FIG. 1 is an exploded, perspective view of the golf bag and the liner with the individual pockets.

FIG. 2 is a front view of the liner.

FIG. 3 is a top view of the liner.

FIG. 4 is a side view of the liner.

FIG. 5 is a bottom view of the liner.

FIG. 6 is a rear view of the liner.

FIG. 7 is a perspective view of the golf bag with the liner inserted therein.

FIG. 8 is a front view of the golf bag with the liner inserted therein.

FIG. 9 is a side view of the golf bag with the liner inserted therein.

FIG. 10 is the rear view of the golf bag with the liner inserted therein.

FIG. 11 is a side view of the golf bag with the liner inserted therein.

FIG. 12 is a top view of the golf bag with the liner inserted therein; and,

FIG. 13 is a bottom view of the golf bag.

1 Claim, 6 Drawing Sheets

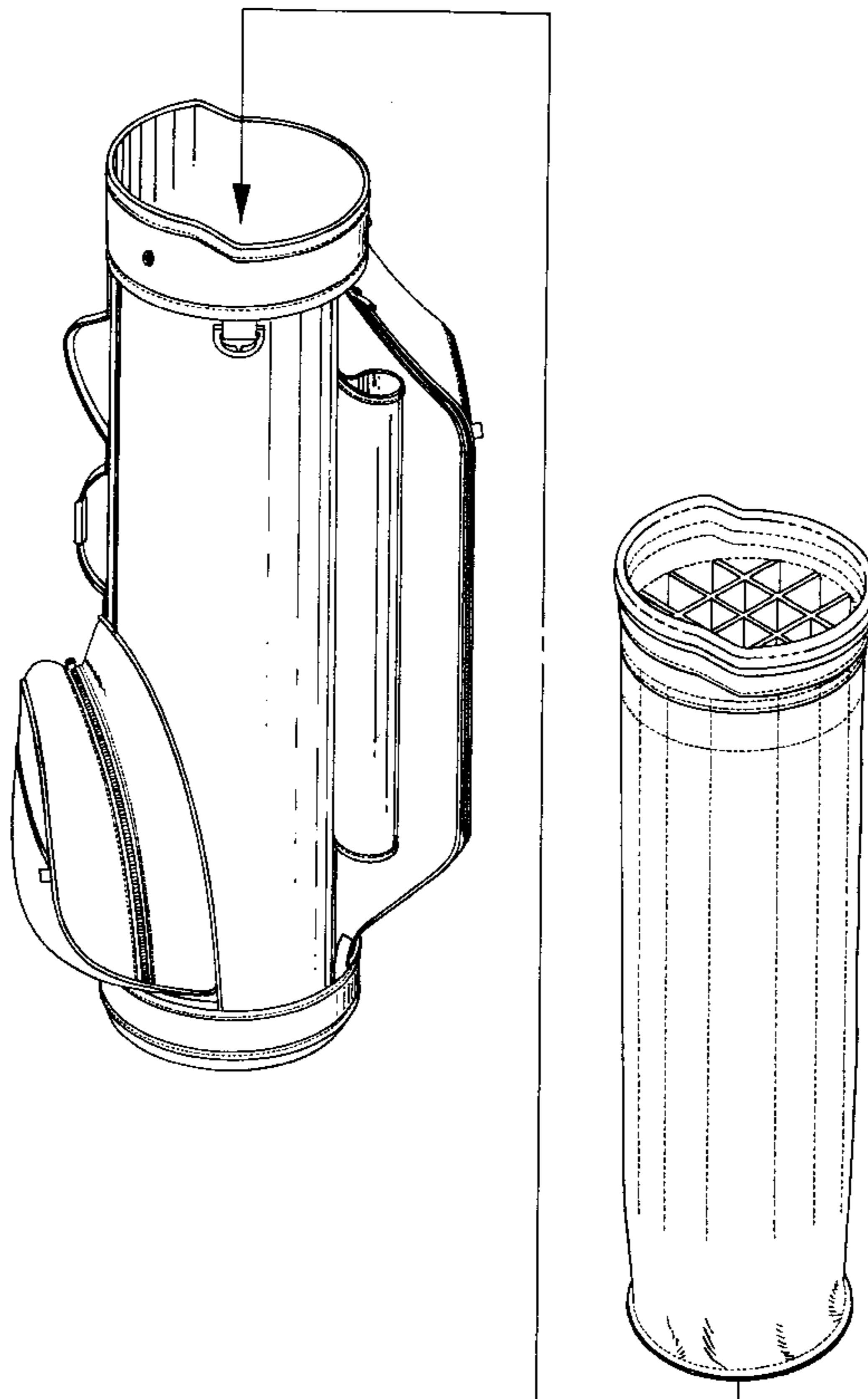

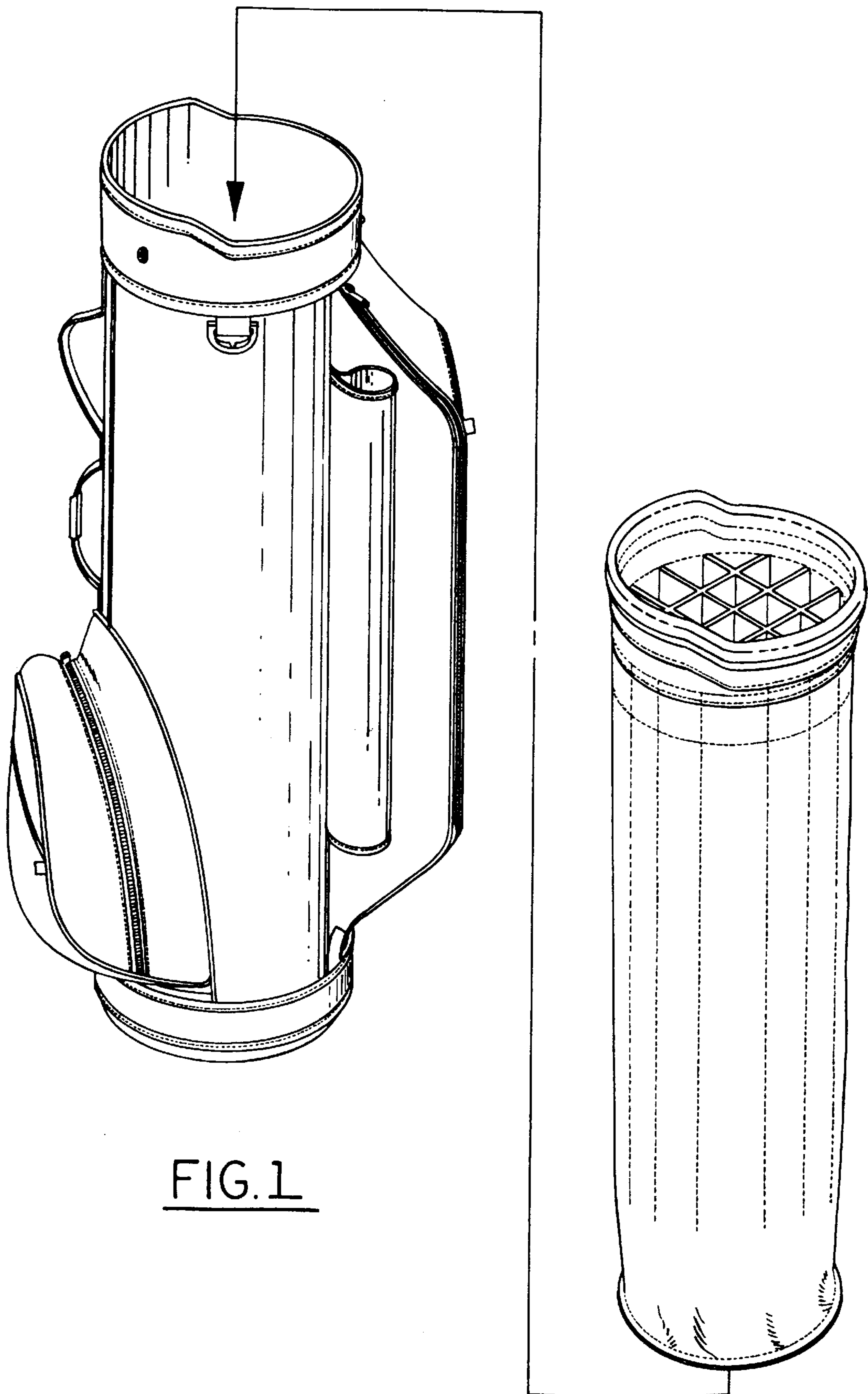

FIG. 1

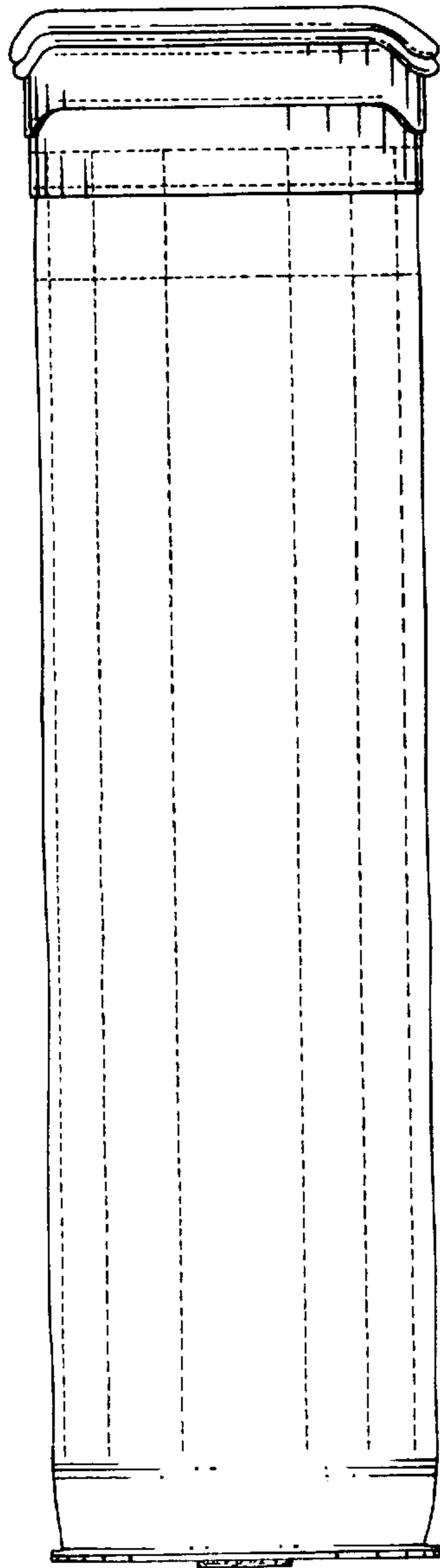

FIG. 2

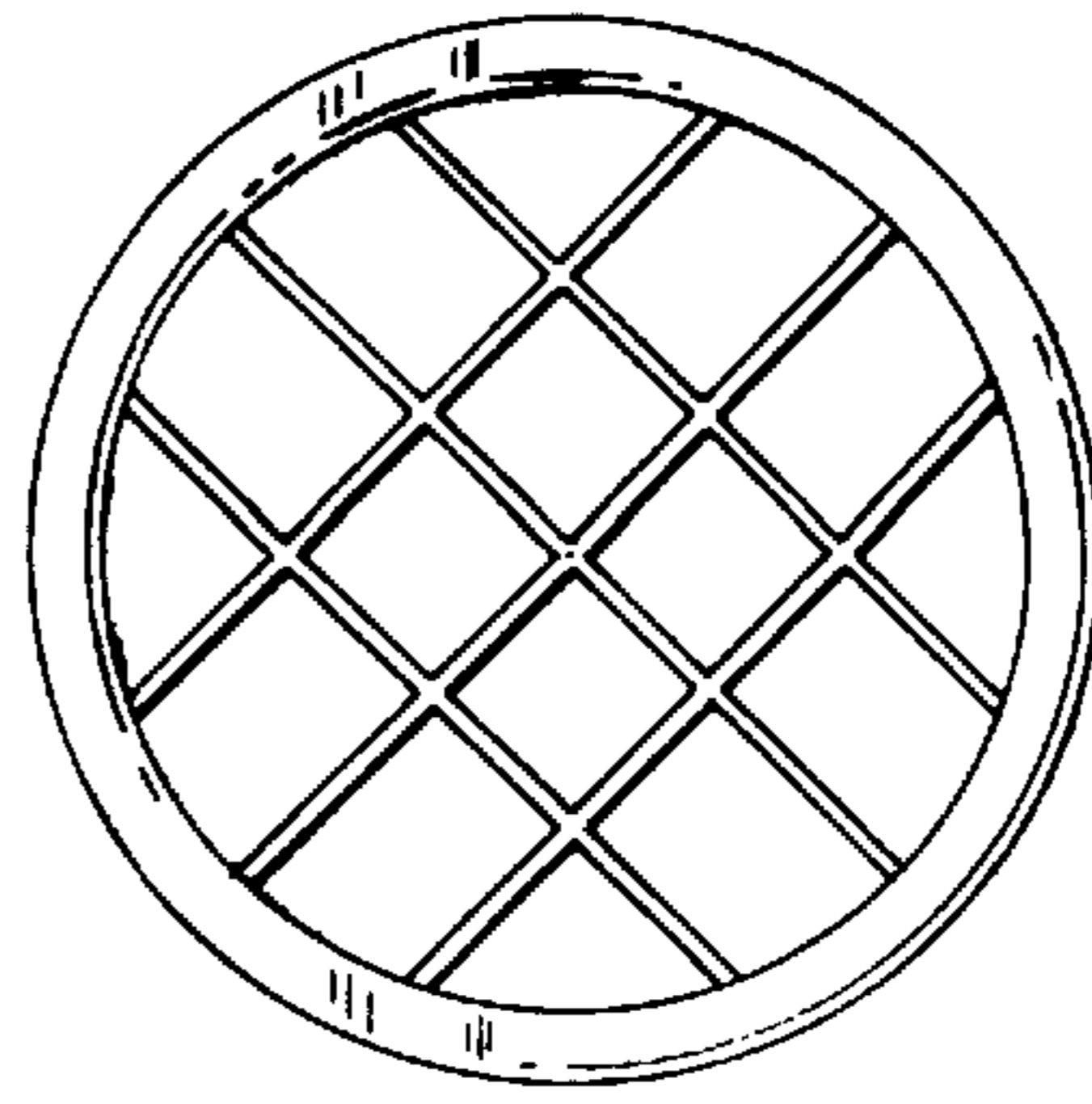

FIG. 3

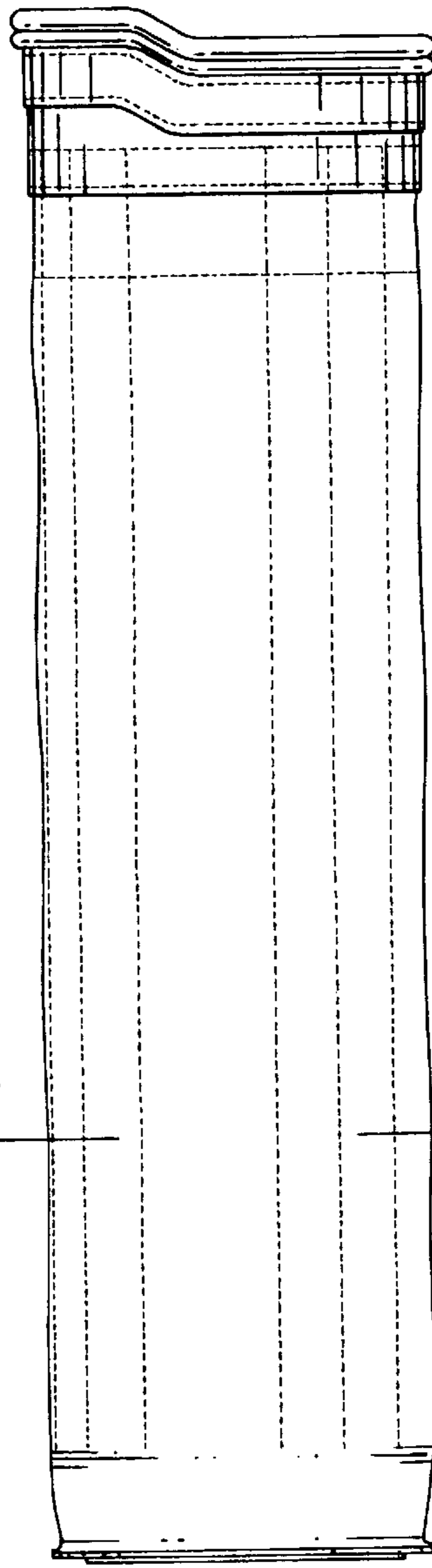

FIG. 4

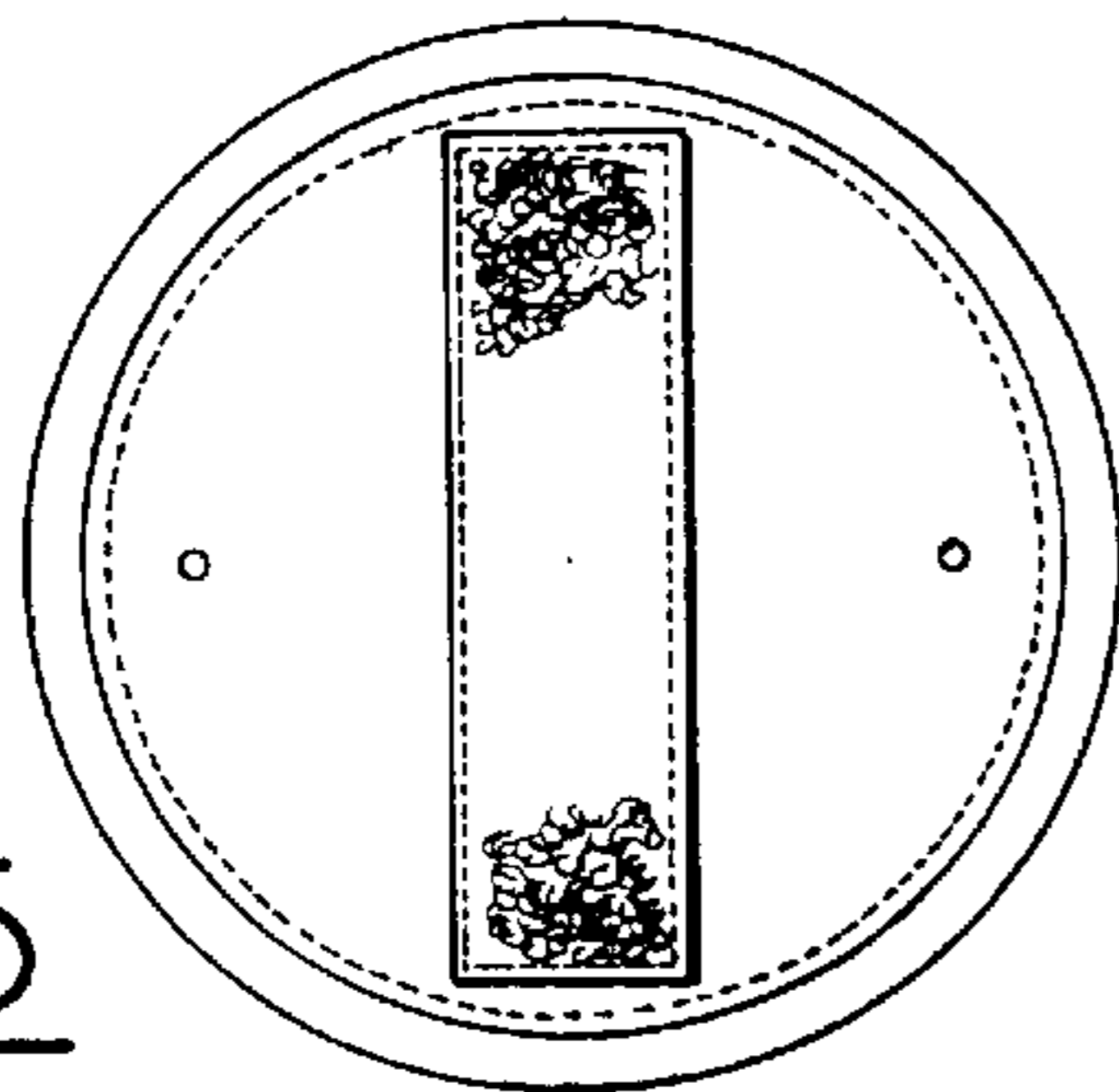

FIG. 5

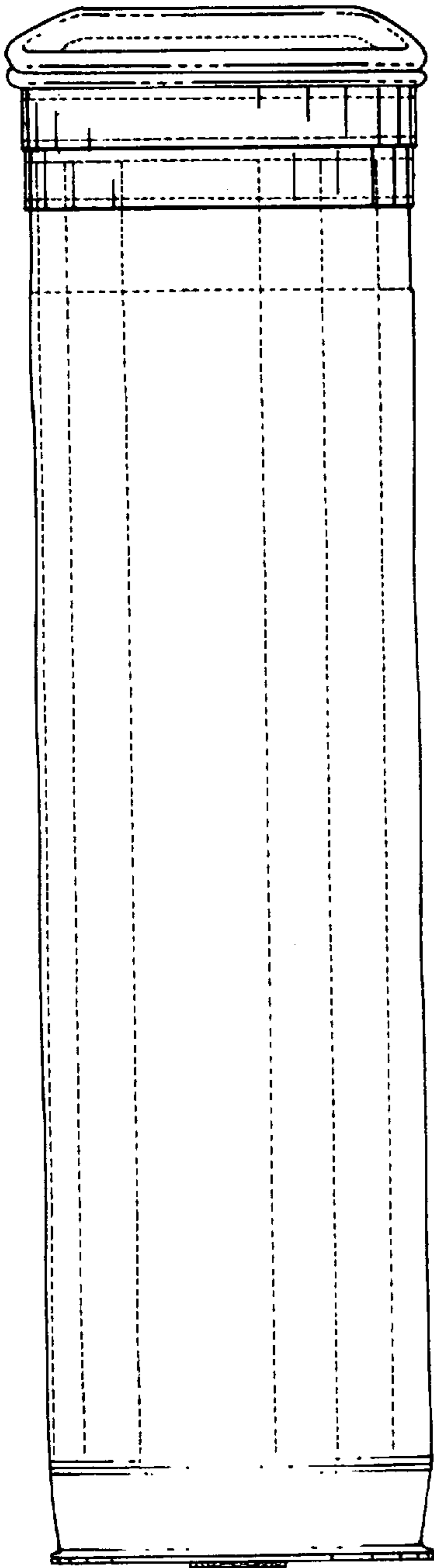

FIG. 6

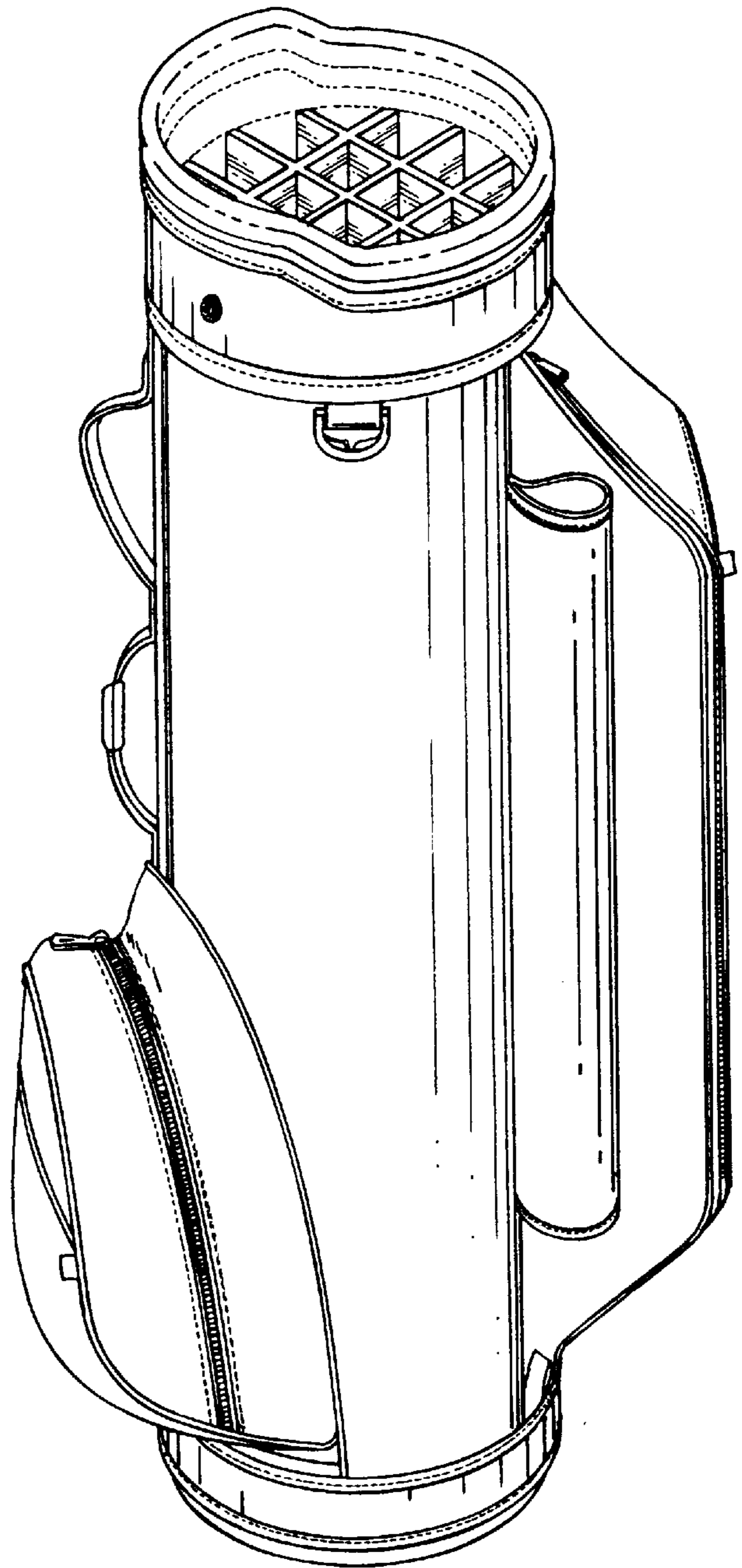

FIG. 7

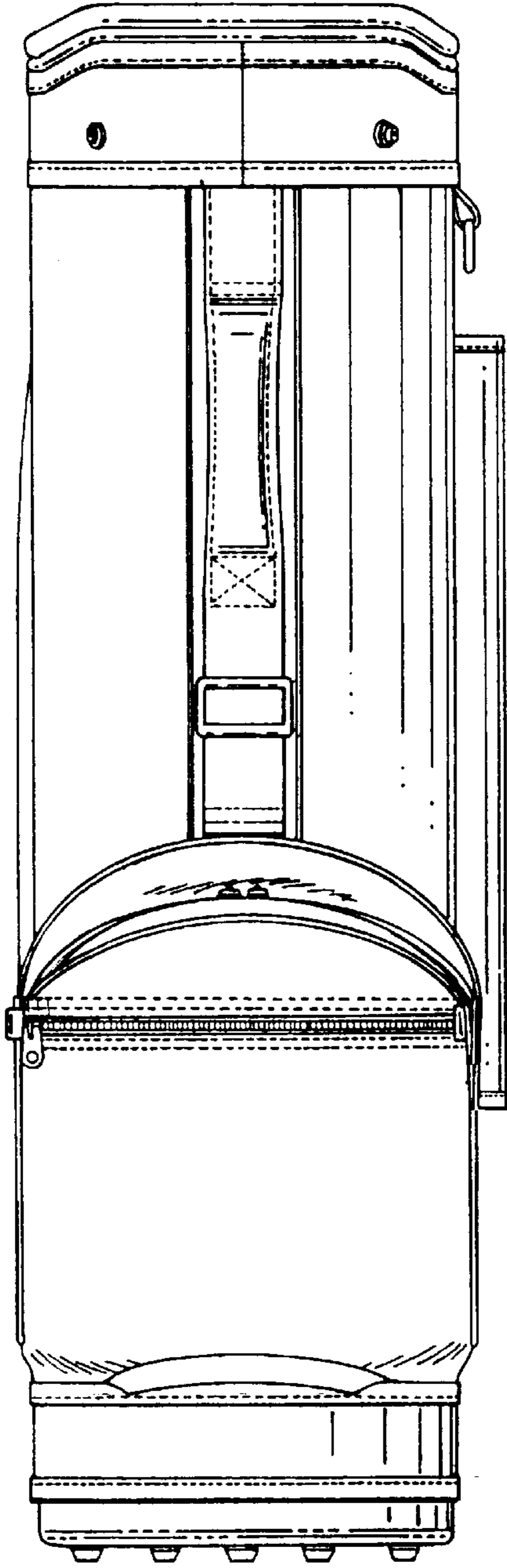

FIG. 8

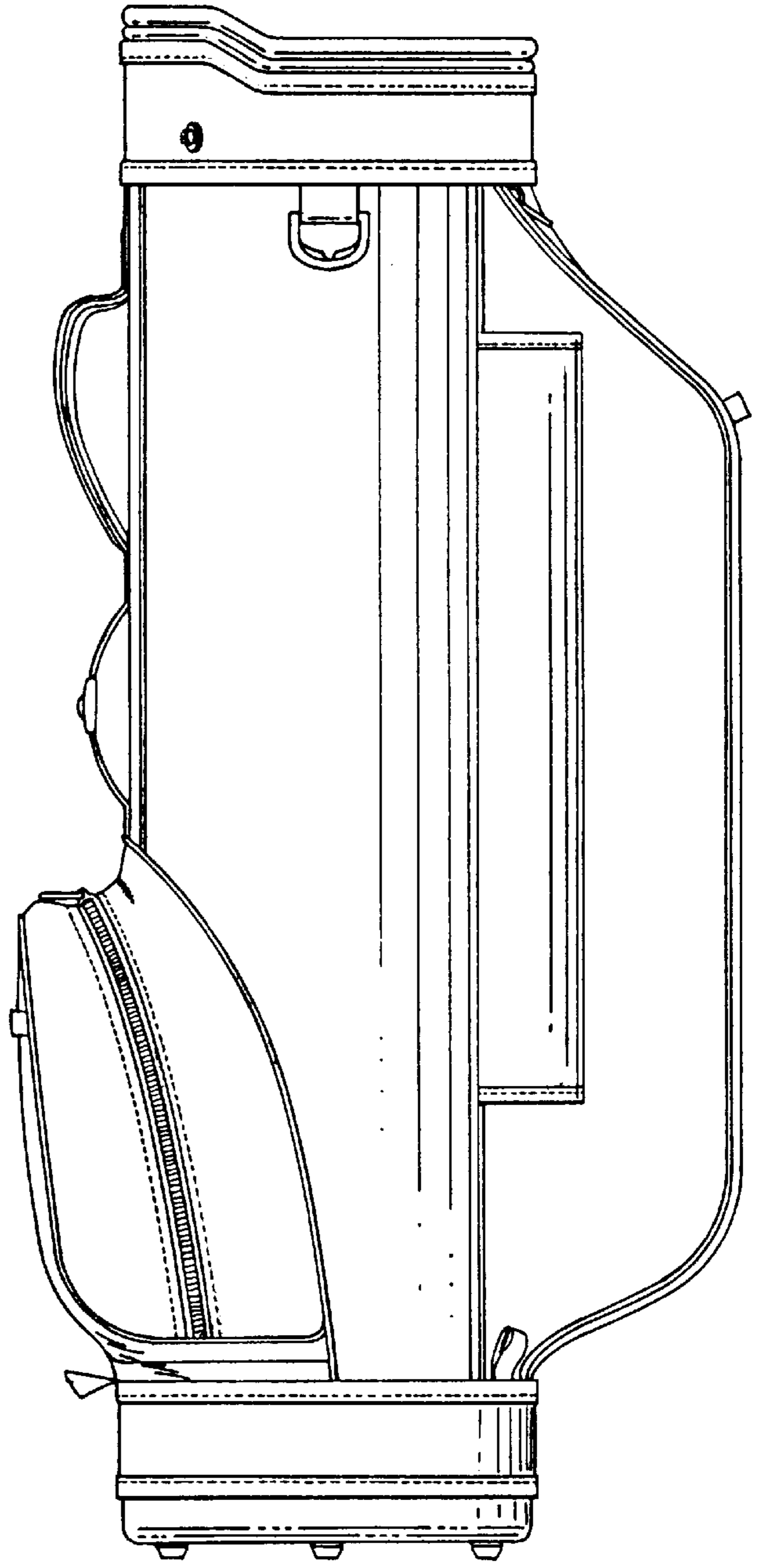

FIG. 9

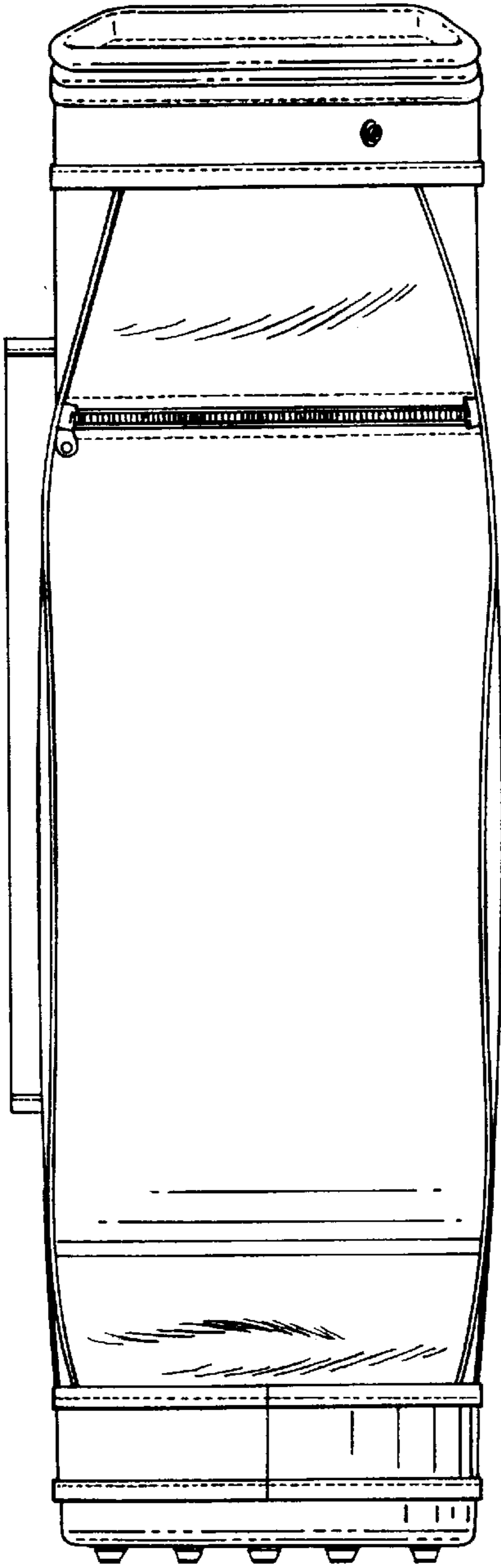

FIG.10

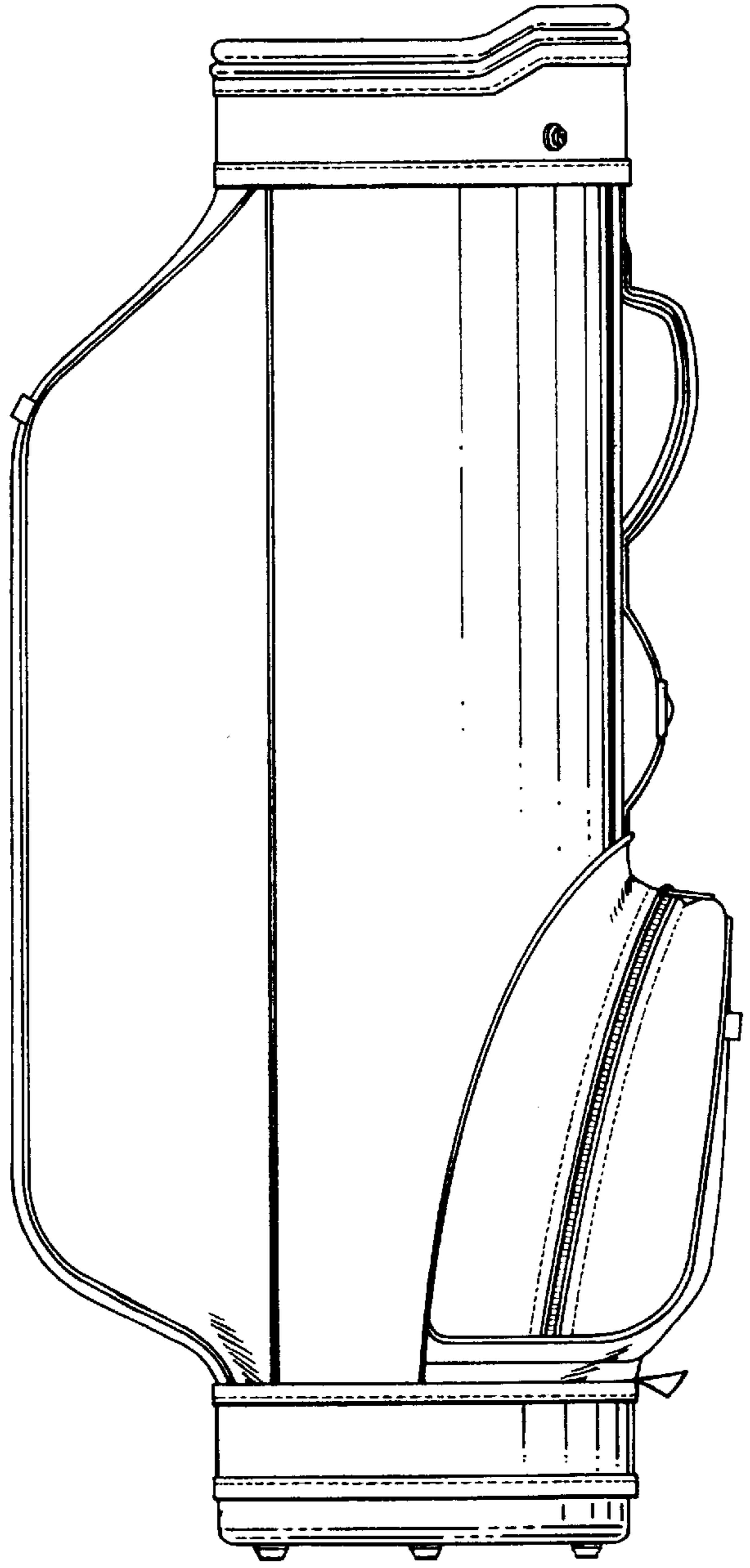

FIG.11

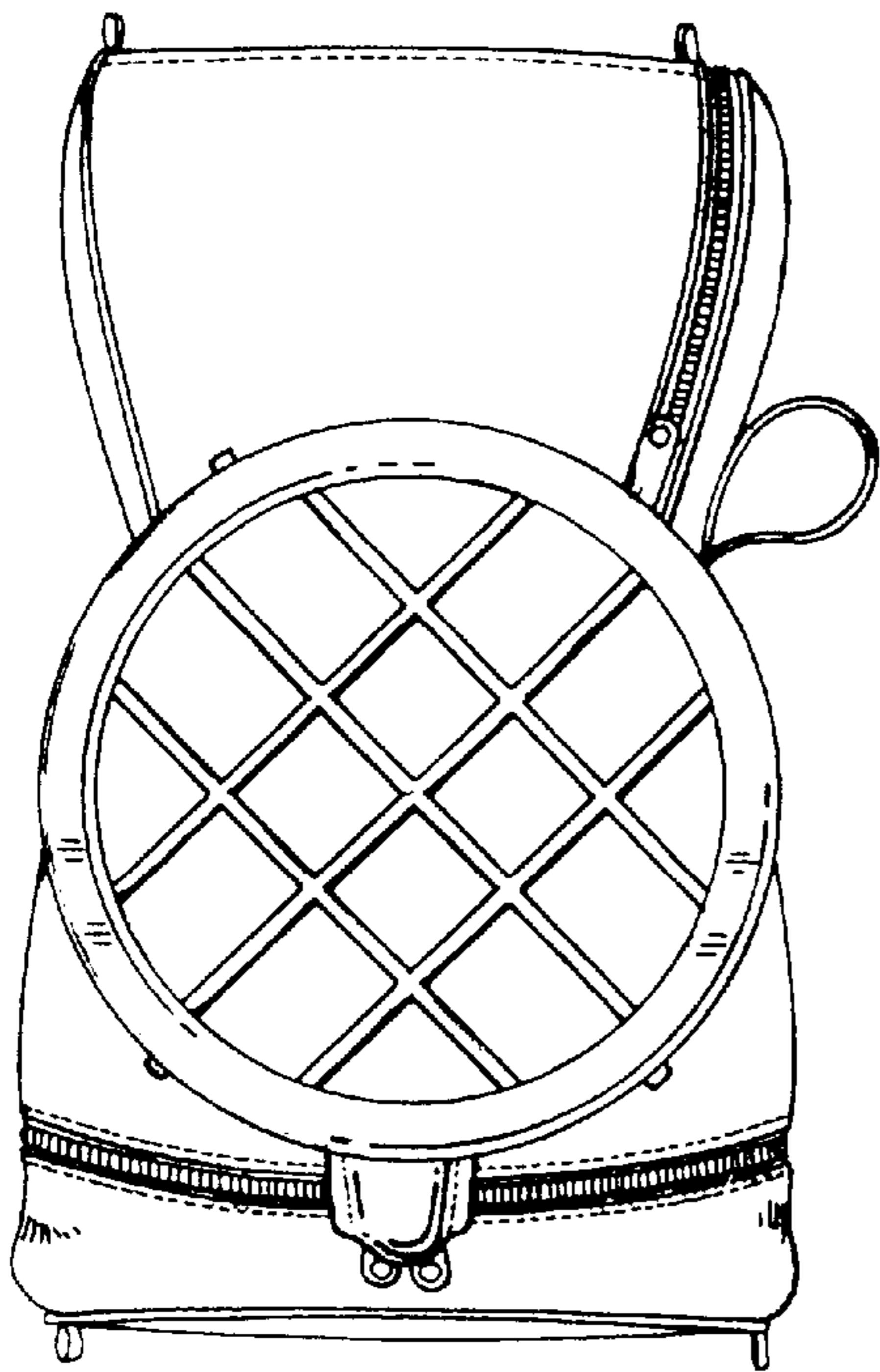

FIG. 12

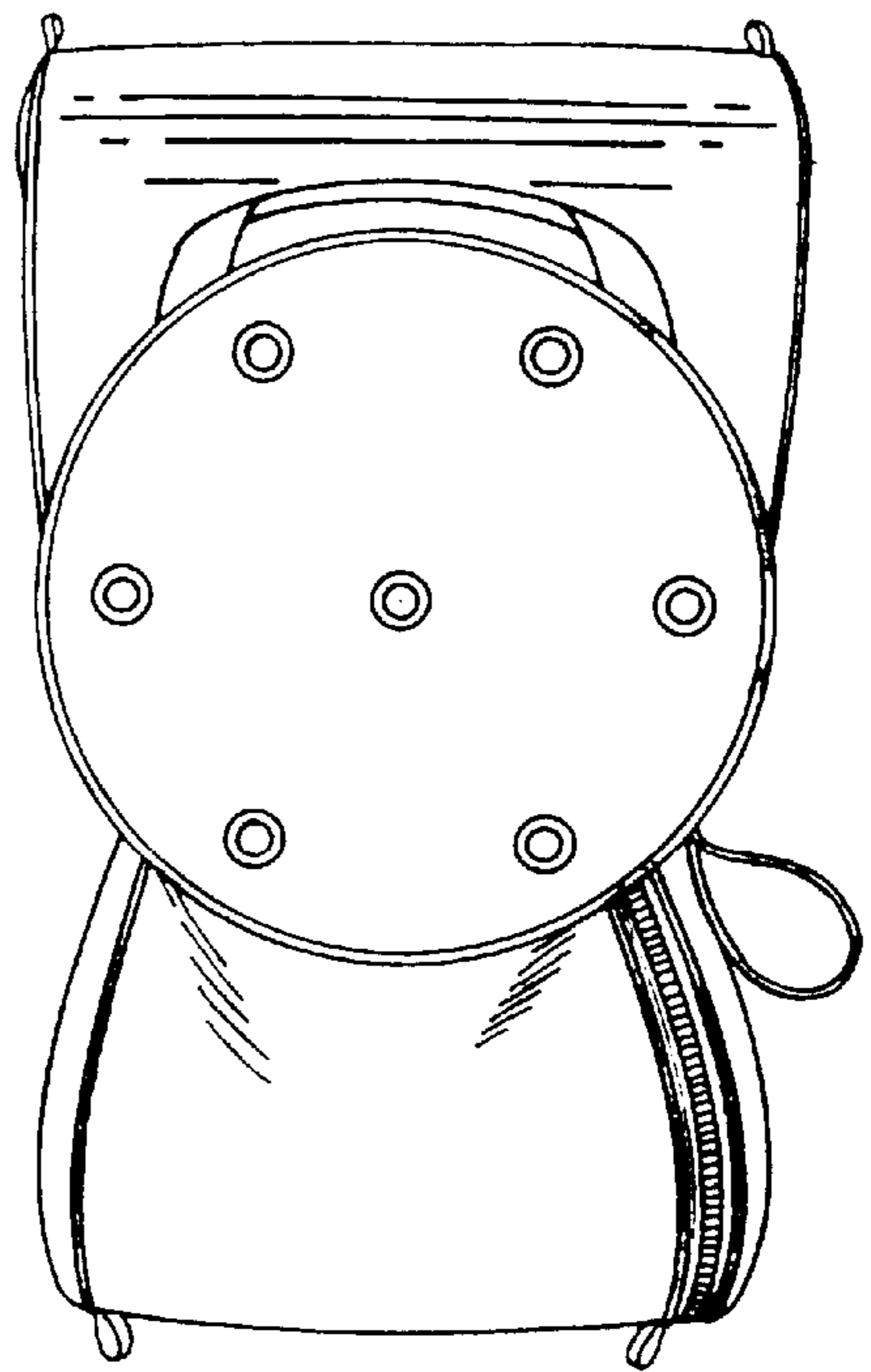

FIG. 13