



US00D412937S

# United States Patent [19] Franklin

[11] **Patent Number: Des. 412,937**

[45] **Date of Patent: \*\* Aug. 17, 1999**

[54] **REUSABLE LOGO TAG**

[76] Inventor: **Oscar L. Franklin**, 2835 Clayton St.,  
Denver, Colo. 80205

[\*\*] Term: **14 Years**

[21] Appl. No.: **29/080,757**

[22] Filed: **Dec. 15, 1997**

[51] **LOC (6) Cl. .... 19-08**

[52] **U.S. Cl. .... D20/27; D2/891**

[58] **Field of Search .... D20/10, 40, 22,  
D20/27, 19; 40/299, 642.02, 329, 640;  
2/209.13, 181, 181.4; D2/895, 891**

[56] **References Cited**

**U.S. PATENT DOCUMENTS**

3,808,718	5/1974	Christiansen .....	40/2 R
4,154,011	5/1979	Rakestraw et al. ....	40/21 C
4,829,604	5/1989	Allen et al. ....	2/170
4,832,010	5/1989	Lerman .....	128/165
4,843,651	7/1989	Gramza et al. ....	2/161 A
4,991,234	2/1991	Greenberg .....	2/170
5,002,212	3/1991	Charleton .....	224/221
5,428,844	7/1995	Dougherty .....	2/209.13
5,466,215	11/1995	Lair et al. ....	602/21
5,493,733	2/1996	Pospisil .....	2/209.13
5,519,892	5/1996	Pizzacar .....	2/181
5,538,289	7/1996	Cassis .....	283/74
5,600,855	2/1997	Ramirez .....	2/209.13
5,687,425	11/1997	Blosser .....	2/209.13

*Primary Examiner*—Susan J. Lucas  
*Assistant Examiner*—Jennifer Rivard  
*Attorney, Agent, or Firm*—Stuart T. Langley; Holland & Hart LLP

[57] **CLAIM**

The ornamental design for reusable logo tag, as shown and described.

**DESCRIPTION**

FIG. 1 is a front perspective view of a reusable logo tag showing our new design in full lines with the broken lines showing environmental association with an adjustable cap and with a printed logo, the cap and logo being for illustrative purposes only and forming no part of the claimed design;

FIG. 2 is a rear perspective view;

FIG. 3 is a front elevation view thereof;

FIG. 4 is a top plan view thereof;

FIG. 5 is a side elevation view thereof;

FIG. 6 is a back elevation view thereof;

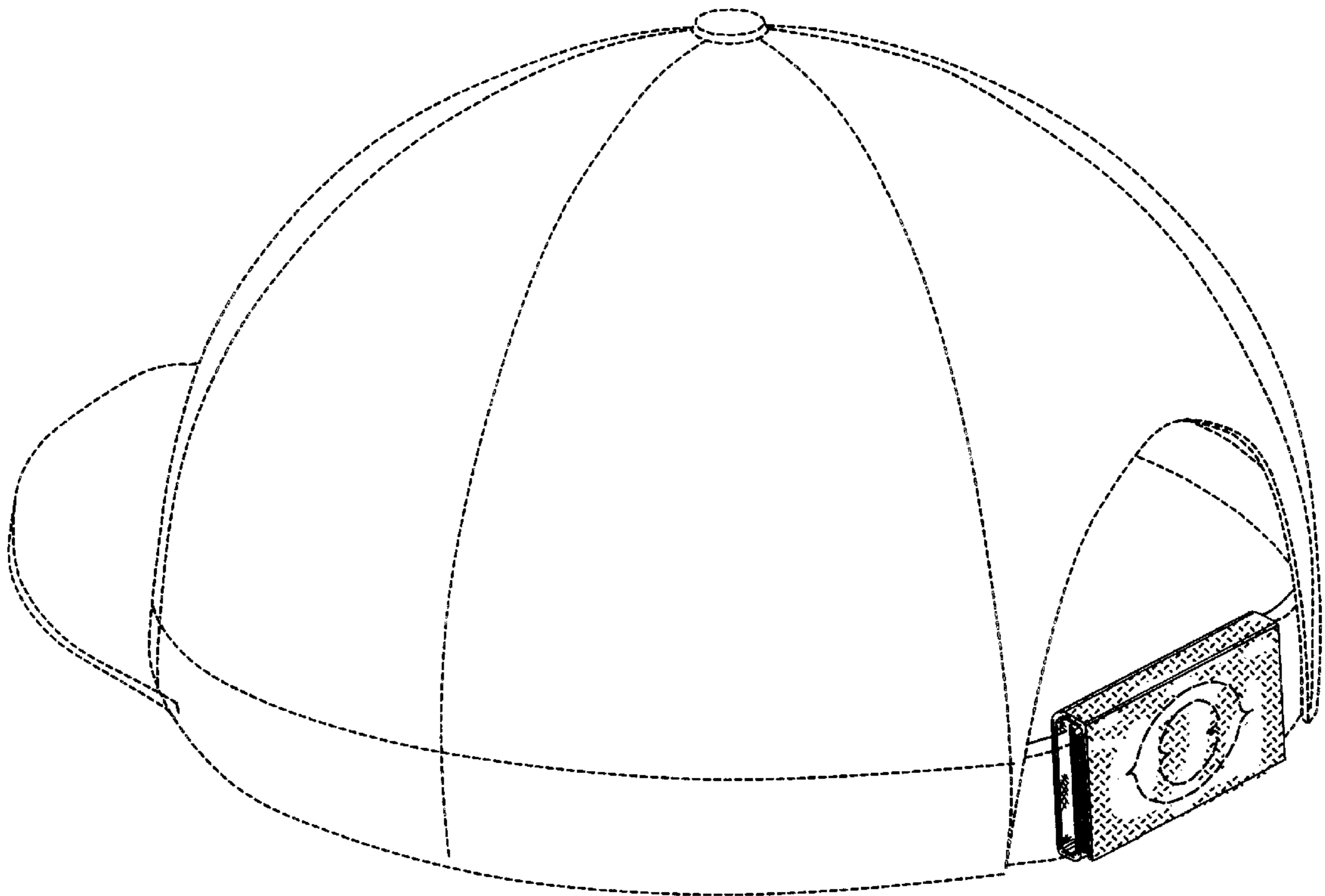
FIG. 7 is a bottom plan view thereof;

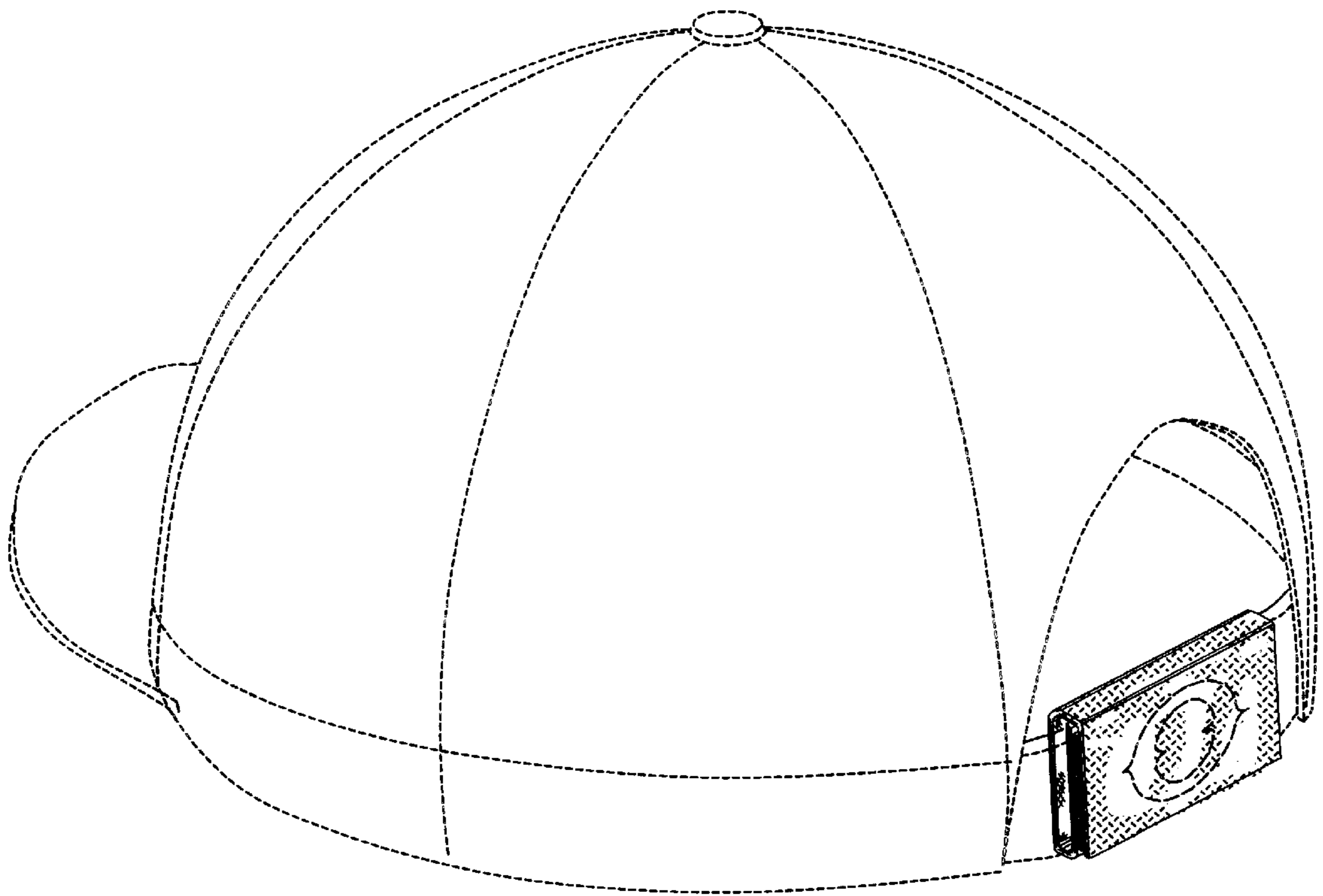
FIG. 8 is an unfolded plan view thereof with a printed logo illustrated in broken lines for illustrative purposes only and forming no part of the claimed invention; and,

FIG. 9 is a side elevation view of an unfolded reusable logo tag in accordance with the present invention.

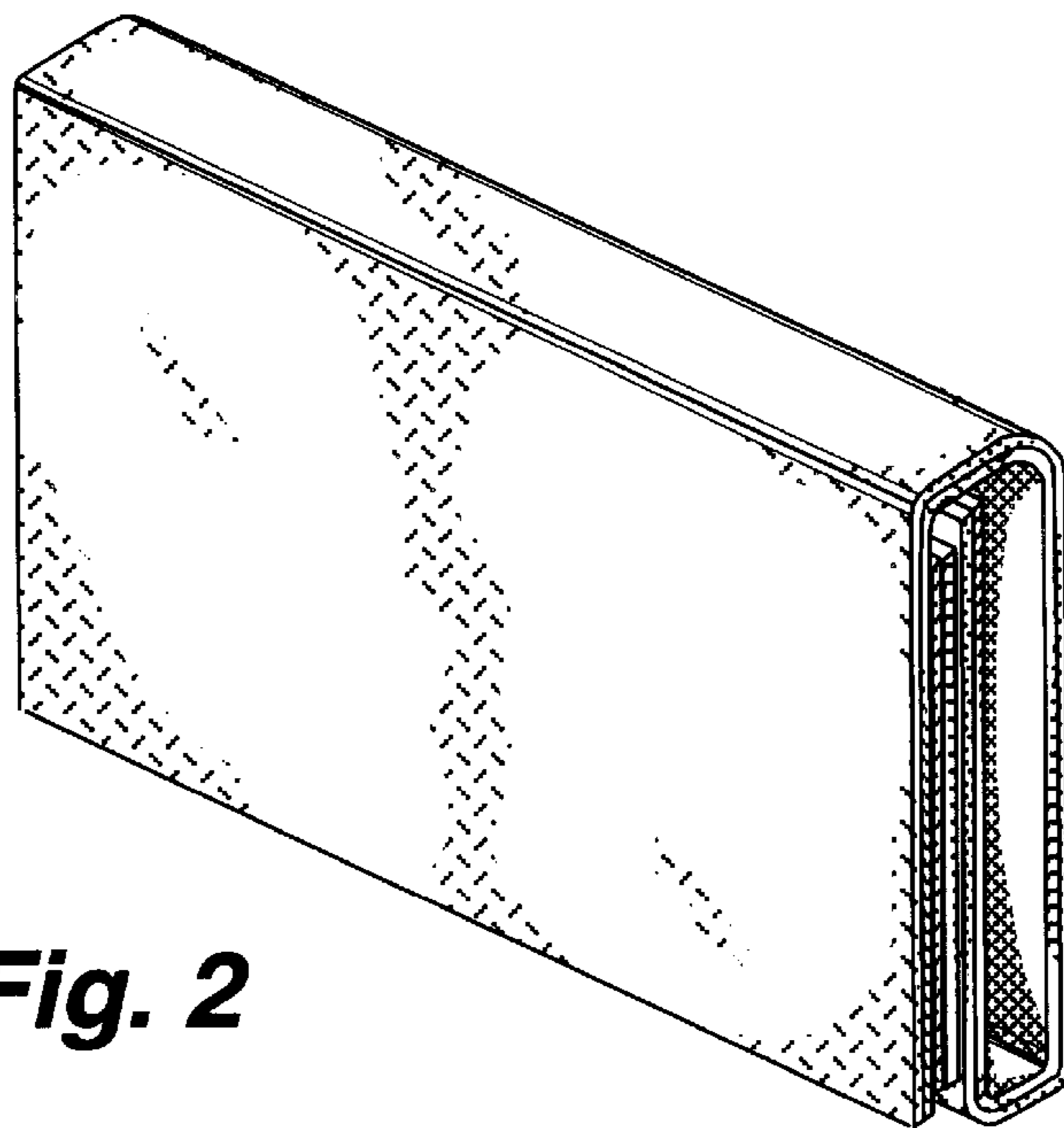
The pattern is partially shown for convenience of illustration, it being understood that the pattern is uniformly continuous over the surface of the reusable logo tag.

**1 Claim, 3 Drawing Sheets**

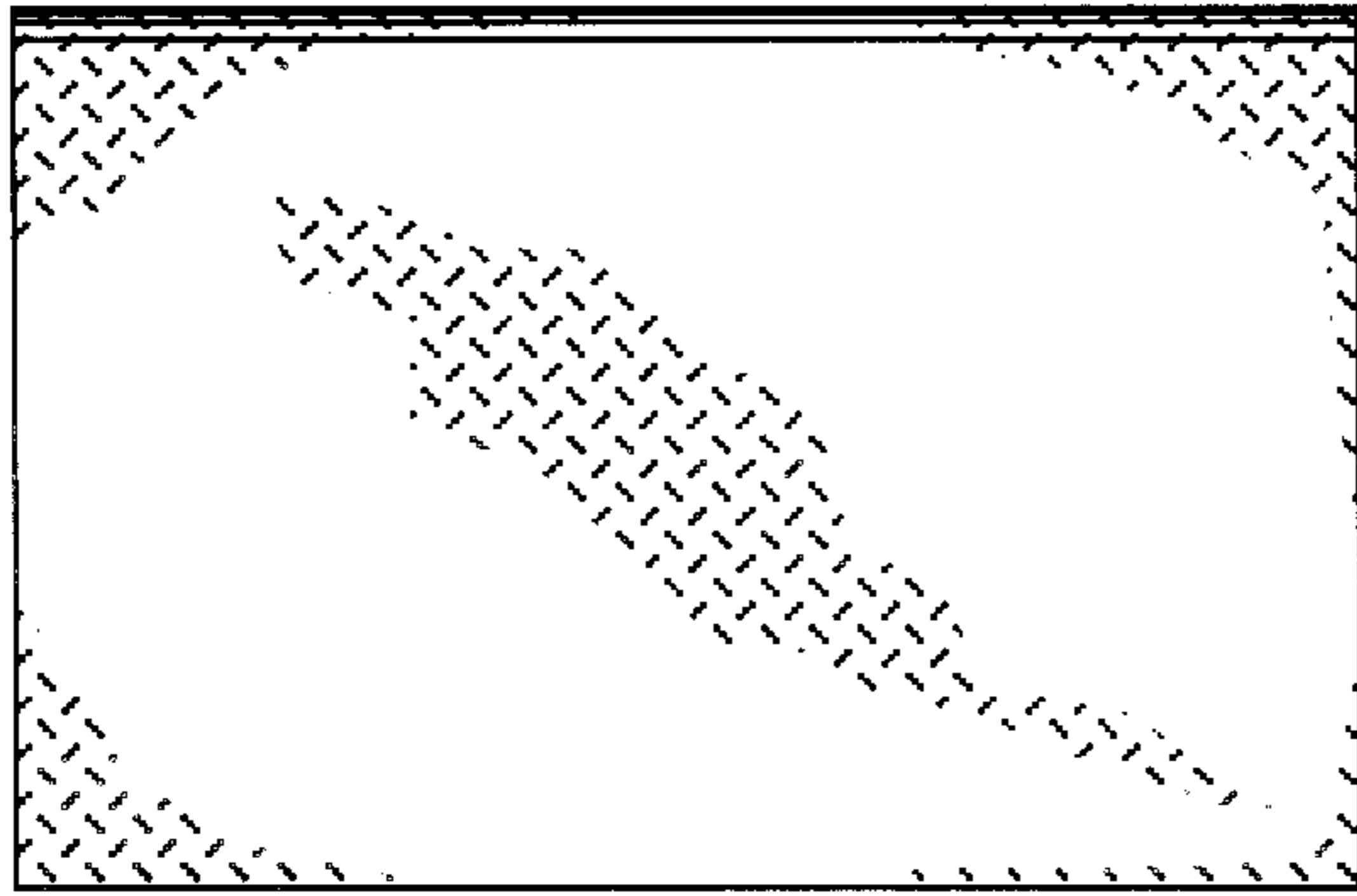




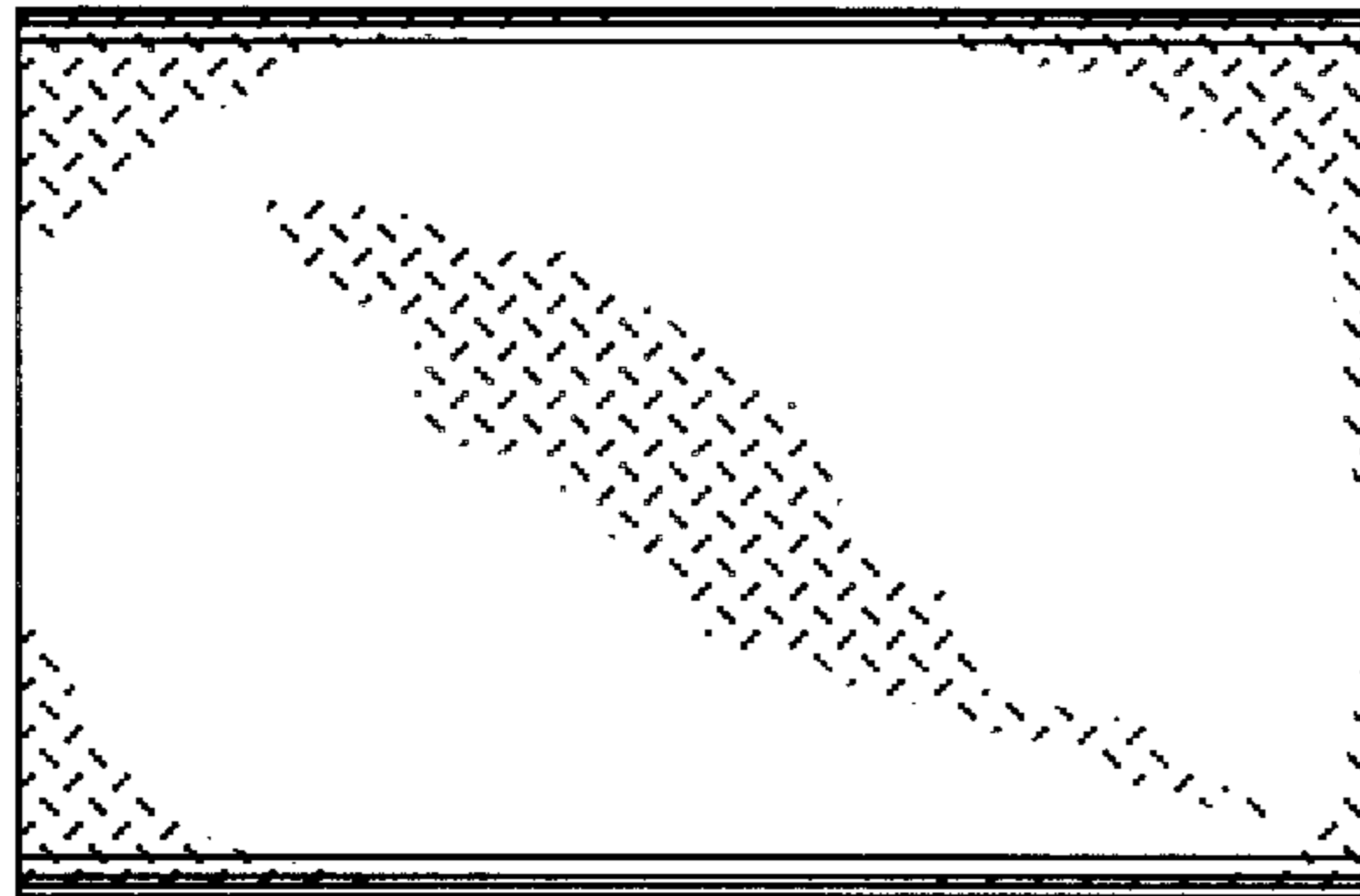
**Fig. 1**



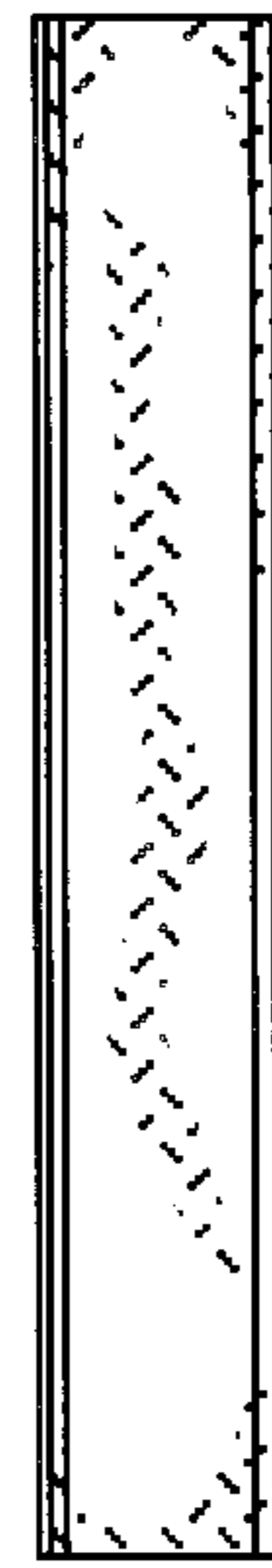
**Fig. 2**



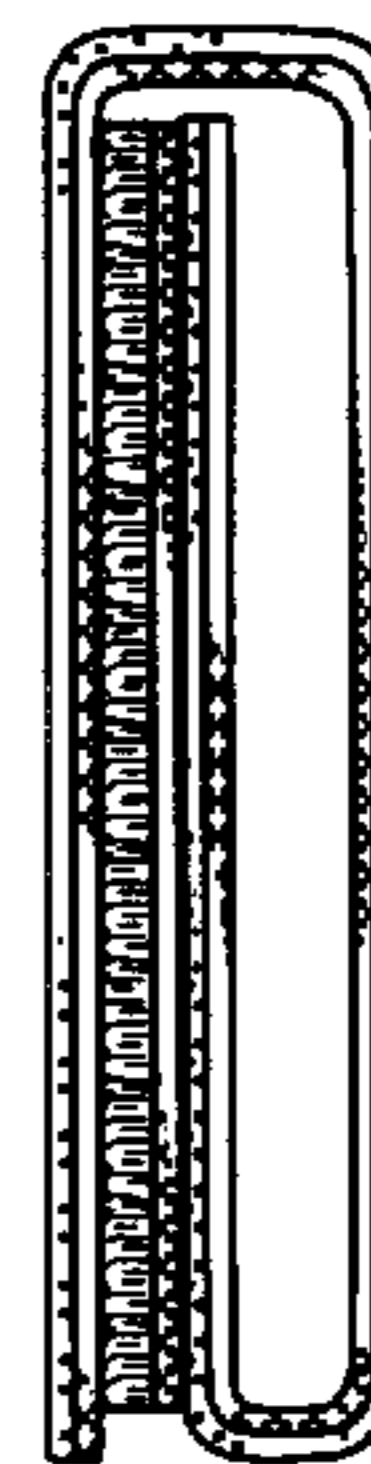
**Fig. 3**



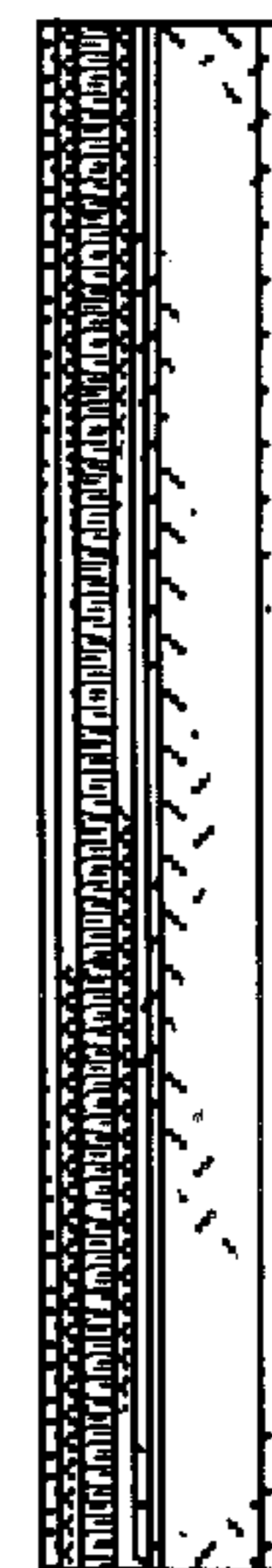
**Fig. 6**



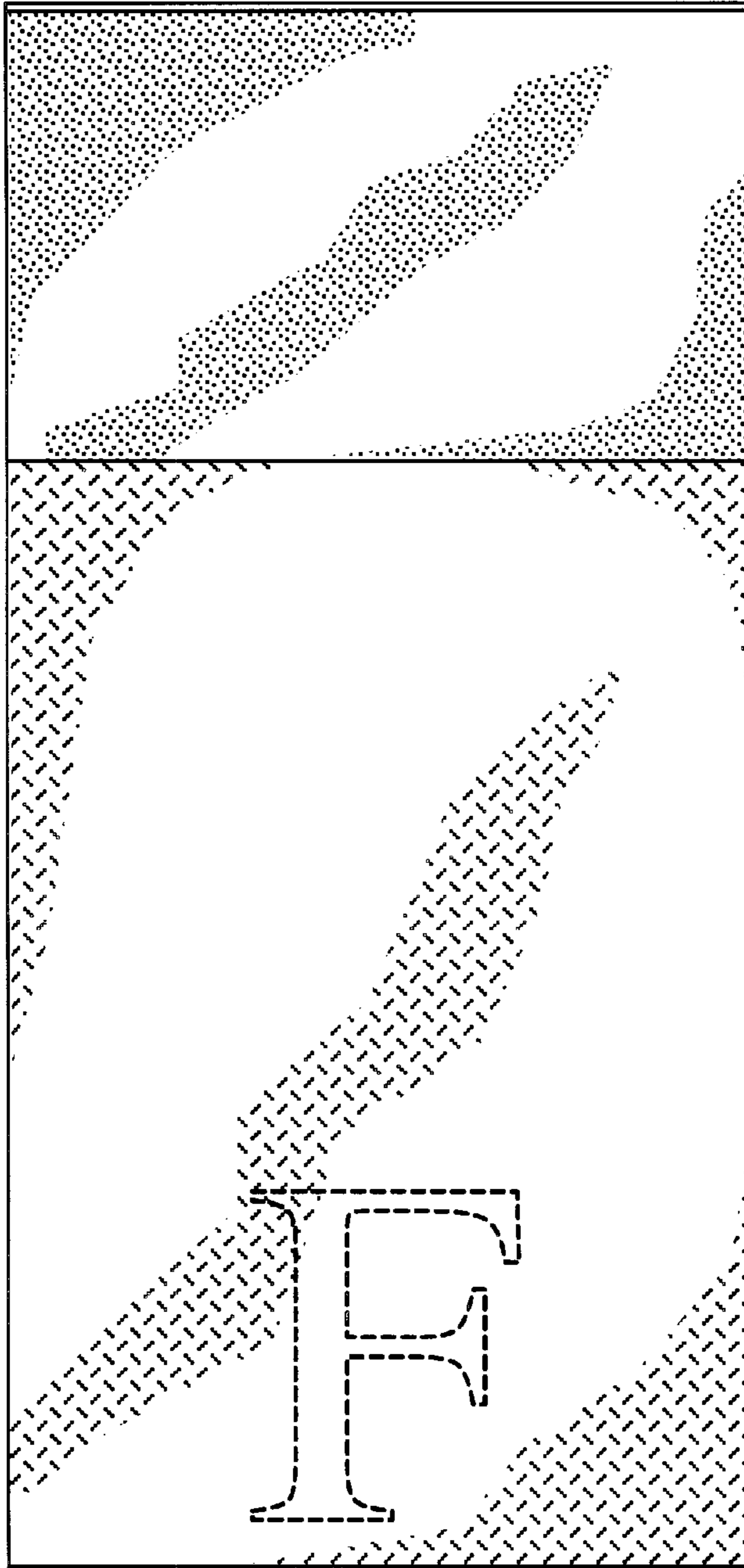
**Fig. 4**



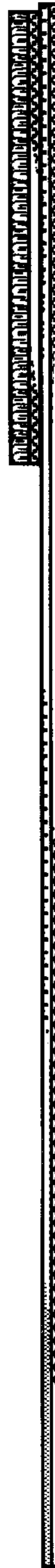
**Fig. 5**



**Fig. 7**



**Fig. 8**



**Fig. 9**