



US00D412765S

# United States Patent [19] Eckstrand

[11] Patent Number: Des. 412,765

[45] Date of Patent: \*\* Aug. 10, 1999

[54] CHEST GUARD

[76] Inventor: **Becky A. Eckstrand**, 28 Pleasantview, Oswego, Ill. 60543

[\*\*] Term: **14 Years**

[21] Appl. No.: **29/081,974**

[22] Filed: **Jan. 12, 1998**

4,308,629	1/1982	Freemon .....	D29/100
4,799,675	1/1989	Helmer .....	128/870
4,981,307	1/1991	Walsh .....	D29/100
5,844,246	12/1998	Marchione .....	2/455
5,891,070	4/1999	Shirouzu et al. ....	602/19

*Primary Examiner*—Louis S. Zarfes  
*Assistant Examiner*—Robert A. Delehanty  
*Attorney, Agent, or Firm*—Welsh & Katz, Ltd.

### Related U.S. Application Data

[63] Continuation-in-part of application No. 29/060,105, Sep. 12, 1996.

[51] LOC (6) Cl. .... **30-04**

[52] U.S. Cl. .... **D29/101**

[58] Field of Search ..... D29/100, 101, D29/122; 2/120, 92, 456, 462, 913, 908, 44, 45, 46, 455, 489, 463, 464, 465, 467; 250/515.1, 516.1, 519.1; 602/19; 128/869, 870, 874, 875; D24/190; D2/860, 861, 862

### [56] References Cited

#### U.S. PATENT DOCUMENTS

D. 254,813	4/1980	Pujals, Jr. ....	D24/190
D. 351,051	10/1994	Pearson et al. ....	D29/101
D. 361,654	8/1995	Petracco .....	D29/101
D. 374,313	10/1996	Munoz .....	D24/190
1,561,399	11/1925	Begg .....	D29/100
1,983,636	12/1934	Palkens .....	D29/101
2,102,281	12/1937	Pringle .....	D29/101
3,554,190	1/1971	Kaplan .....	D29/100

### [57] CLAIM

The ornamental design for a chest guard, as shown and described.

### DESCRIPTION

FIG. 1 is a perspective view of a chest guard of the claimed design;  
FIG. 2 is a front elevational view of the chest guard of FIG. 1 of the claimed design;  
FIG. 3 is a rear elevational view of the chest guard of FIG. 1 of the claimed design;  
FIG. 4 is a left end elevational view of the chest guard of FIG. 1 of the claimed design;  
FIG. 5 is a right end elevational view of the chest guard of FIG. 1, shown from the opposite side as shown in FIG. 4;  
FIG. 6 is an elevational inside view of the chest guard of FIG. 1, shown unfastened and expanded;  
FIG. 7 is an elevational outside view of the chest guard of FIG. 1, shown unfastened and expanded; and,  
FIG. 8 is a bottom view of the chest guard of FIG. 1 of the claimed design.

The broken lines in the drawing represent stitching.

**1 Claim, 5 Drawing Sheets**

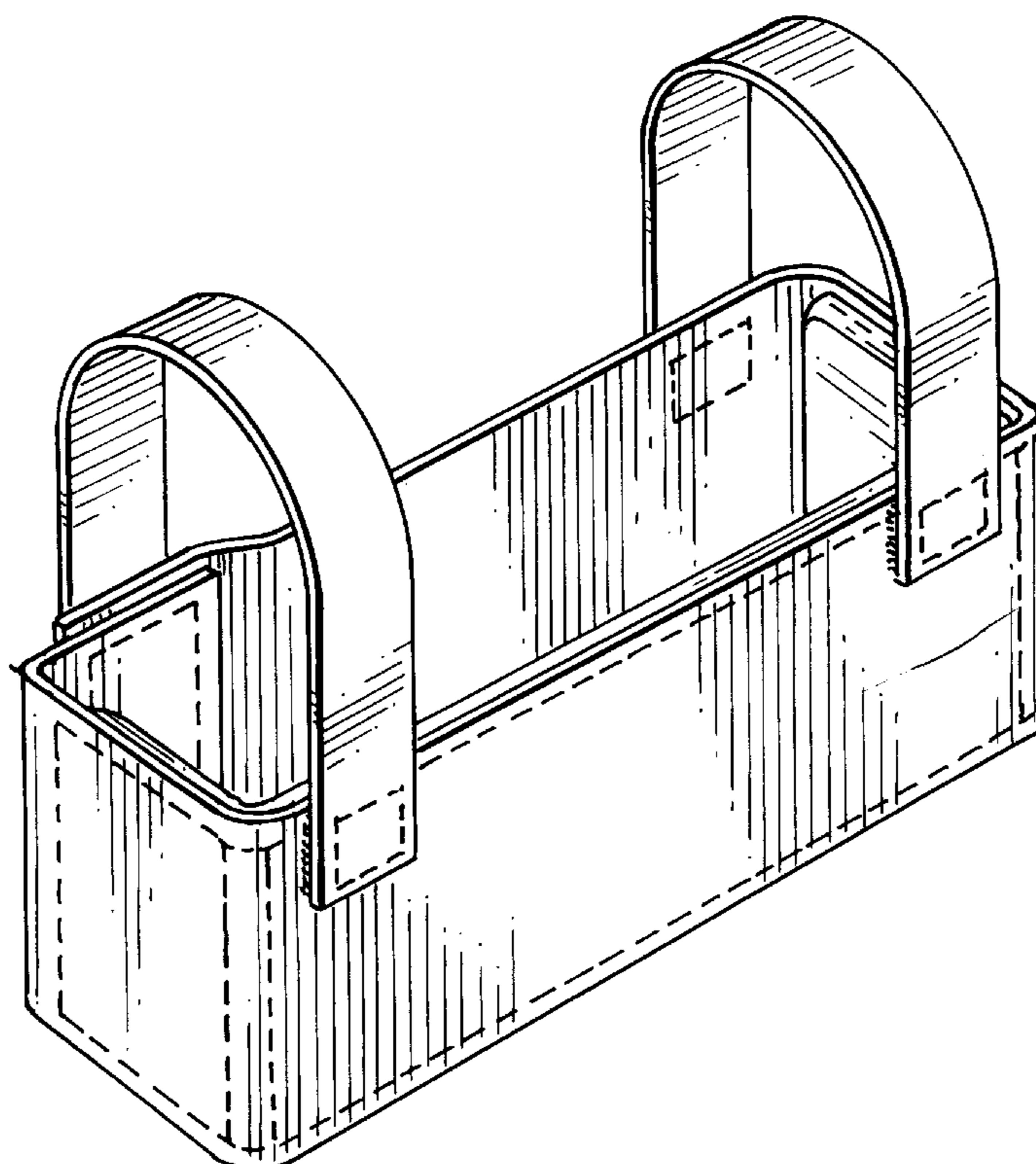

FIG. 1

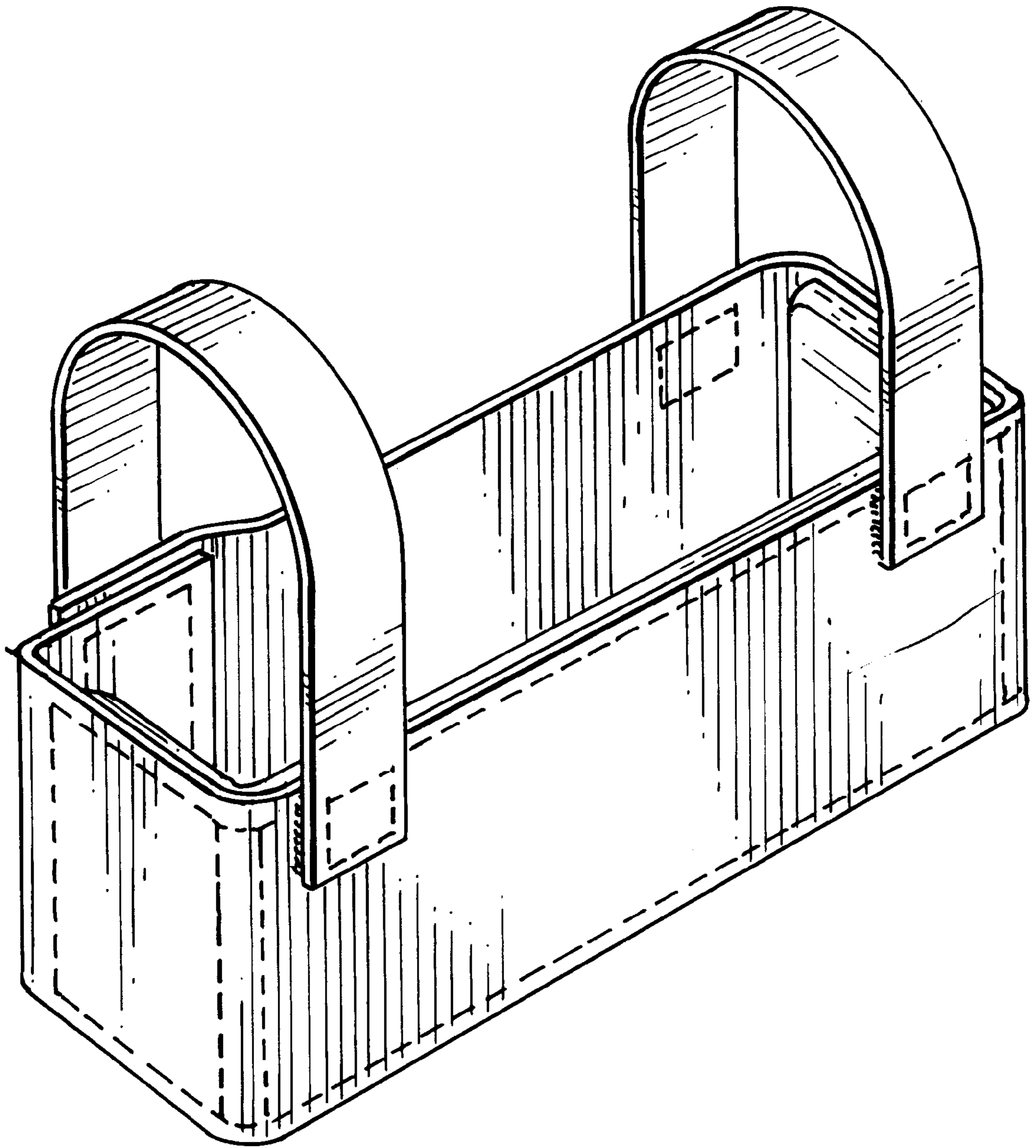

FIG. 2

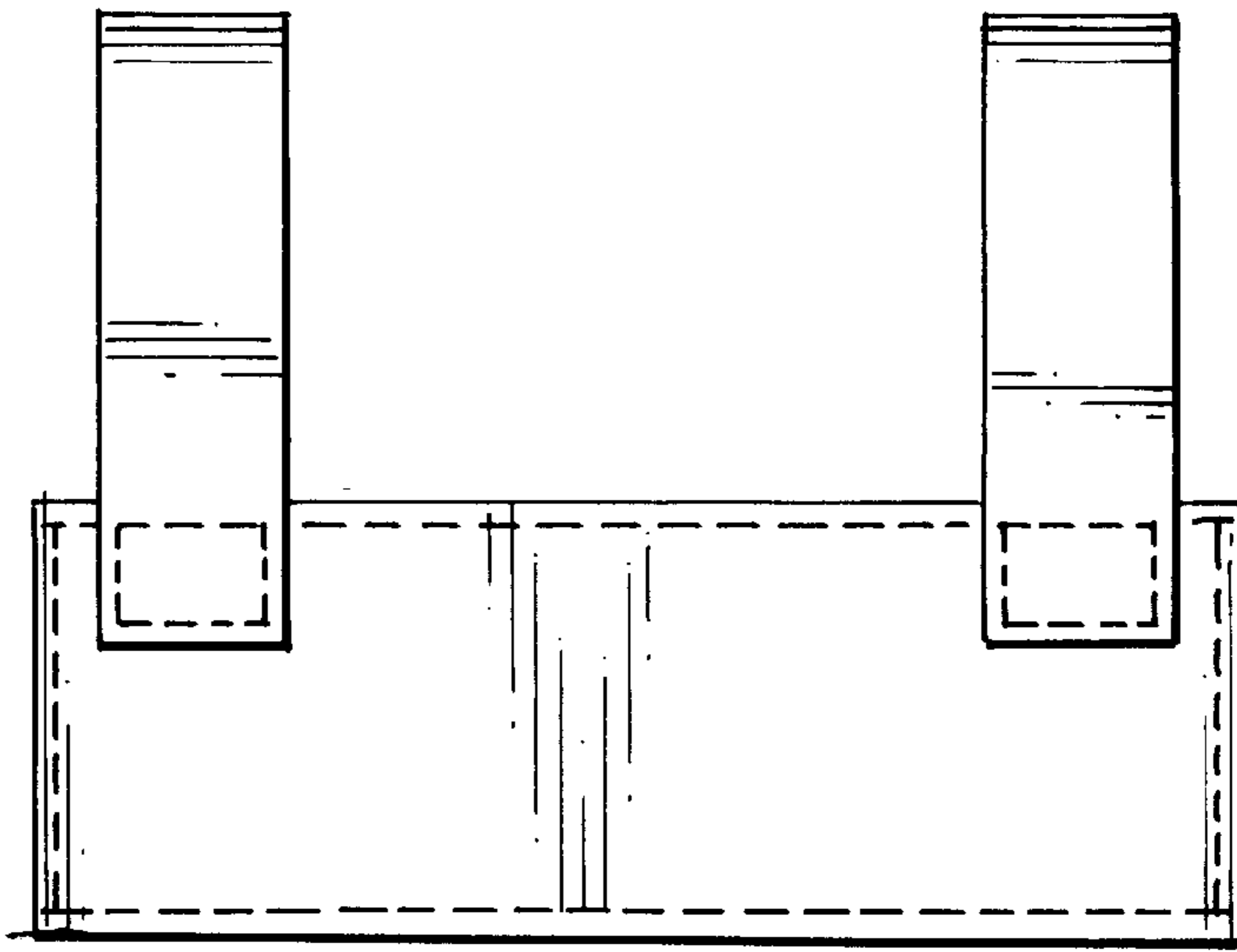

FIG. 3

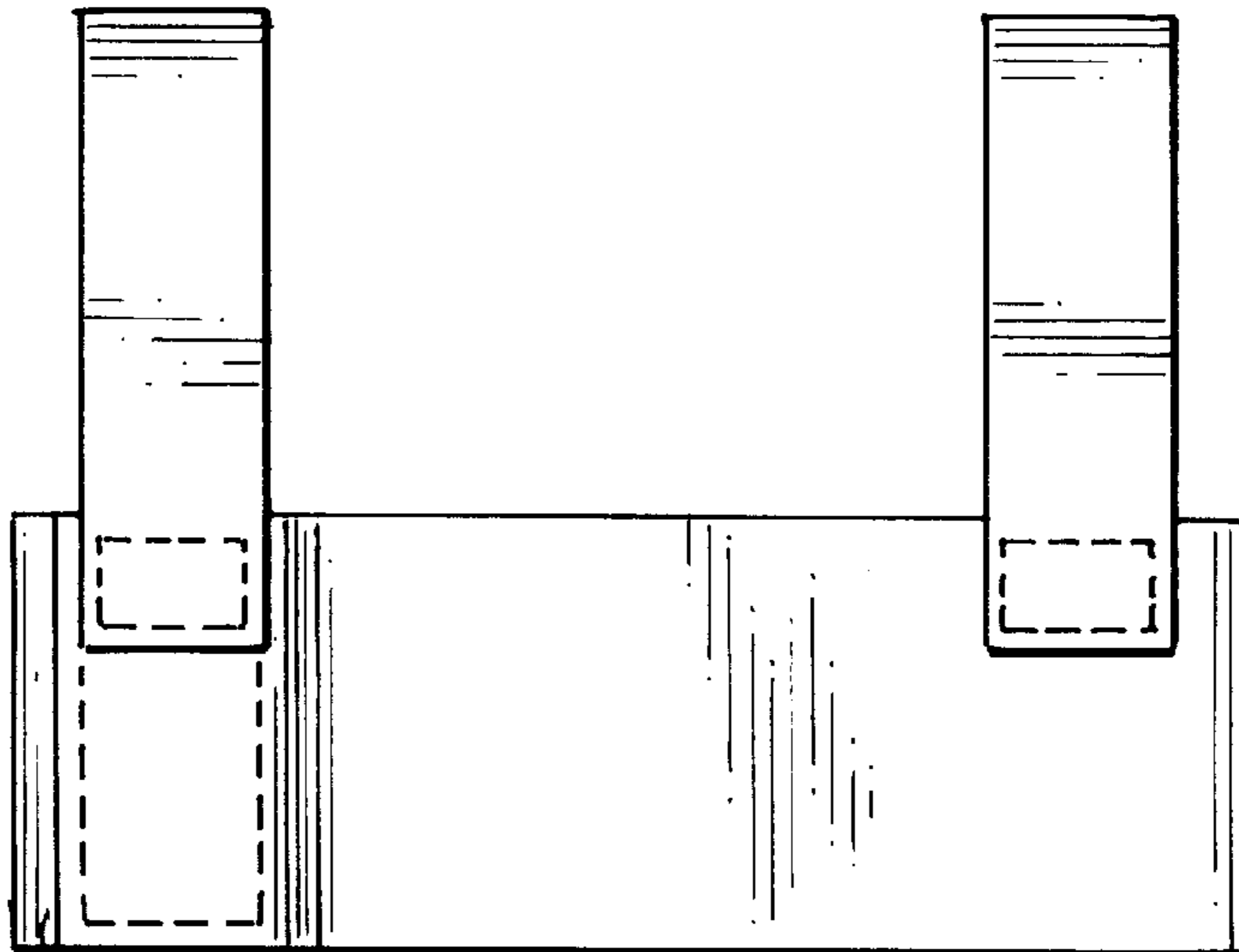

FIG. 4

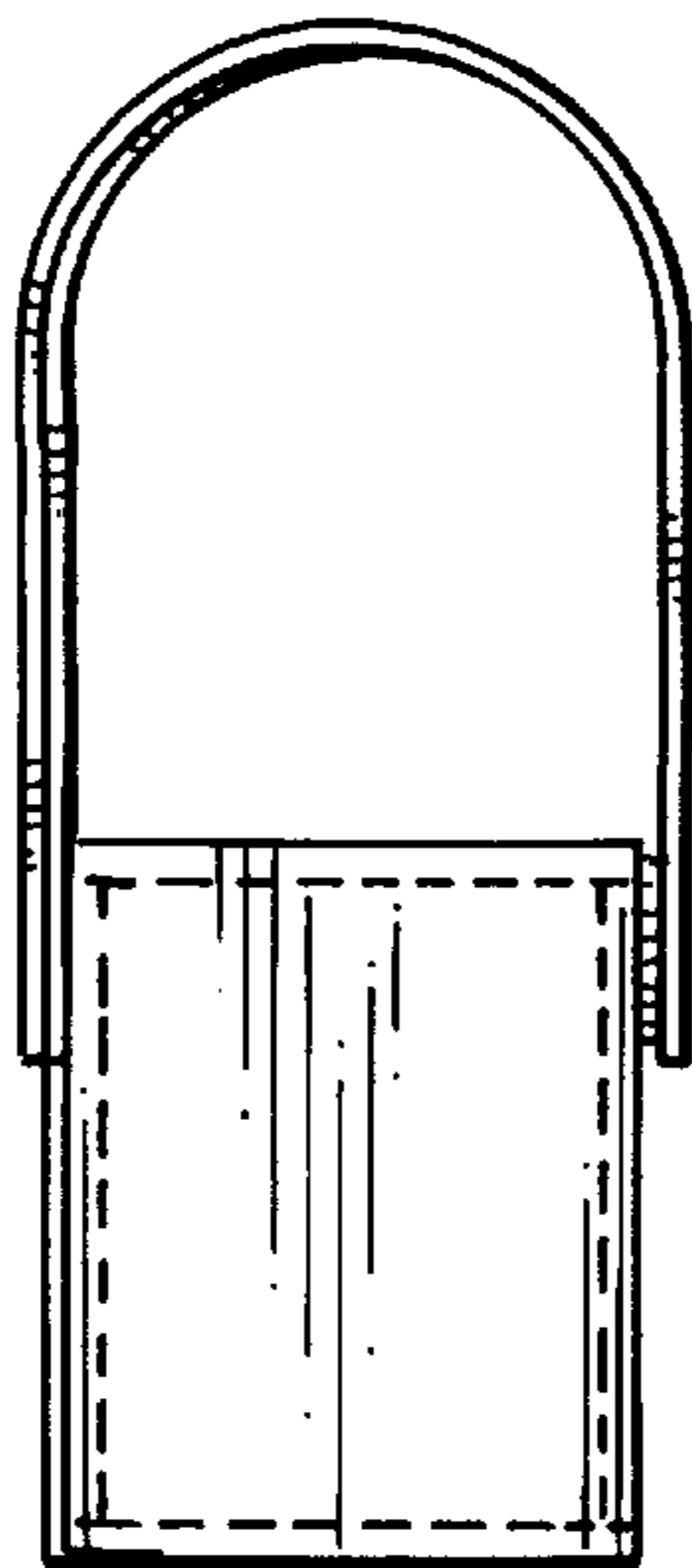

FIG. 5

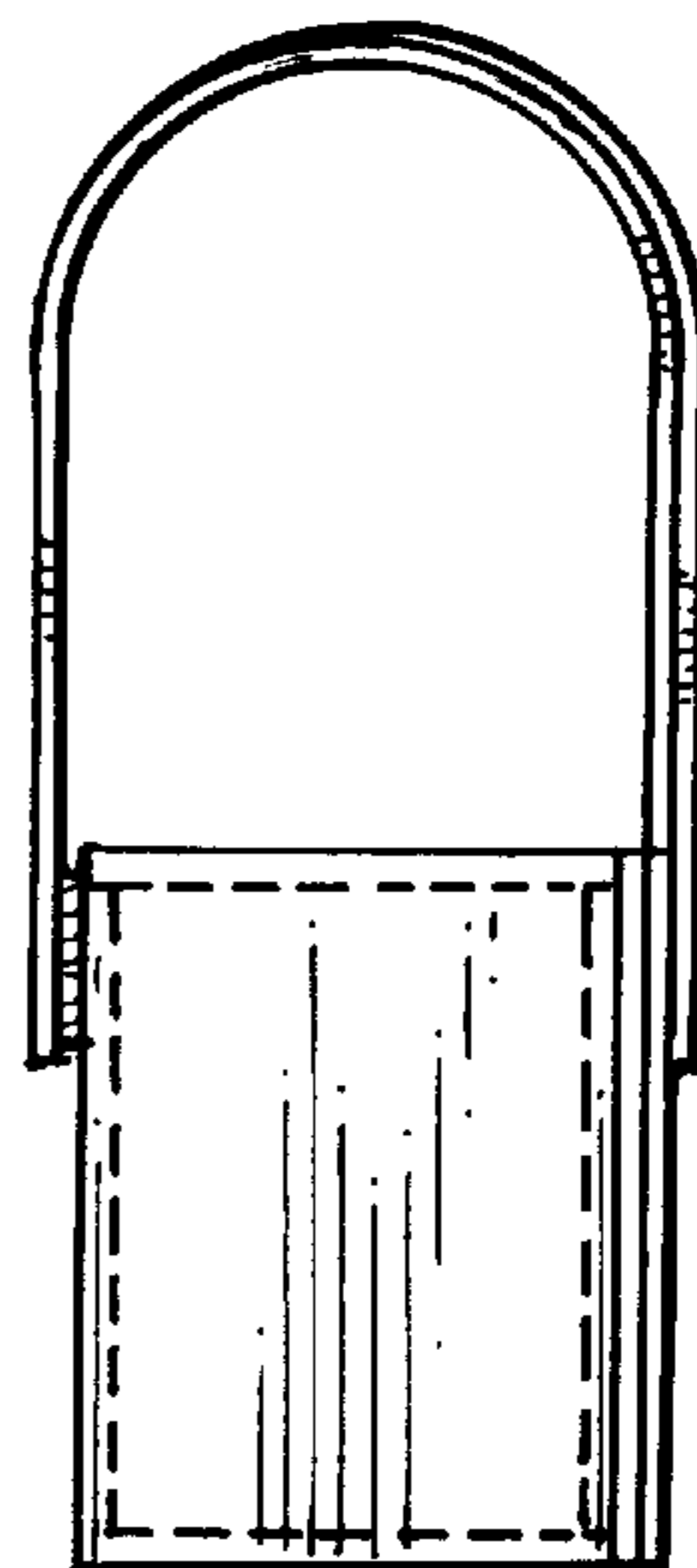
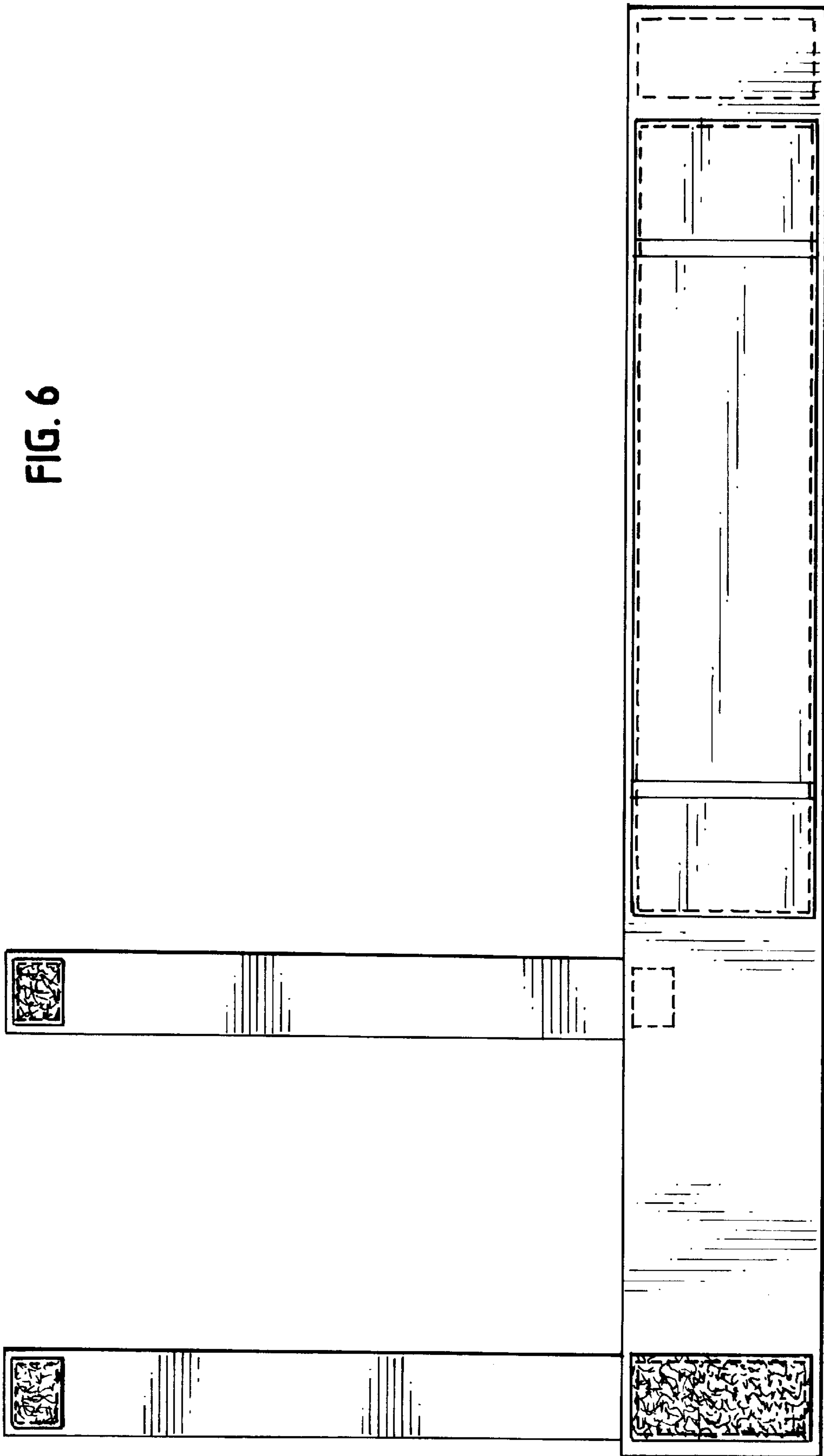

FIG. 6



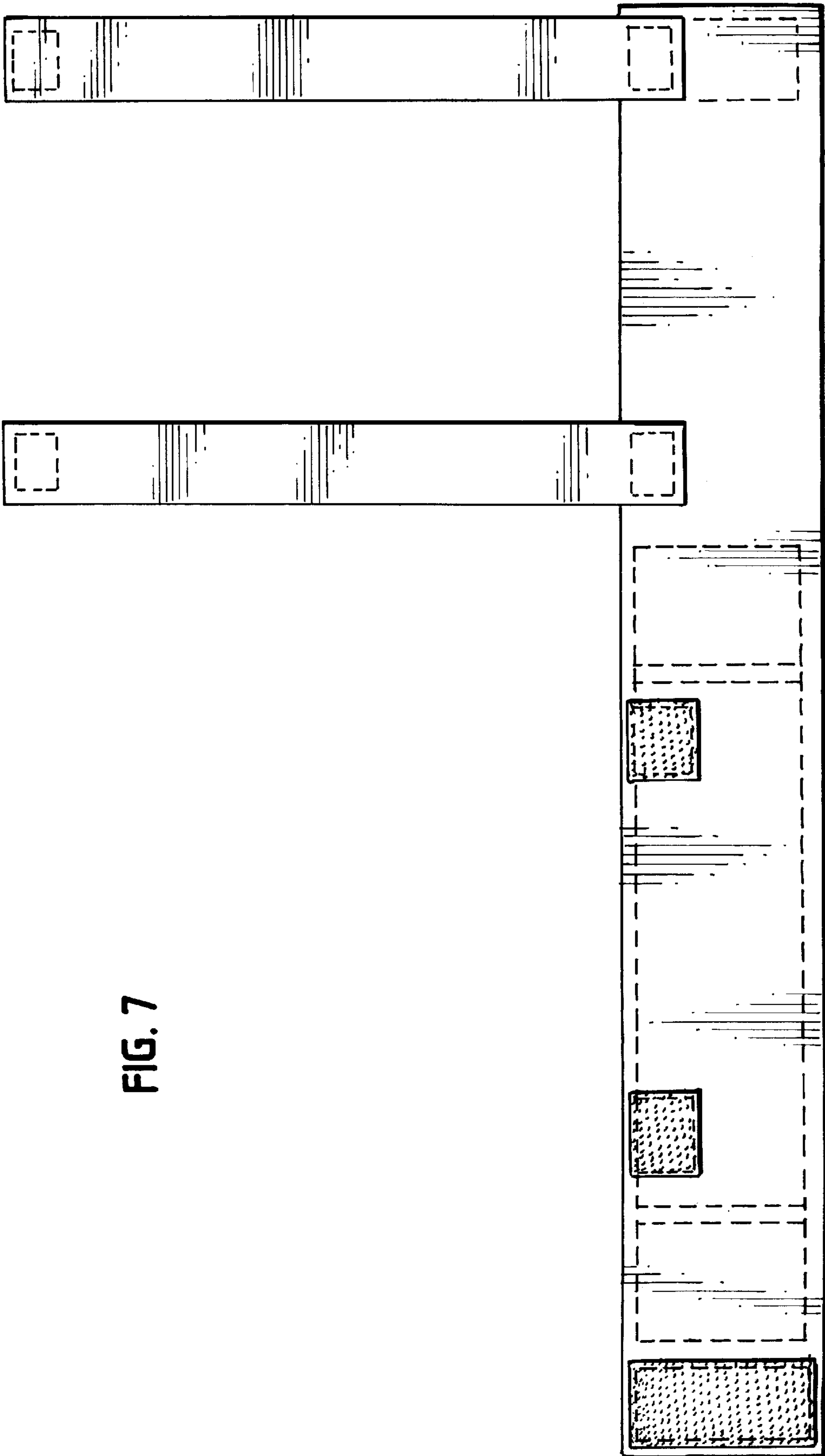

FIG. 7

**FIG. 8**

